

# Wastewater Treatment Plant Operator Certification Training



## Module 15: The Activated Sludge Process Part 1

This course includes content developed by the Pennsylvania Department of Environmental Protection (Pa. DEP) in cooperation with the following contractors, subcontractors, or grantees:

The Pennsylvania State Association of Township Supervisors (PSATS)  
Gannett Fleming, Inc.  
Dering Consulting Group  
Penn State Harrisburg Environmental Training Center



## Topical Outline

### Unit 1 – General Description of the Activated Sludge Process

- I. Definitions
  - A. Activated Sludge
  - B. Activated Sludge Process
  
- II. The Activated Sludge Process Description
  - A. Organisms
  - B. Secondary Clarification
  - C. Activated Sludge Process Control
  
- III. Activated Sludge Plants
  - A. Types of Plants
  - B. Factors that Upset Plant Operation
  
- IV. Unit Review
  
- V. References

### Unit 2 – Aeration

- I. Purpose of Aeration
  
- II. Aeration Methods
  - A. Mechanical
  - B. Diffused
  
- III. Aeration Systems
  - A. Mechanical Aeration Systems
  - B. Diffused Aeration Systems

- IV. Safety Procedures
  - A. Aeration Tanks and Clarifiers
  - B. Surface Aerators
  - C. Air Filters
  - D. Blowers
  - E. Air Distribution System
  - F. Air Headers and Diffusers
- V. Review
- VI. References

### Unit 3 – New Plant Start-Up Procedures

- I. Purpose of Plant and Equipment Review
  - A. Document Familiarization
  - B. Equipment Familiarization
- II. Equipment and Structures Check
  - A. Flow Control Gates and Valves
  - B. Piping and Channels
  - C. Weirs
  - D. Froth Control System
  - E. Air System
  - F. Secondary Clarifier
- III. Process Start-Up
  - A. Process Units
  - B. Process Control
- IV. Unit Review
- V. Reference

---

---

# Unit 1 - General Description of the Activated Sludge Process

---

---

## Learning Objectives

### Unit 1 – General Description of the Activated Sludge Process

- Describe the activated sludge process and its control variables.
- List three types of activated sludge treatment plants.

## Activated Sludge



**Activated sludge** consists of sludge particles, teeming with living organisms, produced in either raw or settled wastewater by the growth of organisms (which include bacteria) in aeration tanks where dissolved oxygen is present.

## Activated Sludge Process



The **Activated Sludge Process** is one of several biological wastewater treatment alternatives in Secondary Treatment. When Activated Sludge is added to wastewater, the organisms in this mixed liquor quickly decompose the wastes in the wastewater being treated. After a required period of aeration and agitation in the aeration tank, the mixed liquor usually flows to a separate tank called a clarifier where the activated sludge is allowed to settle out and the remaining liquid is discharged as effluent. The settled sludge is either disposed of as waste activated sludge or reused in the aeration tank as return activated sludge. Some sludge must always be returned to the aeration tanks to maintain an adequate population of organisms.

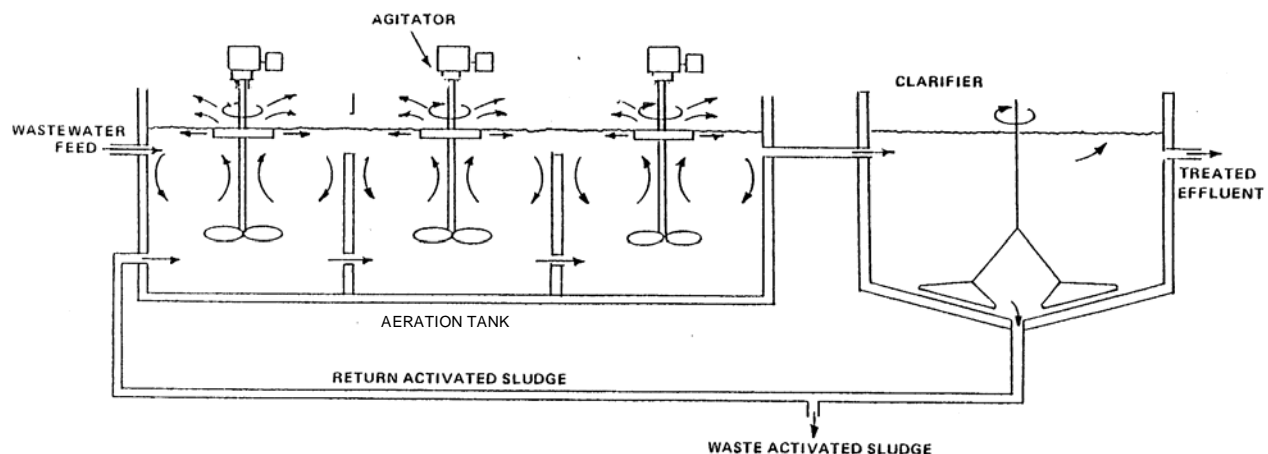

Figure 1.1 Diagram of aeration system in the activated sludge process<sup>1</sup>

- ✓ Process uses microorganisms to speed up decomposition of wastes.
  - Food is known as Biochemical Oxxygen Demand (BOD).
  - Organism mass is called Mixed Liquor Volatile Ssuspended Solids (MLVSS).

- ✓ When wastewater is added to activated sludge:
  - Microorganisms feed and grow on waste particles in the wastewater.
  - As organisms grow and reproduce, waste is removed and wastewater is partially cleaned.
  - Organisms need a balance of food (BOD) and oxygen. BOD is inherent in the wastewater and oxygen is added by aeration equipment.
  - The balance of food to organism mass is known as F/M ratio, food to microorganism ratio. An appropriate F/M ratio is necessary to obtain proper performance from the activated sludge process.
  
- ✓ Oxidation and removal of soluble or suspended solids is the result of the activated sludge process in waste treatment.
  - This treatment takes place in a few hours in an aeration tank.
  
- ✓ Stabilized soluble or suspended solids occur when organisms partially oxidize solids.
  - Organism activity forms carbon dioxide, water, sulfate, and nitrate compounds.
  - Remaining solids are changed to a form that can be settled and removed as sludge during sedimentation.
  
- ✓ For the activated sludge process to work properly, the operator must control the number of organisms and the dissolved oxygen level in the aeration tank, and the treatment time in the aeration tank. When these factors are under control, the process will operate as it should.



What purpose does the activated sludge process serve within wastewater treatment?

---

---

---

---

### Organisms

Activated sludge is full of many different living organisms that are responsible for the decomposition of wastes during the activated sludge process. The organisms are the workers in the activated sludge treatment process. They use the wastes as food and an energy source for survival and for reproduction.

The most effective and quickest decomposition of wastes is achieved by organisms that thrive in an oxygen-rich environment. These organisms are called aerobes and they require the presence of molecular oxygen,  $O_2$ , to survive. Another class of organisms found in activated sludge is facultative organisms, which can utilize either molecular oxygen or oxygen bound in inorganic compounds, such as nitrate,  $NO_3^-$ .

- **Aerobic** organisms are the most prominent organisms in an activated sludge plant. They...
  - Require a proper dissolved oxygen level (molecular oxygen,  $O_2$ ).
  - Produce little to no odor.
  - Efficiently oxidize waste.
  - Grow relatively quickly
- **Facultative** organisms grow in either an aerobic or an anaerobic (no oxygen) environment. They...
  - Are less efficient organisms for waste processing than aerobes.
  - Produce foul-smelling products of decomposition and incomplete reactions when oxygen is scarce.
  - Grow somewhat more slowly than aerobes.

An increase in the food (BOD) supply stimulates the organisms' activity and the rate of oxidation. More organisms are produced, which further increases activity. Because the organisms need oxygen to maintain their activity and survive, the increased food supply creates a demand for more oxygen, which must be provided by the aeration system. This underscores the need to maintain a proper F/M ratio for stable operation of the activated sludge process and the ability to adjust the aeration rate as the oxygen demand varies.



## Secondary Clarification

### Secondary Clarifier Operation

Secondary Clarification is the physical process of removing microorganisms and solids from treated wastewater. The purpose of the clarifier is to produce a clear effluent suitable for discharge, to remove excess organisms from the activated sludge system, and to provide a source of organisms to return to the activated sludge process as required.

Typical rectangular clarifiers are shown in Figure 1.2.

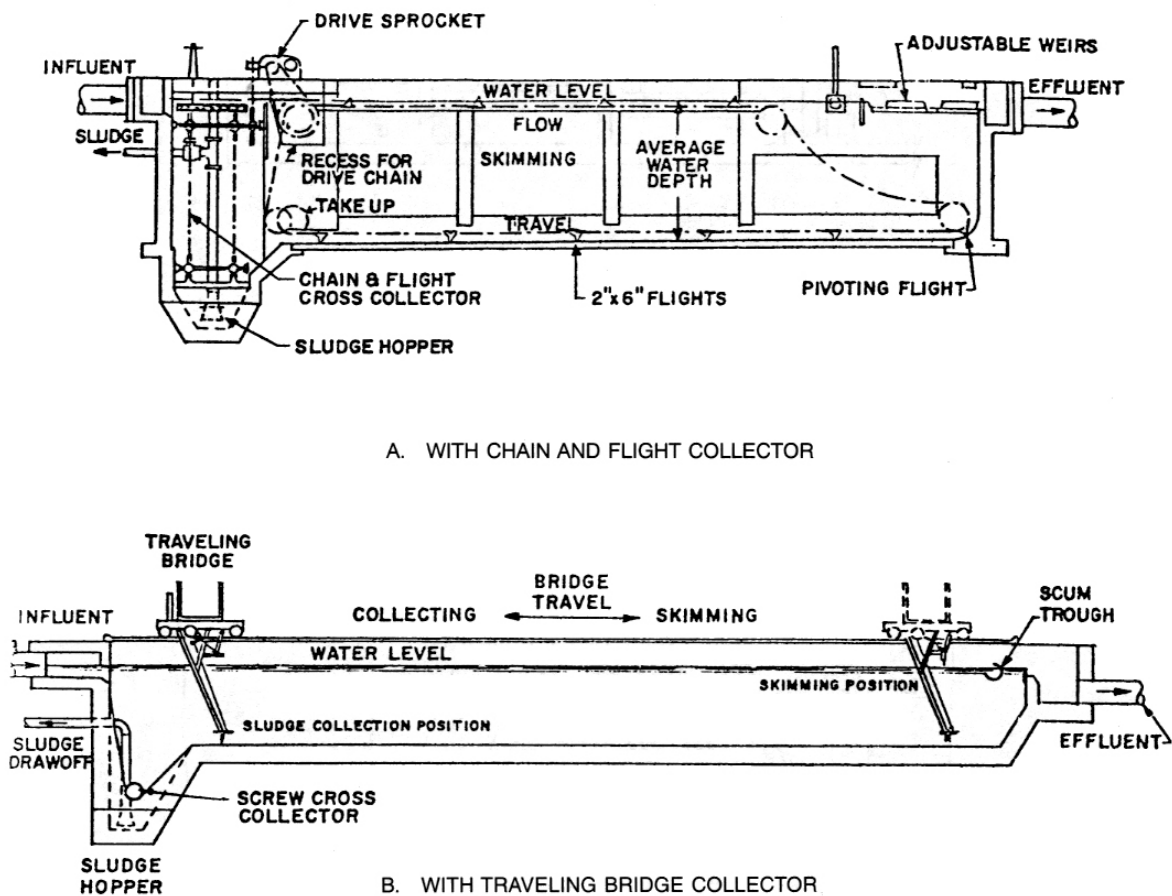

Figure 1.2 Rectangular Sedimentation Clarifiers: Chain and Flight (top) and Traveling Bridge (bottom) <sup>2</sup>

# THE ACTIVATED SLUDGE PROCESS DESCRIPTION

Typical circular clarifiers are shown in Figure 1.3.

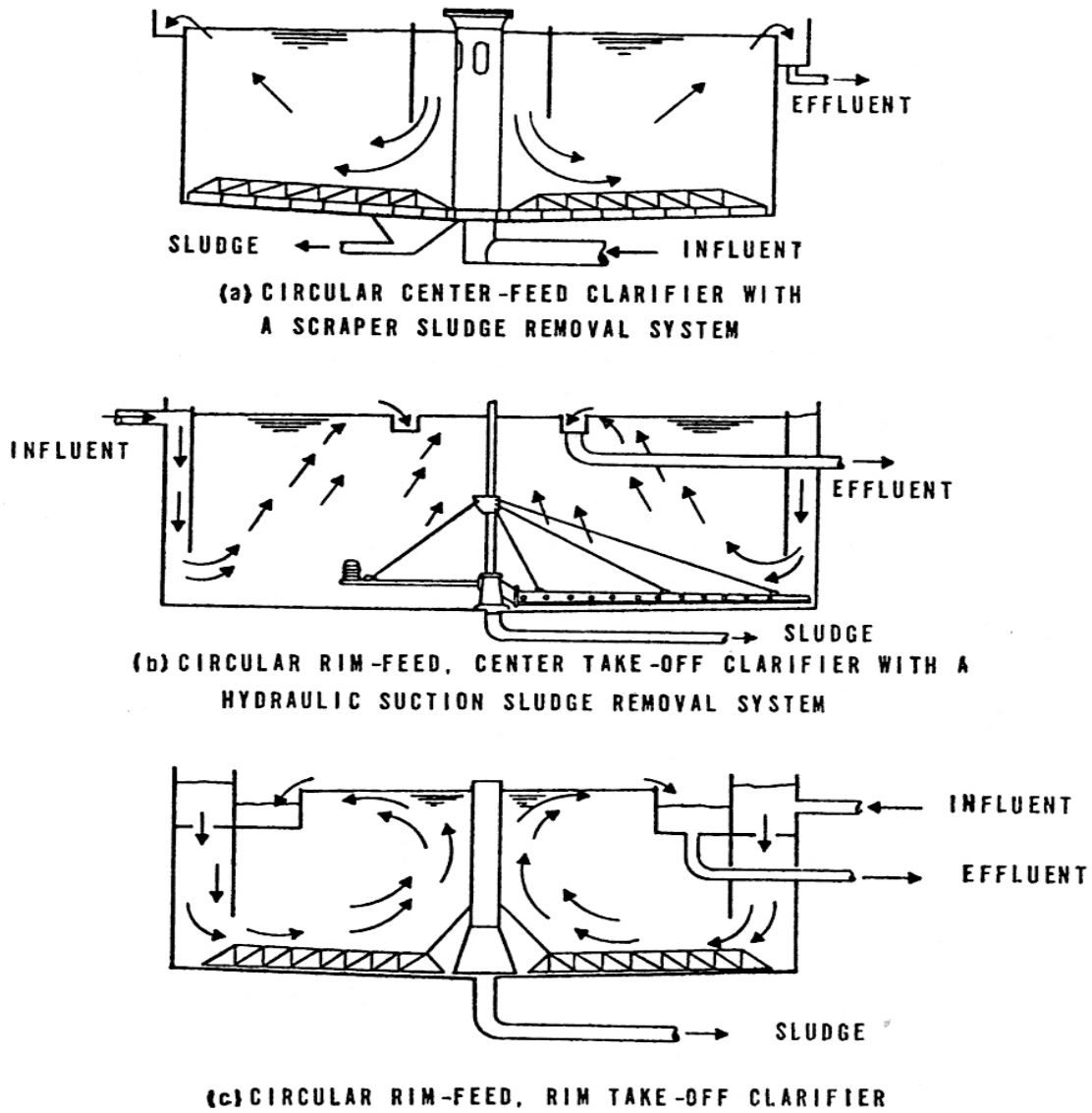

Figure 1.3 Typical Circular Clarifiers<sup>3</sup>

# THE ACTIVATED SLUDGE PROCESS DESCRIPTION

How the operator manages the clarifier sludge will have an impact on how well the activated sludge process works. The clarified sludge will either be returned to the aeration tank or disposed of as waste.

## Return Activated Sludge

Return Activated Sludge (RAS) refers to the sludge settled in the clarifier that is returned to the aeration tank.

Proper management of RAS is important to the efficiency of the activated sludge process because:

- RAS provides a source of organisms that is returned to the activated sludge process as required.
- By changing the RAS rate, the operator can control the concentration of organisms in the aeration tank in response to the food supply present in the incoming wastewater. This allows him to maintain the proper F/M ratio for good system performance.
- The well-being of the aerobic organisms deteriorate as long as they remain in the secondary clarifier. If the sludge remains in the clarifier too long, the aerobic organisms will die for lack of oxygen.
- Caution has to be taken when increasing RAS rates because hydraulic overloading of the activated sludge system can occur. Increasing the RAS rates increases the volume in the aeration tank and in turn decreases the hydraulic detention time.

## Waste Activated Sludge

Waste Activated Sludge (WAS) is the sludge removed from the system to prevent buildup of excessive solids in the aeration tank and in the activated sludge process. This sludge is disposed of at the plant's sludge disposal facility and is not reused in the process. Table 1.1 shows Standard Operating Procedures for WAS Control for three common activated sludge modifications.

METHOD OF CONTROL	PROCESS OPERATION	WHAT TO CHECK	WHEN TO CHECK	CALCULATION	FREQUENCY OF ADJUSTMENT	CONDITION	PROBABLE CAUSE	RESPONSE <sup>a</sup>
F/M	High Rate	MLVSS & Influent COD	Daily	F/M Based on 7-Day Avg. COD 7-Day Avg. MLVSS	Daily	Actual F/M: High	Excessive Wasting	Reduce WAS
	Conventional Rate					Satisfactory	—	
	Extended Aeration					Low	Insufficient Wasting	Increase WAS
MLVSS	High Rate	MLVSS & Influent COD or BOD	Daily	Volatile Solids Inventory	Daily	Actual MLVSS: High	Insufficient Wasting	Increase WAS
	Conventional Rate					Satisfactory	—	
	Extended Aeration					Low	Excessive Wasting	Reduce WAS
MCRT	High Rate	MLSS, WAS <sub>SS</sub> , Q <sub>WAS</sub> , EFFL <sub>SS</sub>	Daily	7-Day Avg <sup>b</sup> Solids Inventory	Daily	Actual MCRT: High	Insufficient Wasting	Increase WAS
	Conventional Rate			7-Day Average <sup>b</sup> of Solids in WAS		Satisfactory	—	
	Extended Aeration			7-Day Average <sup>b</sup> of Solids in Effluent		Low	Excessive Wasting	Reduce WAS
Sludge Age	High Rate	Influent SS, & MLSS	Daily	7-Day Avg of SS Inventory & SS in Influent	Daily	Actual SA: High	Insufficient Wasting	Increase WAS
	Conventional Rate					Satisfactory	—	
	Extended Aeration					Low	Excessive Wasting	Reduce WAS

<sup>a</sup> Response — Calculations should be made to determine the WAS rate. However, when increasing or decreasing daily WAS rates, any changes should not exceed 10 to 15 percent of the previous day's WAS rate. This is necessary to allow the process to stabilize.

<sup>b</sup> When calculating the MCRT, determine the desired MCRT (5 days) and use the moving average for the number of days (7 days) to calculate values used in the formula to determine the desired MCRT.

Table 1.1 Standard operating procedures for WAS control<sup>4</sup>

## Activated Sludge Process Control

An activated sludge plant requires influent water quality testing and activated sludge process testing to insure proper treatment.

### Incoming Wastewater Testing

Monitoring of influent wastewater is an important component of operating an activated sludge plant.

- Influent BOD testing will allow monitoring of F/M ratio and plant organic loading.
- The water quality parameters of pH and alkalinity and the presence of toxic substances can impact plant operation, because of their impact on the health of the organisms.
- The incoming wastewater flow rate will impact the organic loading on the plant.



What happens to the air requirement in the aeration tank when the strength (BOD) of the incoming wastewater increases?

---

---

---

---

### Activated Sludge Process Testing

A number of process variables will impact the performance of the activated sludge process. These include the mass of organisms in the aeration tank or activated sludge concentration, the sludge age, the dissolved oxygen concentration, the proper distribution of flow to parallel treatment units, and management of return activated sludge (RAS) and waste activated sludge (WAS). A brief discussion of each parameter follows.

#### ☐ *Activated Sludge Concentration*

The mass of microorganisms is a component to be monitored and adjusted for good plant operation.

- The Mixed Liquor Volatile Suspended Solids (MLVSS) concentration is a measure of the concentration of organisms present in the mixed liquor. The test for MLVSS first requires the determination of the MLSS concentration. The MLVSS is a fractional percentage of the MLSS.
- Perform 30-minute settleability tests in conjunction with MLSS testing. A general correlation between the two tests may be derived. The 30-minute test may then be used more frequently to assist in process control of aeration tank solids levels due to the short time required to conduct the test.

#### ☐ Activated Sludge Age

Sludge age is a measure of the time a particle of suspended solids has been retained in the activated sludge process. Managing the age of activated sludge is a very important component of the operation of an activated sludge plant. Changing the sludge age changes the population dynamics of the organisms in the activated sludge process.

- Sludge age can impact BOD removal.
- Sludge age can impact the clarifier operation and solids settleability.
- Sludge age can impact the oxygen requirements of the activated sludge process.
- Sludge age can impact sludge production. An older sludge will produce less.

Sludge age equation:

$$\text{Sludge age, days} = \frac{\text{Suspended solids under aeration, lbs}}{\text{Suspended solids added, lb/day}}$$

Sludge age is alternatively calculated using all the sludge in the activated sludge process, including the aeration tank and the clarifier and any additional re-aeration tanks.

## THE ACTIVATED SLUDGE PROCESS DESCRIPTION

---



Calculate the sludge age for an activated sludge process if the aeration volume is 0.5 million gallons (MG) and the mixed liquor suspended solids concentration is 2,100 mg/L. The influent flow is 4.0 MG per day and the primary effluent suspended solids concentration is 70 mg/L.

---

---

---

---

***Dissolved Oxygen Levels***

The organisms in an activated sludge plant need a satisfactory level of dissolved oxygen (DO) to function efficiently.

- Low DO in the aeration tank will reduce the activity of aerobes.
- Low DO levels may promote the growth of filamentous and other unwanted organisms.
- High DO in the aeration tank will promote the growth of organisms responsible for pin floc formation, which adversely impacts sludge settling

***Flow Splitting Where Sufficient Loadings Exist***

When duplicate plant units exist, accurate flow splitting is important to achieve consistent operation and effluent quality.

- A hydraulic imbalance can cause an organic overload and overcome the design capability of a specific unit.
- Unbalanced flows and organic load can impact the operation of aeration tanks and clarifiers.
- Unbalanced flows and organic load can affect the activated sludge process by impacting sludge volumes, sludge age, and F/M ratio.
- Uneven flows may cause overfeeding or starvation that may upset the activated sludge process.

***Solids Handling: Return and Waste Sludge***

Solids handling is an important function in operating an activated sludge plant. As discussed previously, sludge from the clarifier is either returned to the aeration tank or disposed of. The proper balance between WAS and RAS is required to provide the proper amount of organisms for the aeration tank in response to the incoming wastewater characteristics.

## Activated Sludge Plants

There are three basic operational modes for activated sludge plants, based on the sludge age maintained in the process.

- High Rate (Modified Aeration),
- Conventional, and
- Extended Aeration.

### High Rate

A high rate process is used when the discharge quality needs to be greater than that of raw wastewater or wastewater that has undergone only primary treatment, but not as great as that obtained by a conventional activated sludge process.

A high rate activated sludge treatment plant is operated so that the amount of food available exceeds the capacity of the organisms to stabilize it. It is characterized by:

- High F/M ratio (0.4 to 1.5).
- Short sludge age (0.5 – 5 days).
- High organism growth rate.
- 1 to 3 hour hydraulic retention time.
- Lower than desirable effluent quality (because some food passes through the process without being stabilized by the organisms).

The chief benefit of a high rate plant is the rapid uptake of food from the wastewater into the organism biomass.

Detriments of a high rate plant include:

- Relatively high BOD and suspended solids in the effluent.
- High sludge production rate.
- Requires more operator attention and monitoring of process parameters.
- More easily upset than other processes.

### **Conventional**

A conventional activated sludge treatment plant is operated so that the amount of food available for the organisms is limited, requiring the organisms to compete for the available food. It is characterized by:

- Moderate F/M ratio (0.2 to 0.4).
- A mid-range sludge age of approximately 3.5 – 10 days.
- A slow organism growth rate.
- Hydraulic retention time of 6 to 8 hours.
- A good quality effluent because any available food is processed by the organisms.

The chief benefits of a conventional activated sludge treatment plant are:

- The high quality of the effluent.
- Its ability to absorb some shock loads.

Detriments of conventional activated sludge plants are relative compared to a high rate process and involve trade-offs. A conventional process requires more tank volume and greater oxygen requirements per pound of BOD processed compared to a high rate process. Consequently the activated sludge plant itself is more expensive, but ancillary treatment processes are less expensive (such as sludge processing), and process control requirements are less demanding.

### **Extended Aeration**

An extended aeration treatment plant is operated so that the amount of food introduced into the process is not sufficient to support net organism growth (i.e. organisms die at a rate equal to their growth rate). In this mode, the organisms must obtain some of their food by breaking down their own cellular material. It is characterized by:

- Low F/M ratio (0.05 to 0.15).
- A relatively long sludge age, generally more than 10 days and often 20 to 30 days.
- A zero net organism growth rate.
- A relatively long hydraulic retention time of 18 to 24 hours.



The chief benefits of extended aeration are:

- The stability of the process.
- Less demanding operational requirements.
- High quality of the effluent (because complete oxidation of food occurs).
- Low sludge production rate.
- Often nitrification will occur if the sludge age is on the longer end of the range.

The chief detriment of extended aeration is the expense of building an extended aeration plant (because of the large size of the tank needed to provide the requisite hydraulic retention time of 18 to 24 hours.)

### Variables That Impact Plant Operation

The task of the activated sludge treatment plant operator is to provide the proper environment for the efficient conversion of colloidal and dissolved solids into settleable biological floc. However, both the influent wastewater quality and plant processes can impact this process and consequently, the plant effluent quality. Some of these variables include:

- Influent BOD and changing waste characteristics:
  - High BOD levels can cause an organic overload.
  - A change in influent temperature or pH can change biological reaction rates and the normal equilibrium of wastewater constituents, potentially changing the availability of food for organisms or the rate at which they can process it.
  - Introduction of toxic substances in the wastewater influent can kill or inhibit organisms.
- Waste Activated Sludge Rate
  - Changing the rate at which sludge is wasted changes the nature of the organisms that predominate in the activated sludge plant.
  - The rate at which activated sludge is wasted needs to be managed in accordance with daily or seasonal variations in BOD loading (to properly balance the F/M ratio) and also to react to sudden or shock loads of BOD to the system.

- Dissolved Oxygen Level
  - Low DO levels in the aeration tank can inhibit the activity of desired organisms and allow undesirable (i.e., facultative and filamentous) organisms to thrive.
  - Changes in the organic strength (amount of food) in the influent will cause changes in the oxygen requirements for the activated sludge system. The operator or the system needs to be able to respond to these changes to maintain the proper dissolved oxygen concentration to support the organisms without over-aerating the wastewater.
  - The oxygen transfer rate is dependant on the temperature of the liquid in the aeration tank and the size of the air bubbles. The transfer rate of oxygen increases as the temperature of the liquid and size of the air bubbles decreases, and vice versa.

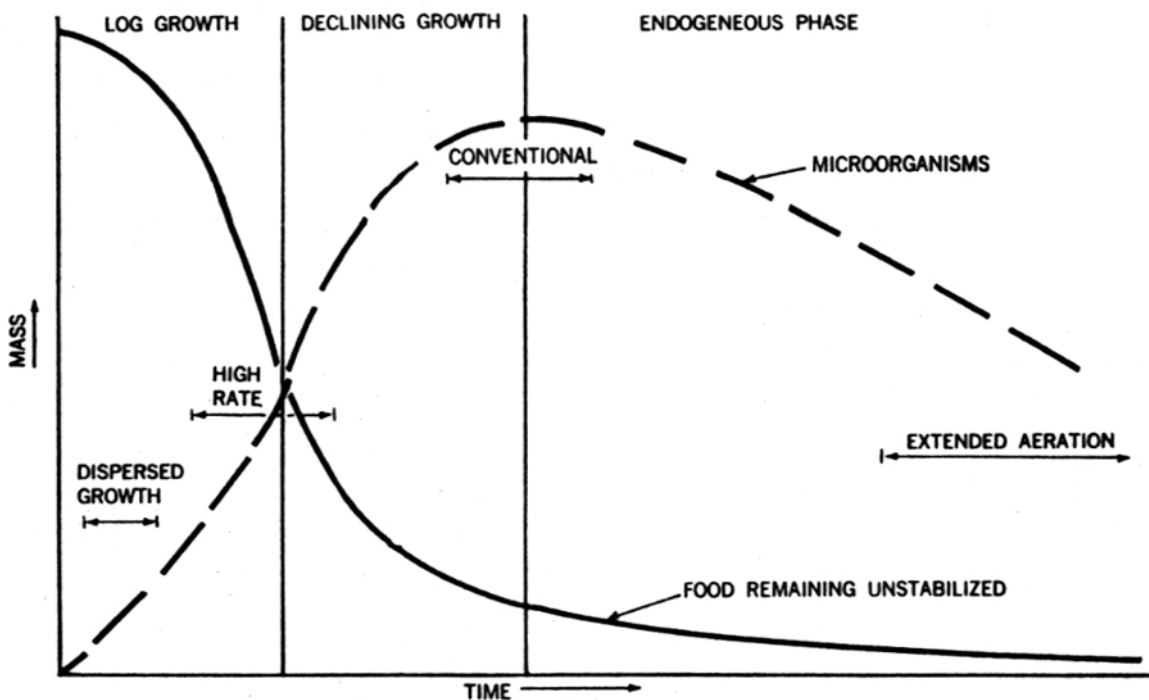

Figure 1.4. Ideal growth curve for Batch-type activated sludge unit.<sup>5</sup>



### Key Points for Unit 1 – General Description of the Activated Sludge Process

- The activated sludge process is biological in nature and usually requires the addition of dissolved oxygen to the wastewater.
- Aerobic organisms are usually used in activated sludge plants, produce little odor, and require a proper amount of dissolved oxygen (DO) to function properly.
- Facultative organisms can grow with or without dissolved oxygen (DO) but are less efficient than aerobic organisms and often produce foul-smelling products.
- Secondary clarifiers remove microorganisms and solids from treated wastewater.
- Returned Activated Sludge (RAS) is settled sludge taken from the bottom of the clarifier tank and returned to the aeration tank. RAS provides an important source of microorganisms needed for the treatment process.
- Caution has to be taken when increasing RAS rates because hydraulic overloading of the activated sludge system can occur. Increasing the RAS rates increases the volume in the aeration tank and in turn decreases the hydraulic detention time.
- Waste Activated Sludge (WAS) is removed from the treatment process and disposed of or “wasted” to prevent an excessive build-up of solids in the treatment process.
- Sludge age is a measure of the time a particle of suspended solids has been retained in the activated sludge process, with changes in sludge age changing the dynamics of the organisms in the activated sludge process.
- Influent wastewater is usually monitored for BOD, pH, alkalinity, flow rate, and toxic substances since all of these can affect the plant operation efficiency.
- The three basic types of activated sludge plants are:
  - High Rate (Modified Aeration)
  - Conventional
  - Extended Aeration
- Plant efficiency is affected by both the quality of the wastewater influent as well as changes in the plant processes.
- Low DO levels in the aeration tank can allow the growth of undesirable filamentous and facultative bacteria.
- The transfer rate of oxygen increases as the temperature of the liquid decreases and the size of the air bubbles decreases, and vice versa.



Exercise for Unit 1 – General Description of the Activated Sludge Process

1. Why is air added to the aeration tank in the activated sludge process?

---

---

---

---

2. What does the volatile content of the mixed liquor suspended solids represent?

---

---

---

---

3. What influences the amount of air required in an aeration tank?

---

---

---

---

4. Aerobic organisms grow relatively quickly, efficiently oxidize waste, produce little or no odor, but require a proper amount of dissolved oxygen to function properly.

- a. True
- b. False

5. The conventional activated sludge process produces a high quality of effluent and the process has some ability to absorb \_\_\_\_\_ loads.

6. As the water temperature drops, water will be able to dissolve:

- a. more oxygen
- b. less oxygen

<sup>1</sup>Figure 1.1 Diagram of aeration system in the activated sludge process<sup>1</sup> [Adapted from Figure 2.3 Schematic diagram, p. 56, from *Advance Waste Treatment*, 3<sup>rd</sup> Edition (Sacramento)]

<sup>2</sup> Figure 1.3 from Paul Amodeo, Ross Gudgel, James L. Johnson, Paul J. Kemp, Robert G. Blanck and Francis J. Brady, "Chapter 4: Solids Removal from Secondary Effluents," in *Advance Waste Treatment*, (Sacramento, CA: California State University, Sacramento Foundation, 1998), p. 354.

<sup>3</sup> Figure 1.4 from Amodeo, p. 355.

<sup>4</sup>Table 1.1 Standard operating procedures for WAS control<sup>4</sup> [Table 2.4, p. 70, from *Advance Waste Treatment*, 3<sup>rd</sup> Edition (Sacramento)]

<sup>5</sup>Figure 1.5 Ideal growth curve for a batch-type activated sludge unit.<sup>5</sup> [Source; MOP 11, *Operation of Wastewater Treatment Plants, a manual of practice*, Water Environment Control Federation, 1976 Edition)

(This page was intentionally left blank.)

## Unit 2 – Aeration

---

---

### Learning Objectives

- Explain the purpose and methods of aeration.
- Describe how mechanical aeration works.
- Describe the three types of diffusers.
- Describe plant safety procedures around an aeration tank.

### Purpose of Aeration

The purpose of aeration is two fold: 1) to dissolve oxygen into the wastewater in the aeration tank and 2) to intermix the mixed liquor suspended solids in the aeration tank with the incoming wastewater.

### Aeration Methods

In wastewater treatment plants there are two methods of aeration: Mechanical and Diffused. Each of these methods has its own system for delivery of air and mixing the mixed liquor with the wastewater.

- **Mechanical:** uses devices to either splash water into the air or mix air into the wastewater.
- **Diffused:** disperses compressed air to provide both oxygen to and the mixing of wastewater.



## Mechanical Aeration Systems

Most mechanical aeration equipment works in a similar manner.

### Equipment Is Designed To:

- Agitate the water surface in the aeration tank to cause spray and waves, which enhances the transfer of oxygen from the atmosphere into the wastewater.
- Splash water into the air or entrain (mix) air into the water to enhance the transfer of oxygen into the wastewater.
- Mix the incoming wastewater, the mixed liquor suspended solids, and the air bubbles in the aeration tank to enhance the aeration process.

Simple mechanical aeration devices either splash water into the air or entrain (mix) air into the wastewater so that oxygen can be absorbed into the water. Mechanical aerators typically:

- Use an electric motor for power
- May be of a fixed-location design (i.e., platform-mounted) or a floating design.
- Use a submerged or partially submerged impeller or splashing device

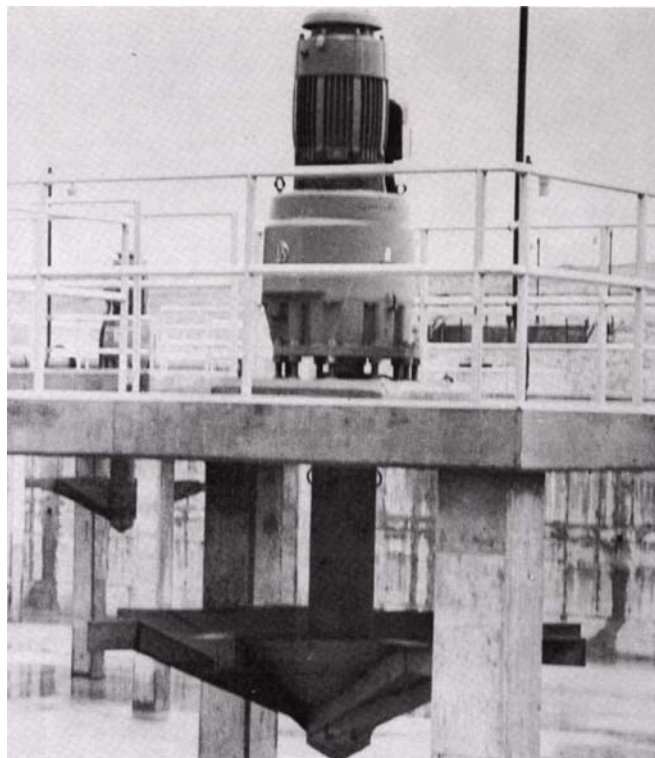

Figure 2.1 Mechanical Aeration Device<sup>1</sup>

### Equipment Can Consist of:

- Horizontally-oriented paddlewheels or rotating brushes, or
- Vertically-oriented mixers or turbines

### Submerged Turbine Aerators

Are commonly-used hybrid mechanical aerators that also incorporate:

- Submerged impellers.
- Diffused air that is dispersed beneath the aerator.
- Draft tube to induce a more effective flow pattern for transferring oxygen to the wastewater.

## Diffused Aeration Systems

Diffused aeration systems are the most common type of aeration systems used in the activated sludge process. These systems utilize pressurized air supplied to a galley of distribution devices (diffusers) submerged in the aeration tank.

- Blowers are the devices that provide the pressurized air.
- Air piping transports the pressurized air from the blowers to the diffusers.
- Diffusers are the devices that distribute the air within the aeration tank.

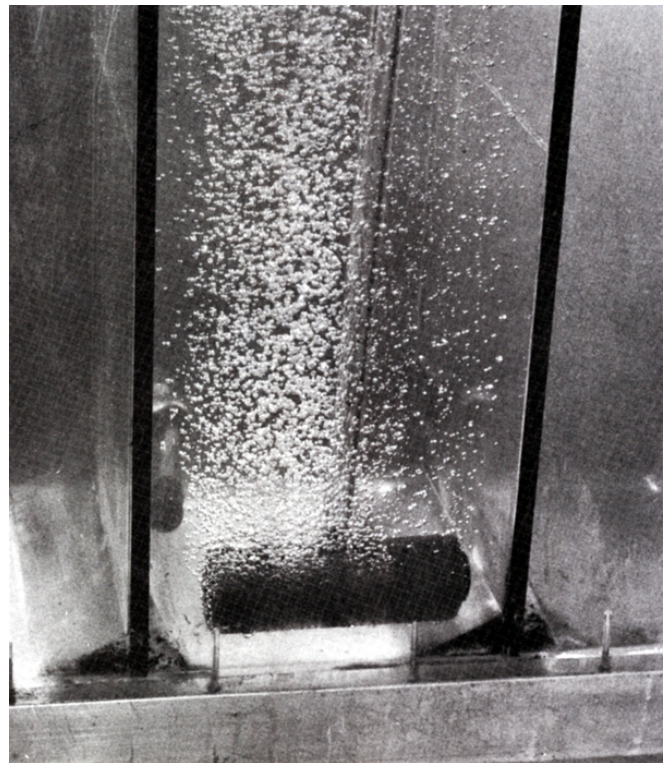

Figure 2.2 Fine Bubble Air Diffuser <sup>2</sup>

Diffused aeration systems utilize diffusers, blowers, transfer piping, and other associated equipment to transfer oxygen into the wastewater. The diffusers are designed to release a continuous supply of bubbles into the wastewater. Air from inside the bubbles dissolves into the wastewater. The amount of air that is transferred increases as both the contact time with the wastewater and the surface area of the bubbles increase. Therefore, increasing the submergence depth of the diffusers and reducing the size of the air bubbles, for a given air volume, will increase the rate at which air is dissolved into the wastewater.

Placement of the diffusers in the aeration tank can optimize the contact time between bubbles and wastewater. This is done by inducing a rolling pattern that keeps the bubbles submerged longer. The induced rolling pattern is also required to adequately mix the mixed liquor suspended solids with the incoming wastewater and the bubbles. When this occurs, the solids do not settle and intimate contact is maintained in order for the processes of decomposition, started by the microorganisms, to proceed effectively.

Selected components of a diffused aeration system are discussed in the following sections.

### Filters

Continued effective operation of a diffused aeration system requires the air provided to the diffusers be clean. Without clean air the relatively small openings in the diffusers would become clogged causing a reduction in the air flow and a consequent decrease in the oxygen transfer rate. The primary purpose of filters is therefore to keep the diffusers clean by removing dust and dirt before air is compressed and transferred to the diffusers. In addition filters:

- Prevent large objects from entering the piping and possibly damaging the blowers.
  
- When constructed with integral silencers, they control the noise inherent in the operation of blowers.

## Blowers

Blowers for aeration systems, which are sometimes referred to as process air compressors, are generally either a positive displacement type or a centrifugal type.

### ☐ Positive Displacement Blowers

- Characterized by:
  - A rotating set of lobes or rotors that provide a constant volume of air per revolution, within the operating pressure range of the blower, for each specific lobe design.
  - A relatively low operating speed, known as revolutions per minute (RPMs) compared to centrifugal blowers, and
  - A relatively smaller unit capacity compared to centrifugal blowers.
- Output Control Mechanisms:
  - Change the motor RPM for a motor directly connected to the blower. This can be done by physically replacing one motor with another or by changing the electrical frequency applied to the drive motor via a frequency control device, if a variable frequency drive (VFD) is used.
  - Adjust the speed using a magnetic drive coupling.
  - Change the pulley wheel (sheave) sizes for blowers connected to motors with drive belts.
  - Change the gear ratio for blowers connected to motors via a gearbox.
  - Change the lobes or rotors in the blower.

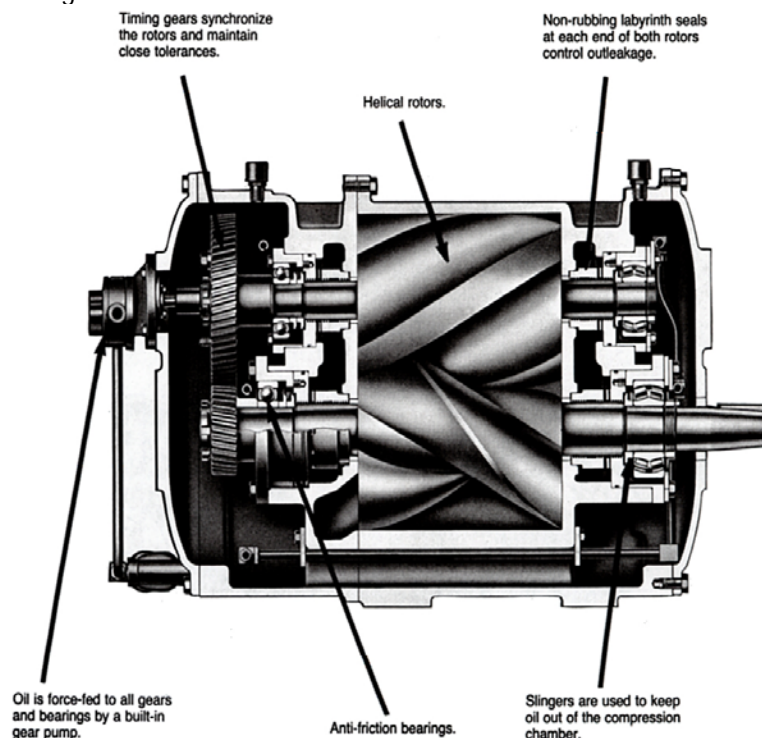

Figure 2.3 Rotary Positive Displacement Blower<sup>3</sup>

### ☐ Centrifugal Blowers

- Characterized by:
  - A rotating impeller that provides a variable volume of air per revolution, depending on the output pressure required.
  - A relatively high operating speed, revolutions per minute (RPMs,) compared to positive displacement blowers.
  - A relatively larger unit capacity compared to positive displacement blowers.
  
- Output Control Mechanisms:
  - Change the motor RPM for a motor directly connected to the blower. This can be done by physically replacing one motor with another or by changing the electrical frequency applied to the drive motor via a frequency control device, if a variable frequency drive (VFD) is used.
  - Adjust the speed using a magnetic drive coupling.
  - Change the pulley wheel sizes for blowers connected to motors with drive belts.
  - Change the gear ratio for blowers connected to motors via a gearbox.
  - Change the pressure requirements for the aeration system. Decreasing the pressure required will increase the output of the blower and increasing the pressure required will decrease the blower output.
  - Change the impeller size or design.

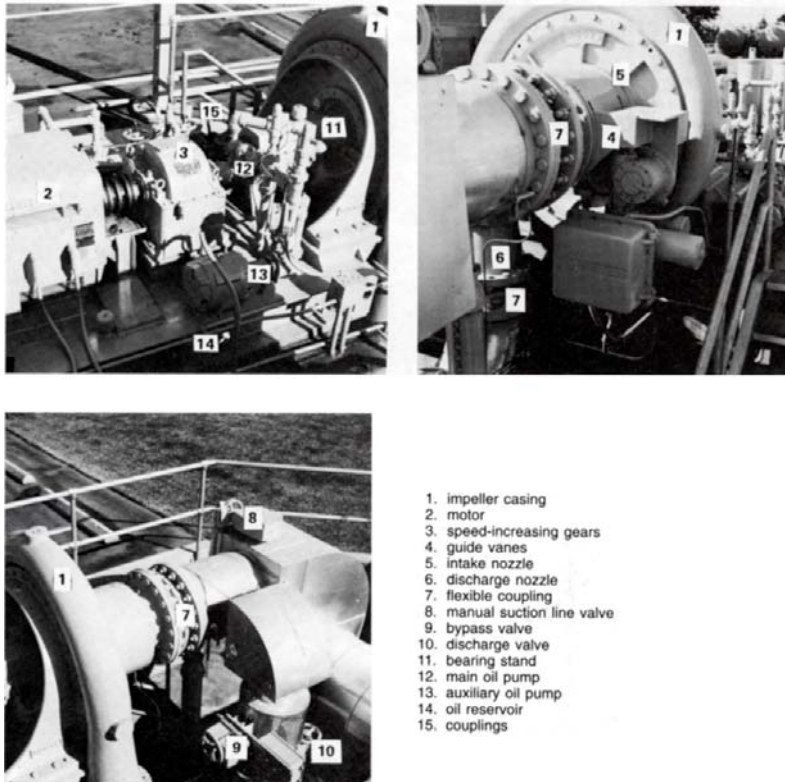
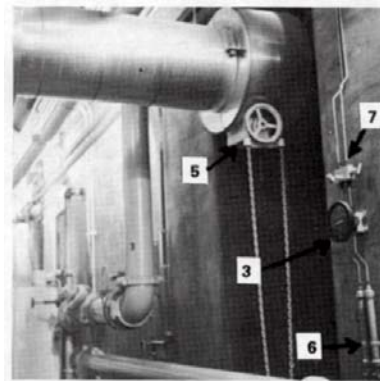

Figure 2.4 Centrifugal Blower<sup>4</sup>

## Air Piping Systems

The air piping system consists of pipes, valves, and metering devices that deliver air from the blowers to the diffusers in the aeration tanks.



Air distribution piping entering Y-wall of a large activated sludge plant.

1. orifice plate between pipe flanges
2. meter tubing
3. meter
4. air headers
5. air regulating/isolation valve
6. condensate traps
7. meter manifold valves
8. meter air supply tubing take-off valves

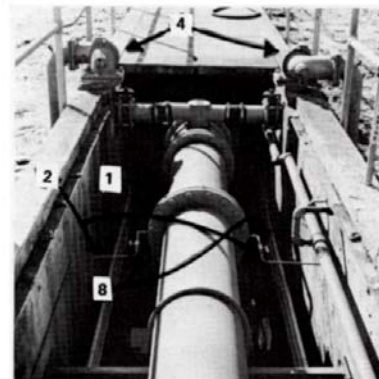
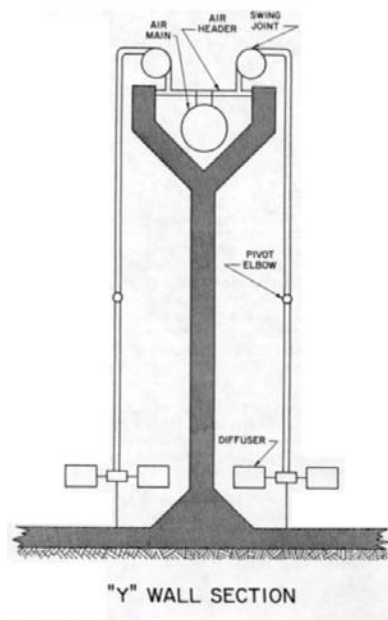

Air distribution piping in the Y-wall of a large activated sludge plant connected to air headers.

Figure 2.5 Air Distribution Piping<sup>5</sup>

Air mains are the large arteries of the piping system that transfer the bulk of the air from the blowers to the smaller distribution pipes.

Air headers are smaller distribution pipes that transfer air from the mains usually to several air branch lines connected to the header.

The air lines that distribute the air from an air header to the air diffusers are sometimes referred to as headers also, if they supply air to a number of diffusers mounted on branch air lines.

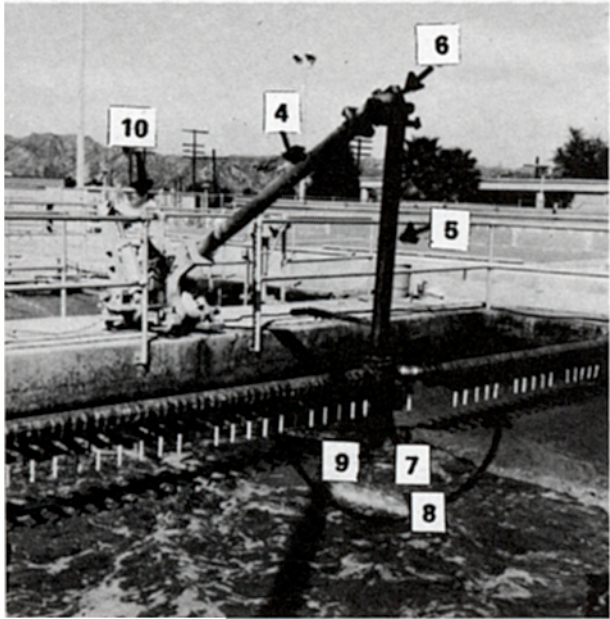

1. distribution system connector fittings
2. header valve—regulating and isolation
3. double pivot upper swing joint
4. upper riser pipe
5. lower riser pipe
6. pivot elbow
7. leveling tee
8. horizontal air header
9. air blowoff leg
10. hoist

Swing header

Figure 2.6 Swing Header<sup>6</sup>

Sometimes these air lines are equipped with swivel joints that allow them to be pulled out of the aeration tank without disassembling the air line. These are referred to as swing headers. If they do not have swivel joints, they are sometimes referred to as fixed headers. The fixed headers may also be located on the side of the aerated tank wall or in another location, such as on a rotating arm.

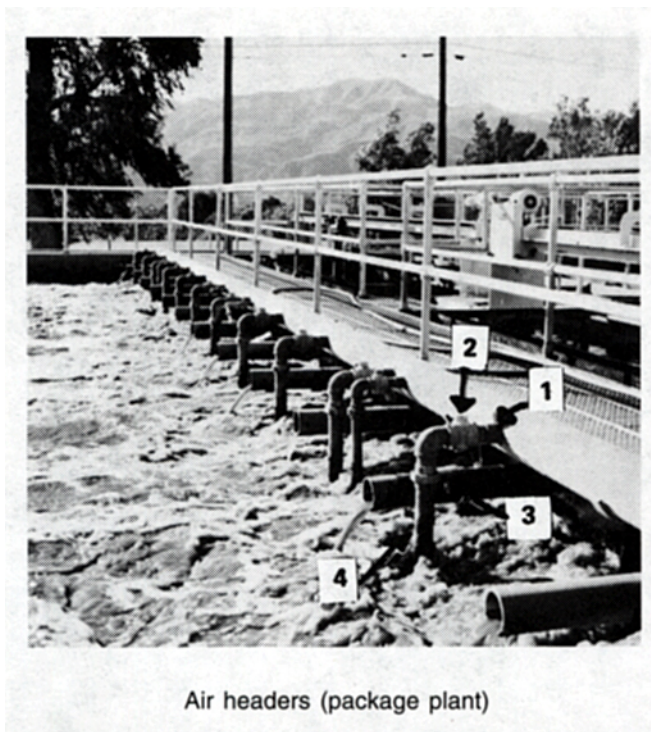

Air headers (package plant)



Figure 2.7 Fixed Header<sup>7</sup>



Valves are used to isolate blowers, headers, or other areas of the air piping based on system performance requirements or to perform maintenance. Valves may also be used to balance the air flow between several air lines or to throttle centrifugal blowers. Throttling a blower creates a pressure drop that changes the output of the blower. This would be done to reduce the aeration capacity of the system, if required.

Metering devices are used to assist in balancing the air distribution between several air lines, or to measure the air flow from a blower or through a particular pipe. An orifice plate with up stream and downstream pressure gauges is a commonly-used metering device for air piping.

### Diffusers

Diffusers distribute air into the aeration tank to dissolve oxygen into the wastewater and to enhance mixing. Three general classifications of diffusers are in common use.

- Fine bubble diffusers
- Medium bubble diffusers
- Coarse bubble diffusers

As the names suggest, the differences between the classifications is related to the size of the air bubbles they produce.

#### *Fine Bubble Diffusers*

Fine bubble diffusers are available in a range of designs including plates, tubes, and domes. Ceramic is a common material of construction for fine bubble dome diffusers.

- The principle benefit of fine bubble diffusers is the relatively high oxygen transfer efficiency compared to other types of diffusers. Fine bubble diffusers have a nominal oxygen transfer efficiency of approximately 6-15%.
- Disadvantages of fine bubble diffusers include:
  - Their susceptibility to becoming clogged due to dirty air (on the inside) or biological growth on the outside.
  - Their limited air handling capacity compared to other types of diffusers.
  - Relatively greater capital cost compared to other types of diffusers.

### *Medium Bubble Diffusers*

Medium bubble diffusers strike a balance between cost and performance. Medium bubble diffusers have an oxygen transfer efficiency between that of fine and coarse bubble diffusers, approximately 5-12%. Maintenance requirements are less rigorous than for fine bubble diffusers; however, care must be taken to minimize the impact from dirt and dust in the pressurized air.

A common medium bubble diffuser design employs a synthetic (i.e., nylon or dacron) sock clamped to a plastic diffusion tube. The synthetic sock material further diffuses the coarse bubbles released by the plastic tube, somewhat enhancing the oxygen transfer by reducing the size of the bubbles released by the diffuser.

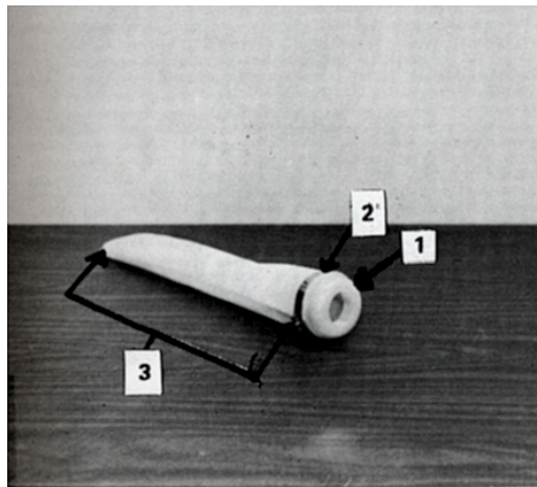

Nylon sock

1. sock to support frame and threaded header mount
2. sock to support frame clamp
3. porous sock (air comes out between ends indicated by arrows)

Figure 2.8 Medium Bubble Diffuser<sup>8</sup>

### *Coarse Bubble Diffusers*

Coarse bubble diffusers are available in the widest range of designs. To keep the cost down, coarse bubble diffusers are commonly made of plastic.

- The benefits of coarse bubble diffusers are:
  - Relatively low cost.
  - Greater air handling capacity compared to other types of diffusers.
  - Less maintenance concerns compared to other types of diffusers.
- The principal disadvantage of coarse bubble diffusers is the relatively low nominal oxygen transfer efficiency of approximately 4-8%.

## Safety Procedures

Practice the **ABC** of Safety, **A**lways **B**e **C**areful.

Always perform proper lock out / tag out procedures when dealing with electrical and mechanical systems and follow confined space entry procedures (air monitoring, safety equipment, etc.).

### Aeration Tanks and Clarifiers

Many conditions around an aeration tank can contribute to slips and falls.

- Avoid Slips and falls by minimizing or eliminating the following conditions:
  - Algal growth on walkways.
  - Spilled oil and grease.
  - Tripping hazard due to tools, equipment, and materials lying about.
  - Icy conditions.
- Do not remove guardrails unless absolutely necessary.
- Remember that the air in an aeration tank reduces the buoyancy effect of water, so it is much more difficult to stay afloat in an aerated tank than in a tank of water.
- Wear flotation device
  - When working over an aeration tank, wear an approved flotation device and/or fall arrest system as appropriate.
- Wear fall arrest system
  - When working at high elevations over an aeration tank, wear an approved fall arrest system.

### Mechanical (Surface) Aerators

Electrical safety and falls are a concern around or near surface aerators. Before performing electrical repair, shut off the main power and use lock out / tag out procedures.

### Air Filters

Prior to performing any maintenance on air filters, turn off blowers and use lock out / tag out procedures.

- Wear gloves and safety glasses to keep foreign matter out of eyes.
- Wear an approved dust and mist respirator to prevent ingestion or inhalation of filter dust.

### **Blowers**

Before starting blowers, open inlet and discharge valves, check system for foreign material and remove if found and use lock out / tag out procedures.

- Wear hearing protection
  - Limit noise exposure.
  - Be clear of blower before starting.

### **Air Distribution System**

Areas near aeration tanks where piping is located can be hazardous. The aeration tank could be full of wastewater or empty.

- Wear flotation device or fall arrest system.
  - Use appropriate safety equipment.
  - Work in pairs.

### **Air Headers and Diffusers**

Air headers and diffusers are located in aeration tanks, which can be a hazardous area.

- Wear safety equipment and work in pairs.
- Follow confined space entry procedures.
- If using a hoist to remove headers:
  - Check to see if the hoist is properly anchored before lifting.
  - Remove locking pin on swing joint.
  - Be familiar with hoist controls.

**Safety Case Study**

You are an operator at a wastewater facility where you will be changing the diffusers in an aeration tank. The aeration lines are equipped with swivel joints, so you can keep the tank in service during the change out. There was a rain shower an hour before the scheduled change out. Please identify safety concerns associated with this operation and how you would address the concerns to make the operation safer.

Concern	Possible Solution
Slips, trips, and falls	
Drowning	
Overhead falling hazards	
Pressurized line	



### Key Points for Unit 2 - Aeration

- Aeration dissolves oxygen into the wastewater in the aeration tank and helps to mix together the mixed liquor suspended solids and the incoming wastewater.
- Aeration is done by using mechanical or diffuser methods.
- Air filters are used to provide clean air to diffusers so that they do not become clogged.
- Blowers (compressors) are used to provide sufficient air pressure to operate the diffuser equipment.
- Air piping systems are used to transport the air from the blowers to the diffusers.
- Diffusers are classified according to the size of air bubbles that they produce and are called fine, medium, and coarse.
- Fine diffusers provide the best efficiency for dissolving oxygen, but they have the greatest tendency to clog.
- Standard safety procedures should always be followed in any work situation including lock out / tag out and use of safety equipment.



Exercise for Unit 2 - Aeration

1. What are the purposes of aeration?

---

---

---

---

2. What is the difference between mechanical and diffused aeration?

---

---

---

---

3. What are the precautions that must be taken before one attempts to maintain or repair a surface aerator?

---

—

---

---

---

4. What are some of the hazards that could be found when working on air headers?

---

---

---

---

<sup>1</sup>Figure 2.1 Mechanical aeration device [Figure 11.3, p. 24, from *Operation of Wastewater Treatment Plants, Volume II*, 5<sup>th</sup> Edition (Sacramento)]

<sup>2</sup>Figure 2.2 Fine Bubble Air Diffuser [Figure 11.4, p. 25, from *Operation of Wastewater Treatment Plants, Volume II*, 5<sup>th</sup> Edition (Sacramento)]

<sup>3</sup>Figure. 2.3, Rotary Positive Displacement Blower [Figure 11.8, p. 30, from *Operation of Wastewater Treatment Plants, Volume II*, 5<sup>th</sup> Edition (Sacramento)]

<sup>4</sup>Figure. 2.4, Centrifugal Blower [Figure 11.10, p. 32, from *Operation of Wastewater Treatment Plants, Volume II*, 5<sup>th</sup> Edition (Sacramento)]

<sup>5</sup>Figure. 2.5, Air Distribution Piping [Figure 11.11, from *Operation of Wastewater Treatment Plants, Volume II*, 5<sup>th</sup> Edition (Sacramento)]

<sup>6</sup>Figure. 2.6, Swing Header [Figure 11.12, p. 35, Swing Header (lower left) from *Operation of Wastewater Treatment Plants, Volume II*, 5<sup>th</sup> Edition (Sacramento)]

<sup>7</sup>Figure. 2.7, Fixed Header [Figure 11.13, p. 36, Air headers (package plant), (upper left), from *Operation of Wastewater Treatment Plants, Volume II*, 5<sup>th</sup> Edition (Sacramento)]

<sup>8</sup>Figure. 2.8, Medium Bubble Diffuser [Figure 11.14, p. 37, Nylon Sock (upper left), from *Operation of Wastewater Treatment Plants, Volume II*, 5<sup>th</sup> Edition (Sacramento)]



## **Unit 3 – New Plant Start-up Procedures**

---

---

### **Learning Objectives**

- Explain the purpose of plant and equipment review prior to plant start-up.
- List equipment and structures that need to be checked.
- Explain the plant start-up procedure.

### Document Familiarization

A thorough review of plant documents will help the operator with equipment understanding and startup.

#### Review Operation and Maintenance Manual

A whole plant operation and maintenance (O&M) manual is usually provided.

- Review the manual in total and ask questions of the appropriate person.

#### Review Each Manufacturer's Manual for Equipment

Each major piece of equipment should have a maintenance manual available.

- Review maintenance manuals prior to checking and starting equipment.
- Review the recommended maintenance procedures.
- Review the recommended spare parts inventory.

#### Review Record Plans

Record Plans will summarize the as-constructed information on the plant.

- Study the record plans with particular attention to the process flow path and the location of piping and valves.
- Consider various operational scenarios while reviewing the plans. For instance, how to operate the plant while taking a duplicate piece of equipment off line for maintenance and keeping the plant operating.

### Equipment Familiarization

A thorough review of the constructed facilities will help in the startup and later efficient operation.

#### Review Equipment and Piping Locations

- Field review the plant construction after the record plan review.
- Spend time with each manufacturer's representative during startup of equipment.
- Ask questions and learn how the equipment functions and what maintenance is required.
- Learn what each piece of equipment does and how it is supposed to work.

#### Check for Proper Functioning of Equipment Prior to Being Put into Service

Attention now to proper equipment functioning will make startup and operation easier.

- Proper operation is important to the equipment warranty.
- Inspect each piece of equipment with the maintenance manual in hand.



If your waste treatment plant were missing a particular manufacturer's manual, how would you go about obtaining one?

---

---

---

---

## Flow Control Gates and Valves

Check all flow control gates and valves. Improperly operating gates and valves can create significant operation problems.

### Check Valves for Seal and Function

Valves should operate smoothly while opening and closing.

- Valves should have a positive seal.
- Find any improperly operating valves and repair prior to filling the plant.

### Record Data: Valve Positions, Turns, Opening Direction

Having historical data on valves and gates will be valuable information for future maintenance and to future operators.

- The data will reflect the new and proper operating condition.
- This data will assist in future maintenance.

### Touch Up Protective Paint Coating and Lubricate Valves

Repairing nicks and scratches in coatings will prolong tank life.

- Lubricate valves while easily accessible.

## Piping and Channels

### Inspect Piping and Channels

Check for and Remove Any Debris.

- Debris left in a pipe can cause a significant problem later on.
- Debris, if not removed, can jam a valve or gate or can render one inoperable.
- Debris can pass through the process and get into a pump and create a blockage.

### Repair Protective Coatings as Necessary

Damage to protective coatings in a wastewater atmosphere will quickly deteriorate the coating and the material protected.

- Repairs made prior to filling of the plant and beginning operation will be easier and longer lasting.

### Weirs

Weirs are used for both flow management and flow measurement of effluent from various treatment units and of the final effluent discharge.

Weir maintenance can have a significant impact on the proper operation of plant components and plant effluent compliance.

### Check Level of Weirs and Adjust if Necessary

Weirs out of level can cause an imbalance of flows in or out of plant components.

- Weirs used for flow splitting, if out of adjustment, can cause a hydraulic overload to an aeration tank along with an organic overload. This condition could move the F/M ratio out of the desired operating range.
- Outflow weirs on a secondary clarifier, if out of level, can cause a localized hydraulic flow path that can cause a short circuit through the clarifier. This condition can exceed the design parameters and put more total suspended solids into the effluent thereby causing an effluent problem.

### Touch Up Protective Paint Coating if Applicable

Depending upon the material used for the weir or with it in the clarifier, make repairs to the protective coatings as appropriate.



Why should an effluent weir be level?

---

---

---

---

## Froth Control System

The froth control system consists of a water spray that is applied to the surface of the activated sludge in the aeration tank.

Check the overall operation of the froth spray system prior to filling the aeration tanks because this piping is usually located over the aeration tank and will be more difficult and dangerous to check when the aeration tank is full.

### Check Nozzles

Inspect nozzle operation under pressure.

- Do the nozzles form overlapping fans of water?
- Are the fans approximately 45 degrees from the horizontal?
- Do the fans cover the desired area, if not, adjust as necessary?
- Make sure the spray is contained in the aeration tank and does not spray or drift onto handrails or walkways.

### Check Piping For Leaks

While inspecting nozzles under operation, check the remaining piping for leaks.

- Make repairs as necessary.
- Flush the system.

## Air System

The air system consists of filters, blowers, headers, and diffusers.

### Check Filters for Tight Seal and Foreign Objects

The filter's job is to remove dust and dirt from the air before it goes through the blower and to the aeration tank.

- Dirt and debris could damage the blower and clog the diffusers.

### Check System Pressure with a Manometer or Gauges

A Manometer, an instrument for measuring pressure, can be used to check the filter efficiency.

- Clean filters will have little pressure differential.
- Dirty filters will have more pressure differential.

### Check Piping for Debris

Clean piping is critical to the air system.

- Check the inlet piping to the blower for leaks and proper installation also.

### Check Blowers

Prepare a startup checklist.

- Prior to operating, check switches, lubrication, and coupling alignment.
- Check inlet and discharge valves prior to starting.
- Run blowers, check for overheating, vibrations, and take amperage readings, air flow rates, and differential pressures. Record all readings.
- Start the blower under no load, discharge goes to atmosphere.
- Slowly close valves and load the unit to the operating condition.

### Check All Air Headers for Leaks

Headers move the air from the air mains to the diffusers.

- Air leaks waste energy and may affect the dissolved oxygen level in the aeration tank.

### Check Diffusers

Proper diffuser operation is important in maintaining proper dissolved oxygen levels and mixing.

- Make sure the diffusers are attached properly and there are no misaligned connections or leaks. Air discharging anywhere but through the diffuser will be inefficient and cause poor system performance.
- Make sure the diffusers are clean and in good condition. Clogged diffusers can impact microorganism activity and negatively impact the process efficiency.



How is air cleaned before it is compressed and sent to the aeration tank?

---

---

- Make sure diffusers are installed at the same elevation. Unevenly installed diffuser headers will create an uneven distribution of air; the high diffusers will discharge too much air and the low diffuser too little. Unless all diffusers are at the same elevation, the water pressure will differ causing the uneven air distribution.



## Secondary Clarifier

A secondary clarifier performs an important function, the removal of solids from the plant effluent. The proper operation of a secondary clarifier impacts the plant effluent quality as well as the process operation of the aeration tank.

### Check Control Gate Operation

Check control gate operation, check for and remove debris, check drive mechanism, clearances, pipes and channels, baffles and weirs for level, and scum control mechanism. The ability of a secondary clarifier to handle solids and plant effluent depends on the proper operation of its many components.

- Clogged piping or improperly operating scrapers can cause problems in solids handling.
- Out of level overflow weirs can cause clarifier short circuiting and localized hydraulic loading rates in excess of design parameters.

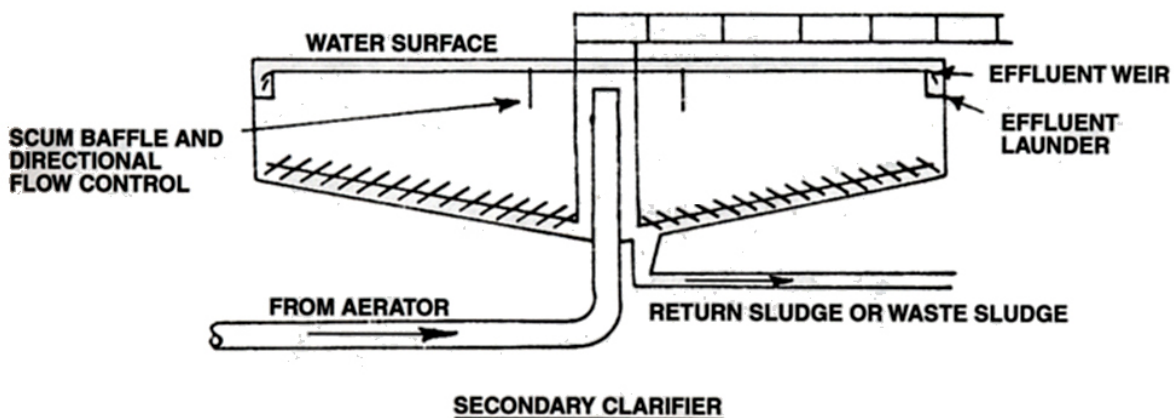

Figure 3.1 Secondary Clarifier<sup>1</sup>

### Return and Waste Sludge Pumps

Lock out and tag out the motor at the main electrical panel before performing any maintenance on sludge pumps.

- Before operation, check piping and impellor for debris, lubrication, coupling alignment, packing, and ease of rotation.
- Fill the system by putting water into the secondary clarifier sludge hopper.
- Check valves and check valves for leakage, open valves prior to a pump test run.
- Run a brief pump operating test.
- Check gauges and record all measurements.

## Process Units

Process units follow a methodical startup procedure by putting one process unit on line at a time and checking the operation of all related components.

### Aeration Tank

Starting the biological process in the aeration tank is the most important task for this unit. Start air blowers before filling aeration tanks, seed with activated sludge from another tank if needed, fill to overflow to secondary clarifier.

- When using seed sludge, try to get freshly wasted activated sludge. The sludge can be from the treatment plant where the unit is coming online or from another activated sludge plant. If sludge from another plant is used, the sludge should be healthy and the plant should be operating properly.
- It will take time to achieve a stable MLSS.
- Monitor dissolved oxygen levels in the aeration tank and adjust the air supply to maintain desired DO levels.

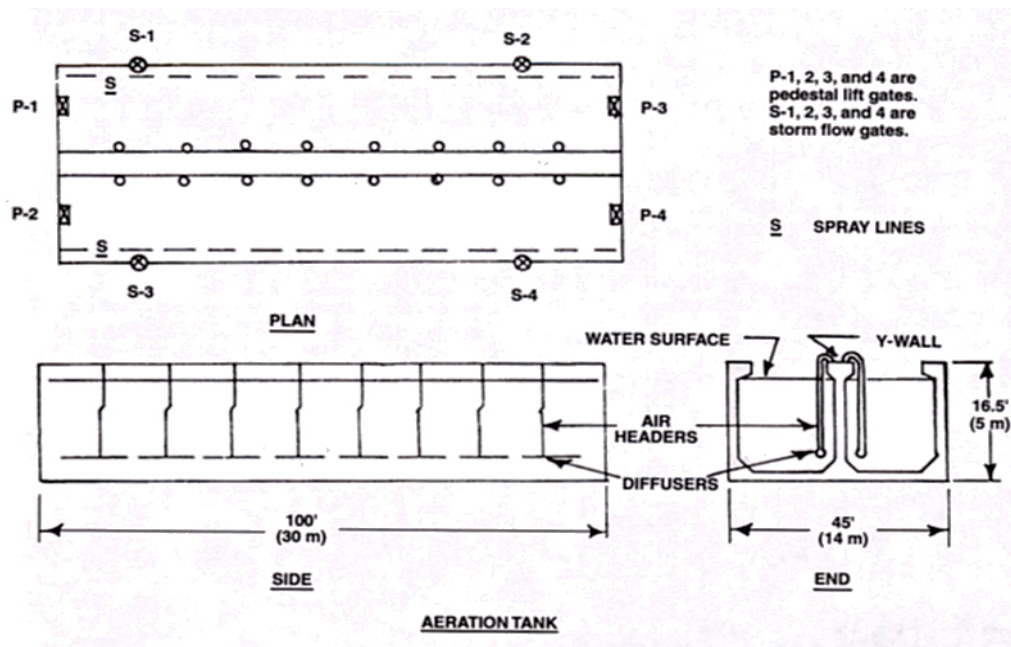

Figure 3.2 Aeration tank (Side, Plan, and End views)<sup>2</sup>

### Secondary Clarifier

Fill all clarifiers, start collector mechanism and return sludge pumps at  $\frac{3}{4}$  full. Try to keep sludge retention time in the clarifier to less than  $1 \frac{1}{2}$  hours.

- Manage the RAS rate to begin to build a solids inventory in the aeration tank and a sludge blanket in the clarifier.

### Disinfection System

Start the disinfection system when the secondary clarifier is full and overflowing into the disinfection tank. Adjust the disinfection system, and if chlorination is used, vary the feed rate to control the chlorine residual.

- Check the manufacturer's literature and O & M manual for any adjustments needed for other forms of disinfection.

### Froth Spray System

Use as needed. The initial startup of the aeration tank may create substantial foaming.

- Operate the froth spray system as required.
- If the froth spray is not available, consider using a commercial defoamer in the aeration tank.



Blowers should be started prior to admitting primary effluent to the aeration tank. Why?

---

---

---

---

## Process Control

Monitoring of and making adjustments to various parameters is an important part of process control associated with the operation of an activated sludge plant.

### Air System and Dissolved Oxygen (DO) Levels

Monitor DO levels in aeration tank periodically, adjust air to suit DO levels and tank mixing. During the initial plant startup, DO levels may be high because of the low number of organisms initially present.

- As the microorganism population increases, to maintain a target dissolved oxygen range, increase the air supply.

### Rapidly Return Clarifier Solids

Rapidly return clarifier solids to aeration during initial startup and monitor sludge return rates thereafter. During a plant startup, due to the low number of organisms in the aeration tank, the RAS rate from the clarifier would be a higher return percentage due to the thinner sludge.

- As the process matures and the solids inventory in the aeration tank increases, the return rate of a thicker sludge would be less.

### Testing

Take 30-minute settleability tests on activated sludge in aeration tanks. Begin process calculations as activated sludge process comes on line to monitor MLSS levels, F/M ratio, etc. Periodic testing, not only during plant startup but during normal operation, is a key component to operating an efficient plant.

- Performing process calculations periodically will assist the operator in understanding the health of the plant, provide a base line for comparison when changes occur, and assist in the development of a method and timing of various operations.



### Key Points for Unit 3 – New Plant Start-up Procedures

- Before starting a new plant the operators should do a thorough review of all plant documents including:
  - the plant operation and maintenance (O&M) manual
  - each manufacturers manual for equipment
  - the plant record plans
- Become familiar with all equipment and piping locations.
- Make sure that each piece of equipment is functioning properly before putting it into service.
- During start-up it is important to rapidly return clarifier solids to the aeration tank to make sure there are enough microorganisms in the aeration tank to achieve stable operation.
- Remember that the plant O&M manual and experienced operators are valuable resources for you to use during and after plant start-up.



Exercise for Unit 3 – New Plant Start-up

1. Why must all of the horizontal pipes containing the air diffusers be at the same elevation (level)?

---

---

---

---

2. Why should an operator completely check the equipment and structures before startup?

---

---

---

---

3. The \_\_\_\_\_ manual, if available, should contain a wealth of information concerning how to run the plant.

4. \_\_\_\_\_ plans will summarize the as-constructed information about the plant.

5. Out of level weirs can cause an imbalance of flows in the plant and potentially cause problems with the plant effluent.

- a. True            b. False

<sup>1</sup> Figure 3.1 Secondary Clarifier (Adapted from Figure 11.17, p. 43, from Operation of Wastewater Treatment Plants, Volume 11, 5<sup>th</sup> Edition (Sacramento))

<sup>2</sup> Figure 3.2 Aeration tank (Side, Plan, and End views from Figure 11.17, p. 43, from Operation of Wastewater Treatment Plants, Volume II, 5<sup>th</sup> Edition (Sacramento))