

Project No. 85-154
March 1987

 Paul C. Rizzo Associates, Inc.
CONSULTANTS



Report

Revised Remedial Action Plan Westinghouse Plant, Area A-9

Beaver, Pennsylvania

Westinghouse Electric Corporation
Beaver, Pennsylvania

WPL 005 5527

SET 0020566

REVISED
REMEDIAL ACTION PLAN
WESTINGHOUSE PLANT, AREA A-9
BEAVER, PENNSYLVANIA

MARCH 12, 1987
PROJECT No. 85-154

PAUL C. RIZZO ASSOCIATES, INC.
10 DUFF ROAD, SUITE 300
PITTSBURGH, PENNSYLVANIA 15235
PHONE: (412) 242-7900
TELEX: 882225 RIZZO ASSOC

WPL 005 5528

DCR

SET 0020567

TABLE OF CONTENTS

	<u>PAGE</u>
1.0 INTRODUCTION	1-1
2.0 PLAN FOR FASTER CONTAMINANT REMOVAL	2-1
3.0 REVISED SCOPE OF REMEDIAL ACTIVITY	3-1
3.1 ADDITIONAL SITE INVESTIGATION	3-1
3.2 INSTALLATION OF NEW SHALLOW MONITOR WELLS	3-2
3.3 INSTALLATION OF NEW MONITOR WELLS IN THE DEEP AQUIFER	3-2
3.4 SEALING OF WELL B-8	3-3
3.5 INSTALLATION OF GROUNDWATER CUT-OFF TRENCHES	3-4
3.6 RECLAMATION OF STORAGE TANK AREA	3-5
3.7 CAPPING OF AREA A-9	3-5
3.8 MONITORING AND DATA REPORTING	3-5
4.0 WORK PROCEDURES	4-1
4.1 DRILLING TO DEFINE CONTAMINATED PERCHED WATER ZONES	4-1
4.1.1 Spot Test for pH	4-1
4.1.2 Spot Test for Cyanide	4-1
4.2 DRILLING AND SHALLOW MONITOR WELL INSTALLATION	4-2
4.3 DRILLING AND DEEP MONITOR WELL INSTALLATION	4-2
4.4 SEALING OF WELL B-8	4-3
4.5 CONSTRUCTION OF CUT-OFF TRENCHES	4-3
4.6 ASPHALT CAP PLACEMENT	4-5
4.7 PUMPING FROM CUT-OFF TRENCHES	4-5
4.8 DECONTAMINATION AND WASTE DISPOSAL/TREATMENT	4-5
4.9 SAMPLING AND LABORATORY TESTING	4-6
4.10 HEALTH AND SAFETY PROGRAM	4-9
5.0 SUMMARY	5-1

REFERENCES

TABLES

FIGURES

APPENDIX A: RECENT DATA FROM AREA A-9

WPL 005 5529



SET 0020568

**REVISED
REMEDIAL ACTION PLAN
WESTINGHOUSE PLANT, AREA A-9
BEAVER, PENNSYLVANIA**

1.0 INTRODUCTION

This report is a revised version of the original Remedial Action Plan for Area A-9 at the Westinghouse Beaver Plant (Figures 1 and 2) which was submitted by Paul C. Rizzo Associates, Inc. (Rizzo Associates) in July 1986. As in the original Plan, the aim of this Plan is containment and removal of the acidic and basic solutions in the shallow subsurface at Area A-9. These groundwaters are contaminated with silver and cyanide.

The original Remedial Action Plan called for continuous pumping from the existing wells and treatment of the extracted water at the plant's waste water treatment facility. In addition, two new monitor wells were proposed to track contaminant concentrations in the perched zone. The goal of this plan was to mitigate the potential for off-site transport of contaminants, especially the high pH groundwater containing cyanide. Continuous pumping at the site commenced in June 1986 and the results to date are promising (see Appendix A).

The Plan described above was submitted to the Pennsylvania Department of Environmental Resources (PADER) for approval as part of the Closure Plan for Area A-9. PADER responded to the Plan in an October 9, 1986 letter to Ms. Sherry Graham of Westinghouse. In that letter, Mr. John A. Haluszczak, Hazardous Waste Coordinator of the Southwestern Regional Office of PADER, stated that the Plan must be amended in the following ways before it can be approved:

- The Plan must provide for faster removal of contaminants, particularly the silver and cyanide present.
- At least two additional monitor wells must be installed in the deep aquifer to:
 - define the groundwater quality,
 - identify any possible contamination, and
 - establish the hydraulic gradient.
- The Plan must include a description of how the excavated area in the location of the former waste storage tanks will be reclaimed.

The original Remedial Action Plan has been extended and all of the suggested changes have been incorporated in the Plan. As requested by PADER, this revised Plan includes provisions for faster removal of silver and cyanide, additional monitoring wells, and for reclamation of the former waste storage tank area.

Additions to the original Plan focus on speeding the removal of the contaminated groundwater at the site. To this end, it is proposed that cut-off trenches be constructed to speed up collection of the perched, near-surface groundwater found to contain cyanide and silver. The rationale for choosing groundwater collection via cut-off trenches is presented in Section 2.0. After discussion of the proposed approach for speeding contaminant removal, the revised Remedial Plan is described in detail (Section 3.0), as are the work procedures that will be needed to implement the Plan (Section 4.0).

2.0 PLAN FOR FASTER CONTAMINANT REMOVAL

The proposed method for speeding the removal of contaminants is to excavate trenches near the boundaries of Area A-9, fill them with gravel, and use them as groundwater collection devices by pumping them out regularly. This will enable more rapid removal of contaminants and will provide a barrier to the off-site migration of contaminated groundwater. [Contaminated groundwater is currently being withdrawn from the perched zones with the existing wells in place at Area A-9.] Other advantages of the cut-off trench approach are that no additional liquid is injected to the perched water system as would occur in any flushing scheme, and also the low pH and high pH groundwaters can be collected separately.

Geochemical conditions at the site make it probable that the analytes of concern are largely in the groundwater and thus potentially recoverable with the proposed cut-off trench scheme. At low pH values, metals do not adsorb onto soils (e.g., Jenne, 1977) or precipitate, so silver should be dissolved and available for recovery in the low pH zone of contamination. Only low levels of cyanide are present in this zone because hydrogen cyanide (HCN), the dominant form of cyanide at low pH, volatilizes rapidly. At high pH values, cyanide exists predominantly as the anionic species CN^- . Because anions such as CN^- tend to desorb from soil materials at high pH (e.g., Hingston et al., 1972; Ryden et al., 1977), and because CN^- tends to keep silver in solution via the formation of strong complexes (e.g., Morel, 1983), the cyanide and silver in the high pH zone of contamination should be in the groundwater and hence available for recovery.

3.0 REVISED SCOPE OF REMEDIAL ACTIVITY

The goals of the proposed remediation are

- to mitigate the potential for off-site transport of contaminated groundwater
- to rapidly remove and treat as much of the contaminated groundwater as possible.
- to cap the site and thus prevent the generation of additional contaminated groundwater.

Of various alternatives considered for accomplishing the first two objectives, an approach based on the excavation of groundwater cut-off trenches appears to be the most viable, as discussed in Section 2.0. A cut-off trench scheme for interception and collection of contaminated groundwater in the shallow subsurface at Area A-9 is the core of the revised Plan. A number of other important issues are also addressed in the Plan, however, including additional monitoring of the shallow perched zones, additional monitoring of the deep aquifer, reclamation of the former storage tank area, and elimination of recharge to the shallow subsurface. Details of the various tasks in the revised Remedial Plan are presented below.

3.1 ADDITIONAL SITE INVESTIGATION

To decide exactly where the cut-off trenches will be placed, some additional site characterization is needed. Five to ten shallow auger borings are proposed to better define the thickness and extent of the perched water bearing zone(s) near the surface. Field tests for pH and cyanide will be performed on a number of soil samples obtained by split-barrel sampling in the course of this exploratory boring program. These borings will not be cased and will be grouted upon completion. Their locations will be determined in the field.

3.2 INSTALLATION OF NEW SHALLOW MONITOR WELLS

For the purpose of monitoring changes in groundwater levels and groundwater quality in the perched zones near the fringe of the high pH contamination, three new shallow monitor wells are proposed for Area A-9. Two of the wells, B-9 and B-10, will be located near the plant boundary (chain link fence) on the south side of Area A-9. The third well, B-11, will be placed farther to the southwest. Recent data seem to indicate that the high pH contamination plume has moved parallel to the property boundary in a southwesterly direction from Well B-1B to Well B-7 (see Appendix A). If this is indeed the case, it will be useful to monitor the southwest extension of the plume. The exact locations of the new shallow monitor wells will be determined after results from the exploratory borings are evaluated. Details of the sampling program to be conducted at all the shallow monitor wells are given in Section 3.8.

3.3 INSTALLATION OF NEW MONITOR WELLS IN THE DEEP AQUIFER

The PADER has requested that two additional monitor wells be drilled to the deep aquifer to define and monitor the groundwater quality and to establish the hydraulic gradient. Accordingly, two deep monitor wells are proposed at the locations indicated on Figure 2 (Wells B-12 and B-13). The rationale underlying the selection of these locations is discussed below.

Hydrogeologic data from the one deep well that has been drilled in Area A-9 (Well B-5) and from several plant foundation borings (Baker, 1967) indicate that the deep aquifer is phreatic and uniformly thin under the plant. The available data are presented in Table 1; the locations of the various borings are shown on Figure 2. As indicated in Table 1, the deep aquifer is apparently 1.5 to 2 feet thick under the Breaker Assembly Building and also under Area A-9, and the bedrock slopes NW-SE toward the Ohio River with a gradient of approximately 0.08. The relatively thin saturated thickness of the aquifer under the plant is consistent with the fact that the plant is located at the edge of an alluvial terrace where bedrock elevations are slightly higher than the

pool elevation of the main alluvial aquifer. The deep aquifer under the plant is not yet part of the alluvial pool or the saturated thickness would be greater.

To define the gradient in the deep aquifer more accurately, two additional deep wells will be placed as indicated on Figure 2. One well (B-12) will be located just west of the existing deep well, B-5, while the other well (B-13) will be drilled on the opposite (north) side of the plant. With the installation of these two additional wells, there will be three wells in the deep aquifer and a more accurate determination of the gradient toward the Ohio River will be possible.

Chemical data from Well B-5 indicate that water in the deep aquifer meets drinking water standards. Since any leakage of contaminated groundwater from the perched zone in Area A-9 would in all likelihood descend vertically (unsaturated flow) to the vicinity of Well B-5, it appears that the deep aquifer has not been impacted from the near-surface contamination. To verify this, water samples will be drawn bi-monthly from the two deep wells located in Area A-9 (Wells B-5 and B-12). This sampling will be conducted for at least the first six months after initiation of remedial activities. Note that Well B-12 will be placed near the projected leading edge of the existing plume which apparently is moving to the southwest in the shallow water bearing zone. Details on the deep aquifer monitoring program are provided in Section 3.8.

3.4 SEALING OF WELL B-8

Well B-8 (see Figure 3) is the only monitor well installed that has significant penetration into the natural alluvium underlying the surficial fill at Area A-9. The well proved to be dry (Rizzo Associates, 1986a) and should be closed. Well B-8 will be sealed with a cement-bentonite mix, as described in Section 4.4.

SET 0020574

3.5 INSTALLATION OF GROUNDWATER CUT-OFF TRENCHES

It is proposed that two cut-off trenches be excavated in Area A-9, one to collect the low pH groundwater (Trench 1) and the other to collect the high pH groundwater (Trench 2). Tentative dimensions and locations for these trenches are indicated on Figure 3, but the exact locations will not be established until the additional site investigation work is completed. Moreover, the extent and depth of each trench will be determined in the field. Trench 1 will be excavated adjacent to Well B-4 and will essentially encompass the area formerly occupied by the waste storage tanks. It will be used to collect the low pH, metal-containing groundwater in the vicinity of Well B-4. The soils that will be removed in the excavation of Trench 1 are potentially contaminated (Rizzo Associates, 1985) and will be disposed in a RCRA facility if necessary.

As Trench 1 is excavated, a careful search will be made for a possible source of the low pH water. The volume of water pumped from Well B-4 is always much greater than the volume obtained from any of the other wells which, together with the markedly different chemical characteristics of the water, raises the question of an unknown source of low pH water near Well B-4 (Rizzo Associates, 1986a).

The L-shaped Trench 2 will serve to collect the high pH groundwater contaminated with silver and cyanide. From the history of cyanide contamination in the various monitoring wells (see Appendix A), the high pH plume appears to be moving slowly to the southwest approximately parallel to the plant. As shown on Figure 3, one side of Trench 2 will be located to intercept this southwesterly migration and the other side will be located along the property boundary to prevent any migration off the site should the plume move southward.

Both cut-off trenches will be excavated so as to not pierce the sand layers beneath the surficial fill. The depths are anticipated to be 10 to 15 feet, but the exact depths will be determined in the field. The

bottoms of both trenches will be sloped to one end and covered with a chemical-resistant synthetic liner. Slotted PVC pipe will be placed in the "sump" at the bottom of each trench, and collected groundwater will be conveyed to the plant waste water treatment system by pumping. The trench design details are discussed in Section 4.5.

3.6 RECLAMATION OF STORAGE TANK AREA

The area formerly occupied by the waste storage tanks is now a shallow pit. Excavation for Trench 1 will begin in this pit which will be deepened and possibly extended. Material from the excavation will be treated as potentially contaminated. If required, this material will be disposed in a RCRA facility. Upon completion of the excavation, Trench 1 will be filled almost to the surface with gravel and capped with a compacted soil layer. The ground surface will be graded to prevent ponding in the vicinity of the reclaimed tank area, and will then be covered with an asphalt cap.

3.7 CAPPING OF AREA A-9

After the groundwater cut-off trenches have been constructed and the new monitor wells have been installed, all of Area A-9 will be covered with an asphalt cap. This cap will serve to reduce substantially or eliminate recharge to the perched groundwater zones in the shallow subsurface at Area A-9. Pumping data from the existing wells at Area A-9 seem to indicate that the shallow perched zones are being recharged following rainfall events (see Appendix A).

3.8 MONITORING AND DATA REPORTING

The effectiveness of the proposed remediation scheme will be evaluated on the basis of data obtained in a planned monitoring program. Water levels in the shallow monitor wells will be checked and samples will be withdrawn for pH analysis at the start of the remedial program and weekly thereafter. Water samples from the shallow monitor wells and from the collection trenches will be taken and analyzed for pH, cyanide,

SET 0020576

silver, sulfate, nitrate, and chloride at the beginning and then monthly. Samples from the monitor wells in the deep aquifer will be collected bi-monthly and analyzed for the same parameters.

Monitoring data will be examined closely as it is gathered to assess the effectiveness of the cut-off trenches in capturing the perched, contaminated groundwater and the effectiveness of the asphalt cap in reducing recharge. It is anticipated that decreasing amounts of groundwater will be extracted with time and that the contaminant concentrations will also decrease.

After the cut-off trench system has been in operation for six months, a report will be prepared which summarizes the data obtained and presents conclusions on the effectiveness of the Remedial Plan. At this time a decision will be made as to the need for additional monitoring.



4.0 WORK PROCEDURES

In this section the work procedures needed to implement the expanded Remedial Plan are described in detail. The applicable work procedures include exploratory drilling; monitor well installation in the shallow subsurface and in the deep aquifer; closure of Well B-8; construction of groundwater cut-off trenches; placement of an asphalt cap; decontamination and waste disposal/treatment; pumping and treatment of groundwater collected in the cut-off trenches; sampling and laboratory testing; and implementation of a health and safety program.

4.1 DRILLING TO DEFINE CONTAMINATED PERCHED WATER ZONES

A number of shallow auger borings will be made in Area A-9 to better define the perched water zones near the surface and the presence or absence of contamination. These borings will be performed with a 6.25-inch O.D. continuous-flight, hollow-stem auger. The presence of perched water will be determined by an experienced field geologist/engineer on the basis of visual observation. Split-barrel samples will be obtained every 2.5 feet and analyzed for pH and cyanide in the field. These data will be used to determine the exact locations and dimensions of the collection trenches. The exact number of borings required will be determined in the field but it is estimated that 5 to 10 will be needed.

4.1.1 Spot Test for pH

A 1:1 slurry (volume basis) will be prepared and checked with litmus paper to obtain the approximate pH of the soil sample.

4.1.2 Spot Test for Cyanide

If the litmus test of the 1:1 slurry indicates a neutral or basic solution, a check for the presence of cyanide will be made using the colorimetric Hach Cyanide Test.

4.2 DRILLING AND SHALLOW MONITOR WELL INSTALLATION

Drilling for the three new shallow monitor wells proposed for Area A-9. (Wells B-9, B10, and B-11) will be performed with a 6.25-inch diameter hollow-stem, continuous-flight auger. The drilling will be monitored closely by an experienced field geologist/engineer in order to identify zones containing perched water. For each well, drilling will be extended to a depth of 20 feet and soil samples will be taken at 2.5 foot intervals by split-barrel sampling. The split-barrel sampler will be decontaminated using the procedures described in Section 4.8. After being visually classified, soil samples will be stored in clean glass jars. These jars will then be placed on ice for shipment to the testing laboratory. The soil samples will be analyzed for pH, cyanide, silver, sulfate, nitrate, and chloride.

The wells will be constructed using 2-inch ID threaded flush joint PVC pipe with 0.010-inch mechanically slotted pipe placed adjacent to the wet zones encountered in the course of drilling. Sand will be packed to a point at least 1 foot above the slotted section. At that point, a 3-foot bentonite seal will be placed and the remainder of the annular space will be grouted to the surface. A steel protective casing with locking cap will be grouted in place at the surface; the stick-up height will be selected so that the well cap will be flush with the asphalt surface to be placed. The wells will be developed by alternately surging and pumping.

4.3 DRILLING AND DEEP MONITOR WELL INSTALLATION

The two additional deep wells, B-12 and B-13, will be drilled using hollow-stem auger techniques. Soil sampling will be conducted at 2.5 foot intervals for the first 20 feet and at 5-foot intervals thereafter. The wells will be constructed using 2-inch I.D. threaded flush joint PVC pipe, and mechanically slotted (0.010-inch) PVC pipe will be placed in the bottom of each deep well for approximately 10 feet above the bedrock. Protective casing and a locking cap will be installed at each wellhead.

4.4 SEALING OF WELL B-8

Well B-8, a dry well that penetrates the silty sand layers beneath the surficial fill at Area A-9, will be sealed to prevent the well from acting as a conduit for the downward migration of contaminated, near-surface groundwater. The sealing of this well will consist of pulling out the casing, drilling out the hole with an oversized bit, and grouting the hole with a cement-bentonite mix. If the casing cannot be pulled out, it will be drilled out with a hollow-stem auger.

4.5 CONSTRUCTION OF CUT-OFF TRENCHES

The two groundwater interception trenches will be located approximately as shown on Figure 1. The exact placement of the trenches will not be determined until the exploratory borings are performed and the results are analyzed. Every attempt will be made to locate Trench 2 in an uncontaminated area. Soils in Trench 1 are potentially contaminated and will be assessed for proper disposal requirements upon excavation.

The trenches will be excavated with a backhoe to the approximate dimensions given on Figures 4A through 4E. The exact dimensions of the trenches will be determined in the field by an experienced geologist/engineer who will evaluate subsurface conditions, especially the clay content of various layers and the presence of perched water, as excavation proceeds. To the extent possible, the trenches will be graded to obtain smooth side and bottom surfaces so that the composite geomembrane/geotextile liner to be placed subsequently will not bridge cavities in the soil or be damaged by projecting rock. Soils from the excavation of Trench 1 will be analyzed for the parameters listed in Table 4. If necessary, the excavated soil material will be transported to a licensed RCRA disposal facility.

Following excavation of the trenches, a geomembrane/geotextile liner will be placed in each trench by a qualified installer. The composite liner will consist of a flexible geomembrane sewn to nonwoven filter

fabric. As shown on Figures 4B, 4D and 4E, the geomembrane will be used as a protective barrier at the bottom of the trench to prevent the downward migration of contaminated groundwater. Overlaps (if any) of liner sheets along the geomembrane portion of the liner will be properly sealed; overlaps of the fabric will be secured with anchor pins.

The geomembrane and nonwoven geotextile to be used for the composite liner will meet the minimum standards specified in Table 2. Once the liner is in place, a four-inch diameter PVC pipe, mechanically slotted (0.020-inch) for the bottom 2.5 feet, will be placed vertically in each sump. Its position will be secured by careful backfilling with river gravel at the base and by use of a temporary support at the surface. Next, the trenches will be backfilled with 1.5 to 2 inch diameter river gravel to within two feet of the surface. At this point, the temporary pipe support will be removed, a protective six-inch diameter steel casing will be placed around the PVC pipe, the filter fabric will be folded over near the well, and a cylindrical concrete box with a manhole cover will be fitted around the well as shown on Figures 4A - 4E. This cylindrical box will have a 6-inch diameter hole in the bottom to accommodate the protective well casing, and a 6-inch diameter hole in the side (1 foot from the top) to accommodate the corrugated polyethylene pipe that will provide structural protection for the suction tubing from the well (see Figures 4A and 4C). Gravel will then be placed in the rest of the trench to within 6 inches of the surface, and the remainder of the filter fabric will be folded over so that gravel drain is completely enclosed. The trench will be backfilled to surface level by placing a layer of compacted soil on top of the drain. This soil layer will act as a seal to help prevent surface runoff from entering the drain prior to placement of the asphalt cap.

Tubing from the trench wells will be wrapped with electric heating cord, insulated, and routed through the corrugated polyethylene pipe to the peristaltic pumps inside the plant. The protective pipe will be laid from the head of each trench well to the plant wall in trenches

approximately 2 feet below final grade as shown on Figure 5. At the plant wall the tubing will be brought up along the wall and to floor level where the pumps will be located. From the pumps the tubing will be directed to the appropriate waste sump.

4.6 ASPHALT CAP PLACEMENT

After the monitor wells and groundwater interception trenches in Area A-9 are in place, a 3-inch thick asphalt cap will be placed over the site. Prior to placement of the asphalt cap, monitor well pipes and protective casing protruding above the ground surface will be cut so that well caps will be flush with the asphalt surface. The asphalt will be sloped to drain away from the plant and mounded near all wellheads. The asphalt cap will reduce substantially recharge of the perched water zones beneath Area A-9.

4.7 PUMPING FROM CUT-OFF TRENCHES

The sump well in each trench will be pumped as needed and the withdrawn water will be directed to the plant's wastewater treatment facility. Water extracted from Trench 1 will not be mixed with that from Trench 2. The pumping system will be automated and incorporate peristaltic pumps controlled by float switches or pressure sensors. The peristaltic pumps can handle approximately 5 gpm, and it is not expected that the steady state yield from the perched zone(s) will exceed this value. A separate pump will be used for each trench sump well, and the low level and high level cutoffs will be set 6 inches and 24 inches from the bottom, respectively. The frequency and duration of pumping will be automatically adjusted in accordance with the rate of accumulation of groundwater in the trenches. Wells B-1B, B-4, and B-6 will no longer be pumped once the cut-off trench system is operational.

4.8 DECONTAMINATION AND WASTE DISPOSAL/TREATMENT

Drilling, sampling, and excavation equipment will be cleaned to avoid cross-contamination and to prevent removal of contaminants from the site. The hollow-stem auger will be steam cleaned between borings using

a commercial detergent solution that contains metal chelating agents and then rinsed with potable water. The same procedure will be employed to decontaminate the backhoe bucket after trench excavation is completed. Decontamination of the split-barrel device between soil samples will be accomplished by a soapy water scrub followed by successive rinses with potable and deionized water. Protective gear worn by drilling, excavation, and supervisory personnel will be cleaned with soapy water or properly disposed of before leaving the site.

Waste from the drilling and construction operations will be in the form of cuttings, excavated soil, and discarded protective gear. The protective gear will be double-bagged and disposed of in a sanitary landfill. Cuttings and excavated soil will be temporarily stored in dumpsters until laboratory analysis of composite samples determines if these materials should be considered as hazardous. Any material determined to be hazardous will be disposed in a licensed RCRA landfill. It is anticipated that soils removed for Trench 1 will require disposal in a licensed landfill while those removed for Trench 2 will not.

The water pumped from the cut-off trenches, collected from decontamination procedures, and removed from monitor wells in obtaining groundwater samples will be treated at the plant wastewater treatment facility. This facility, which is used to treat concentrated wastewater from electroplating operations, includes unit processes for cyanide destruction by alkaline chlorination and for metal removal by hydroxide precipitation. Wastewater inputs to the plant from the proposed remedial actions will be low volume, relatively weak, and hence easily assimilable.

4.9 SAMPLING AND LABORATORY TESTING

Water samples will be taken from all monitor wells and from the cut-off trench sump wells in accordance with the schedule outlined in Section 3.8. Prior to sampling, the water levels in the monitor wells will be measured and then the wells will be pumped or bailed until three well

volumes have been removed. Samples from the monitor wells will be obtained by means of a 1-liter hand bailer. The procedure for sampling the cut-off trench sump wells will be to shut down the pump, measure the water level in the well, and then withdraw one or more 1-liter samples with a hand bailer. All water depth measurements will be made to the nearest 0.05 foot using either an electronic probe (m-scope) or a measuring tape with a "popper" attached at the bottom. The measuring device will be cleaned with distilled water after the water level measurement is made.

Water samples from the monitor and sump wells will be filtered (0.45 micron membrane filter) and then contained and preserved as indicated in Table 3. Soil samples obtained by split-barrel sampling will be put in glass containers with Teflon-lined lids. Duplicate samples ("blind repeats") and blanks (sampling equipment rinse water, with and without preservatives) will be prepared in the field to check analytical accuracy and to help identify any possible sources of contamination. All water and soil samples will be placed on ice in the field for shipment to the testing laboratory. The soil samples and most of the water samples (see Table 3) will be stored at 4°C in the laboratory.

Detailed records will be kept for each soil and water sample collected. This documentation, which will be recorded on standard forms, will include the following:

- name of person collecting the sample
- sample identification number
- sampling location
- date and time of sampling
- pertinent well or boring data (e.g., static water level, purging method, volumes purged, depth of sample, etc.)
- method of sampling
- volume of sample
- special characteristics of sample condition
- type of container
- special sample preparation (e.g., filtration)
- method of preservation

- analytical determinations, if any, performed in the field at the time of sampling, and results (e.g., pH, temperature, specific conductance, etc.)
- destination laboratory and date received

The sample records will be maintained in project files at Rizzo Associates.

Analyses of soil and water samples for pH, cyanide, silver, sulfate, nitrate, and chloride will be performed by a qualified laboratory. The analytical procedures that will be employed are listed in Table 4. Analyses of spiked samples, blind repeats, reagent blanks, and method blanks will be performed to insure analytical accuracy.

A chain-of-custody record will be maintained for the soil and water samples obtained at the site. The field engineer will initiate the chain-of-custody record by noting on a standard form the following information for each sample:

- name of person obtaining sample
- sample identification number
- sampling location
- date and time of sampling
- volume of sample
- analyses required
- laboratory destination

Other information such as preservatives added, sample condition, etc., shall be recorded as appropriate. The chain-of-custody record will be attached to the sealed sample container, and subsequent custody transfers will be recorded. A copy of the chain-of-custody record will be obtained from the analytical laboratory for project files upon transmittal of results of the analyses.

4.10 HEALTH AND SAFETY PROGRAM

In order to insure the health and safety of site personnel during the implementation of the proposed Remedial Plan, a formal health and safety program has been developed. This program, which will be managed by a Site Health and Safety Officer, is designed for use in conjunction with the following field activities:

- drilling and monitor well installation
- construction of cut-off trenches
- asphalt cap placement
- groundwater sampling

Included are measures for protection of plant personnel who will pass through Area A-9 on a daily basis after initial construction activities are completed. The health and safety program was developed by considering the nature, locations, and concentrations of contaminants at the site; the potential for personnel exposure during various site activities; and the effects of the contaminants on human health.

The major contaminants in the shallow subsurface at Area A-9 are cyanide and heavy metals. These inorganic contaminants are present in both the solid and liquid (aqueous) phases of the affected soil system, though predominantly in the latter. Two different, and apparently hydraulically isolated, zones of contaminated groundwater have been identified at Area A-9: a low pH zone containing metals, and a high pH zone containing metals and cyanide. Thus, the presence of acid and base solutions also must be considered. Metals and acid/base solutions are potentially toxic to humans via ingestion, and skin contact with acid/base solutions can result in irritation or burns. The acid and base solutions in the ground at Area A-9 are not sufficiently concentrated to cause burns. Cyanide can cause respiratory failure if it gets into the blood stream, and this can occur by ingestion or absorption through the skin of an aqueous solution containing cyanide, or by

inhalation of a gas containing cyanide. Hydrogen cyanide (HCN) gas, which is formed when a solution containing cyanide is adjusted to low pH, is a potential toxicant at Area A-9.

The most significant exposure pathways that will exist during the proposed remedial activities are physical contact and inhalation. From [his perspective, the contaminant of most concern is cyanide because both dermal exposure and inhalation can result in acute toxic effects. Measures to protect workers against dermal exposure to subsurface soil and water, and measures to prevent inhalation of HCN will be implemented at the site. The work area will be roped off and warning signs will be posted to prevent inadvertent exposure of plant personnel.

To protect against dermal exposure, site personnel will wear liquid and chemical resistant coveralls, boots or boot covers, gloves, and eye protection. This equipment will provide workers with EPA "Level-B" protection for dermal exposure. The protective equipment will be decontaminated with a soapy water scrub or properly disposed. Disposable equipment will be double bagged and placed in a sanitary landfill.

To protect against unacceptable inhalation exposures, air will be continuously monitored in the work area for HCN gas during drilling and construction operations. If HCN is detected in concentrations above five parts per million, work will stop, site personnel will be directed to an upwind location, and efforts will be made to control the source. [The Threshold Limit Value (TLV) set by OSHA for gaseous HCN is 10 ppm (29 CFR 1910.1000), so the specified action level is conservative.] If source control efforts and ventilation of the work area do not reduce the HCN level to below five parts per million, work will proceed using supplied air respirators. A troublesome boring may be sealed instead of continuing drilling with supplied air. Also, the work area limits will be expanded to prevent exposure of unprotected plant personnel. It is important to note that for work in the excavated trenches such as shoring and geomembrane/geotextile installation, mechanical ventilation

will be maintained at all times by blowing in surface air from a point outside Area A-9. In addition, HCN monitors will be placed directly in the trenches.

Emergencies will be dealt with in a manner to minimize risk to site personnel, plant employees, and the public. Site personnel will have a list of public response agencies that can be contacted depending on the nature of the situation. First aid kits containing cyanide antidote drugs and instructions for their use shall be available at the work site; a map with directions to the nearest hospital will be kept on-site during drilling and construction. All work will be conducted in groups of at least two workers so that one can seek help in case an emergency occurs.

Responsibility for implementing the health and safety program during remedial activities will rest with a Health and Safety Coordinator (HSC) while day to day activities will be managed by a Site Health and Safety Officer (SHSO). The HSC will train site personnel in various aspects of the health and safety program, including:

- site conditions and contaminants of concern
- possible health effects of these contaminants
- exposure pathways
- precautions to prevent exposure
- proper use of protective equipment
- decontamination procedures
- emergency procedures

All personnel will be familiar with the possible site hazards. A daily log will be kept by the SHSO during drilling and construction activities, and this will include a list of site personnel, protective equipment and procedures employed, monitoring results, and descriptions of activities and any unusual occurrences.

All personnel involved in remedial drilling, construction, and sampling activities will be participants in a medical surveillance program. Each worker will have an individually designed medical surveillance program based on the employee's potential exposure. The medical examination will include appropriate tests to evaluate the employee's ability to successfully use a respirator and other protective equipment. Medical records will be available as required by state and federal regulations.

After completion of the initial drilling and construction activities at the site, bi-weekly checks for HCN in the air will be made near the collection trenches by plant personnel. Release of HCN in amounts sufficiently large to produce unacceptable HCN concentrations in the ambient air is not likely based on measured water concentrations of cyanide in the low pH groundwater. Although highly unlikely, it is conceivable that some of the high pH groundwater bearing cyanide could make its way to Trench 1 which will contain acidic groundwater. If this happened HCN gas could be evolved. However, a steady and low flux rate of HCN gas would be involved because the high pH groundwater would be trickling at a slow rate into Trench 1. Bi-weekly air monitoring will detect unacceptable changes in HCN due to intermixing of groundwater zones. This routine monitoring will be conducted for six months and then the need for it will be re-assessed.

In addition to the health and safety procedures outlined here, the contractor will be required to comply with all laws, regulations, and guidelines applicable to work at this site, e.g., OSHA regulations, guidelines for shoring of trenches, etc.

5.0 SUMMARY

This Remedial Action Plan is an extension of that proposed in July 1986 for Area A-9 at the Westinghouse Beaver plant (Rizzo Associates, 1986b). The original Plan has been expanded to address comments submitted by PADER in October 1986 regarding the need for (i) faster removal of contaminants (particularly silver and cyanide) from the shallow subsurface, (ii) monitoring of the uncontaminated deep aquifer located beneath the plant, and (iii) details on how the excavated area on the site will be reclaimed.

To speed removal of contaminants from the perched water bearing zones near the surface, the construction of two cut-off trenches is proposed to enhance the collection of perched groundwater and to prevent future migration. Water collected in these trenches will be pumped to the plant wastewater treatment plant. The proposed groundwater interception system will enable more rapid collection of the contaminated near-surface water at the site. Analyses of soil and groundwater samples and chemical equilibrium considerations indicate that most of the contamination is in the aqueous phase; hence, removal of the perched water beneath Area A-9 will mitigate subsurface contamination and the potential for off-site transport. To reduce recharge to the near-surface perched zones, an asphalt cap will be placed over the site after the cut-off trenches are installed.

As part of the overall remediation of Area A-9, the former waste storage tank area will be reclaimed. This will be accomplished by removal of potentially contaminated soils, backfilling, sealing at the surface, regrading, and placement of an asphalt cap.

The expanded Plan also provides for additional monitor wells, both in the shallow subsurface and in the deep aquifer. Three more shallow monitor wells have been proposed to better define the extent of contamination, and two more deep monitor wells have been proposed in order to establish the hydraulic gradient and to define the groundwater quality in the deep aquifer. The resulting system of shallow and deep wells will enable detection of any horizontal migration of contaminated groundwater around the barrier trenches and any vertical migration to the deep aquifer underlying water bearing zones.

The quantity and chemical characteristics of groundwater collected in the cut-off trenches will be closely monitored, and data from the shallow and deep monitor wells will be obtained and evaluated regularly. After six months the effectiveness of the Remedial Plan will be assessed and future actions will be determined.

Respectfully submitted,

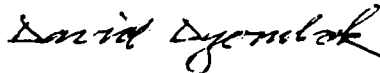

David A. Dzombak
Project Engineer

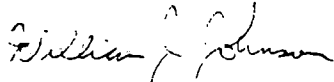

William J. Johnson
Project Manager

DAD/WJJ/are
Attachments

REFERENCES

- Baker, 1967, "Foundation Engineering Report for the Proposed Expansion at the Westinghouse Beaver Plant," report prepared for Westinghouse Electric Corporation, Michael Baker, Jr., Inc., Rochester, PA, March.
- Baker, 1971, "Subsurface Investigation for the Proposed Conversion of Boilers at the Westinghouse Beaver Plant," report prepared for Westinghouse Electric Corporation, Michael Baker, Jr., Inc., Rochester, PA, March.
- Hingston, F.J., Posner, A.M., and Quirk, J.P., 1972, "Anion Adsorption by Goethite and Gibbsite. I. The Role of the Proton in Determining Adsorption Envelopes," J. Soil Science, 23:177-192.
- Jenne, E.A., 1977, "Trace Element Sorption by Sediments and Soils: Sites and Processes," in Molybdenum in the Environment V.2, W.R. Chappell and K.K. Peterson (eds.), Marcel Dekker, New York, pp. 425-553.
- Morel, F.M.M., 1983, Principles of Aquatic Chemistry, Wiley, New York.
- Rhoades, J.D., 1982, "Soluble Salts," in Methods of Soil Analysis, Part 2. Chemical and Microbiological Properties, American Society of Agronomy, Madison, WI, Chapter 10.
- Rizzo Associates, 1985, "Evaluation of Existing Conditions, Westinghouse Beaver Plant, Area A-9," report prepared for Westinghouse Electric Corporation, Paul C. Rizzo Associates, Inc., Pittsburgh, PA, September 17.
- Rizzo Associates, 1986a, "Groundwater Assessment, Westinghouse Beaver Plant, Area A-9," report prepared for Westinghouse Electric Corporation, Paul C. Rizzo Associates, Inc., Pittsburgh, PA, May 28.
- Rizzo Associates, 1986b, "Remedial Action Plan, Westinghouse Beaver Plant, Area A-9," report prepared for Westinghouse Electric Corporation, Paul C. Rizzo Associates, Inc., Pittsburgh, PA, July 28.
- Ryden, J.C., McLaughlin, J.R. and Syers, J.K., 1977, "Mechanism of Phosphate Sorption by Soils and Hydrous Ferric Oxide Gel," J. Soil Science, 28:72-92.
- USEPA, 1979, "Methods for Chemical Analysis of Water and Wastes," Report EPA-600/4-79-020, U.S. Environmental Protection Agency, Environmental Monitoring and Support Laboratory, Cincinnati, OH.
- USEPA, 1982, "Test Methods for Evaluating Solid Waste. Physical/Chemical Methods," 2nd ed., Report SW-846, U.S. Environmental Protection Agency, Office of Solid Waste and Emergency Response, Washington, D.C.

TABLES

WPL 005 5554

SET 0020593

TABLE 1
AVAILABLE HYDROGEOLOGIC DATA
ON THE DEEP AQUIFER
BENEATH AREA A-9

<u>BORING</u>	<u>LOCATION</u>	<u>YEAR</u>	<u>SURFACE ELEVATION</u> (feet)	<u>APPROXIMATE BEDROCK ELEVATION</u> ⁽¹⁾ (feet)	<u>APPROXIMATE ELEVATION OF DEEP WATER TABLE</u> ⁽¹⁾ (feet)
B5	Area A-9	1985	763 ⁽²⁾	699.5	702
7 ⁽³⁾	B.A.Bldg.	1967	766.28	750	751.5
9A ⁽³⁾	B.A.Bldg.	1967	767.23	751	752.5
14 ⁽³⁾	B.A.Bldg.	1967	767.36	749.5	751.5
15 ⁽³⁾	B.A.Bldg.	1967	765.88	748	750

1. estimated from boring logs
2. estimated; surface elevation measured (Baker, 1971) in front of the adjacent Boiler House in 1971 was 763.2 feet
3. data from Baker, 1967.

WPL 005 5555



SET 0020594

TABLE 2
MINIMUM STANDARDS
FOR THE
COMPOSITE GEOMEMBRANE/GEOTEXTILE LINER*

A. NONWOVEN GEOTEXTILE

<u>PROPERTY</u>	<u>TEST PROCEDURE</u>	<u>STANDARD</u>
Tensile Strength (lbs)	ASTM D-1682	120
Elongation at Break (%)	ASTM D-1682	50
Coefficient of Water Permeability (cm/sec)	Constant Head (50mm) Falling Head (200-100mm)	0.1 0.15
Pore Size (EOS = Equivalent Opening Size)	U.S. Std. Sieve	70-100

B. FLEXIBLE GEOMEMBRANE

<u>PROPERTY</u>	<u>TEST PROCEDURE</u>	<u>STANDARD</u>
Tensile Strength (lbs)	ASTM D-751	200
Bonded Seam Strength (lbs)	ASTM D-751	150
Hydrostatic Resistance (lbs/in/min)	ASTM D-751	250
Change in Breaking Strength (%) with Soil Burial	ASTM D-3083	5

* These standards were determined by comparison of reported properties from a number of commercially available nonwoven geotextiles and flexible geomembranes.

WPL 005 5556



SET 0020595

TABLE 3
SAMPLE CONTAINERS AND PRESERVATION
METHODS FOR WATER SAMPLES^{1,2}

<u>PARAMETER</u>	<u>CONTAINER³</u>	<u>PRESERVATION</u>
Cyanide	P or G	NaOH to pH = 12, 4°C
Silver	P	HNO ₃ to pH<2
Sulfate	P or G	4°C
Nitrate	P or G	4°C
Chloride	P or G	None required
pH	Determined in field	

- 1 Methods for Chemical Analysis of Water and Wastes, USEPA, 1979.
 2 All samples will be filtered (0.45 micron membrane filter)
 3 P = plastic; G = glass

WPL 005 5557



SET 0020596

TABLE 4
ANALYTICAL PROCEDURES

PARAMETERS	SOIL	SAMPLE TYPE	WATER ⁽²⁾
Cyanide	9010 ⁽¹⁾		335.2
Copper	3010 ⁽¹⁾ , 220.1 ⁽²⁾		220.1 ⁽³⁾
Silver	3010 ⁽¹⁾ , 7760 ⁽¹⁾		272.1 ⁽³⁾
Sulfate	(A), 375.4 ⁽²⁾		375.3
Nitrate	(A), 352.1 ⁽²⁾		352.1
pH	(B)		150.1
Chloride	(A), 325.3 ⁽²⁾		325.3

- A. Methods of Soil Analysis, Part 2, Chemical and Microbiological Properties, A.L. Page (ed.) Section 10-2, American Society of Agronomy, Madison, WI, 1982.
- B. Field and Laboratory Methods Applicable to Overburden and Mine Soil, Zobeck, Schuller, Freeman, Black, West Virginia University, March 1978. [soil: water = 1:1]

1. Test Methods for Evaluating Solid Waste. Physical/Chemical Methods, Second Edition, SW-846, USEPA, 1982.
2. Methods for Chemical Analysis of Water and Wastes, USEPA, 1979.
3. Includes Acid Digestion for Total Metals.

FIGURES

WPL 005 5559

SET 0020598

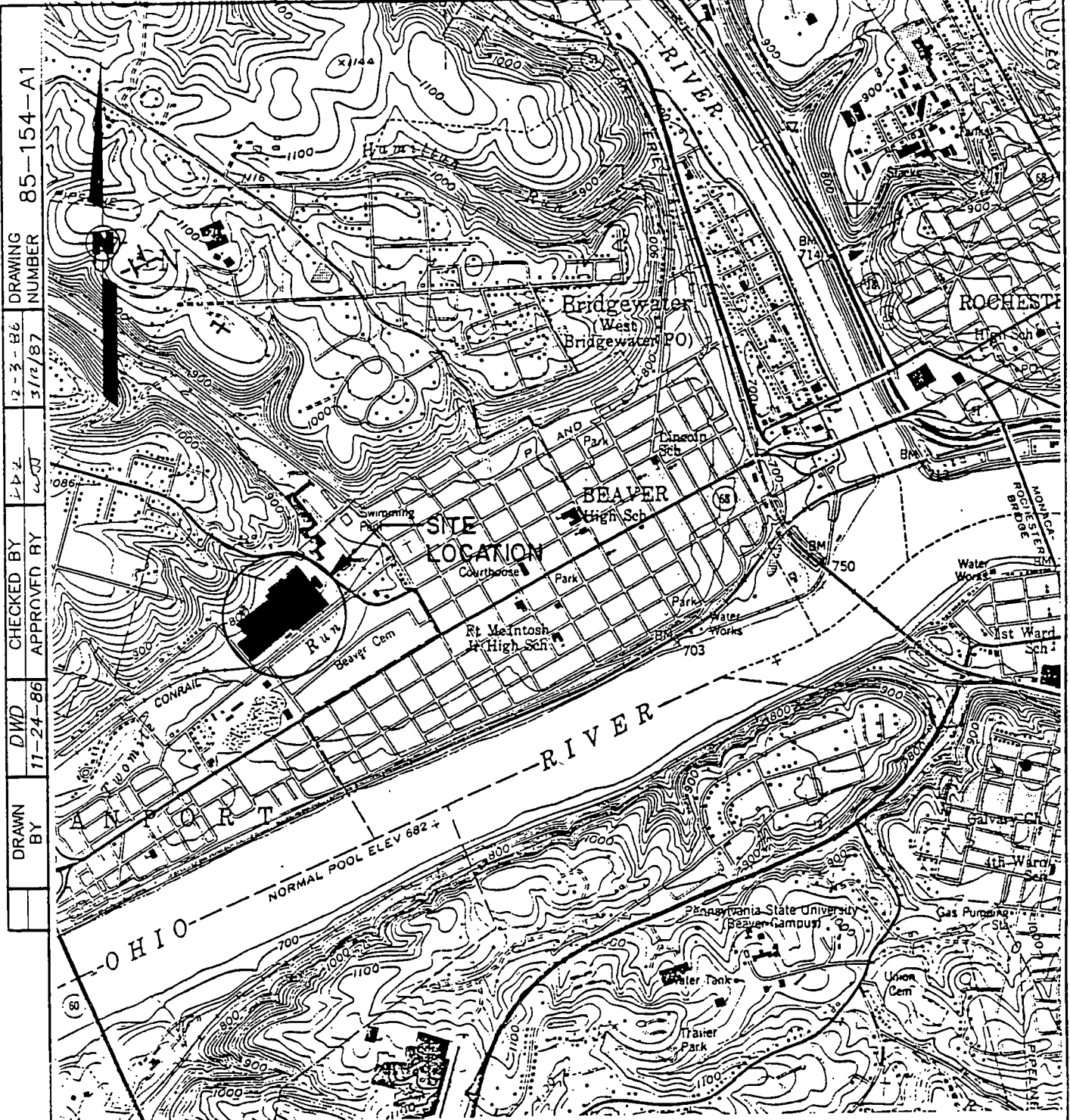

DRAWING NUMBER 85-154-A1
 12-3-86
 3/12/87
 CHECKED BY [Signature]
 APPROVED BY [Signature]
 DWD
 11-24-86
 DRAWN BY [Signature]

FIGURE 1
SITE LOCATION

PREPARED FOR
WESTINGHOUSE ELECTRIC CORPORATION
BEAVER, PENNSYLVANIA

REFERENCE:
 U.S.G.S. 7.5 MIN. TOPOGRAPHIC MAP
 OF BEAVER, PA. QUADRANGLE,
 DATED: 1953, PHOTOREVISED 1979
 SCALE: 1" = 2000'

PCR Paul C. Rizzo Associates, Inc.
CONSULTANTS

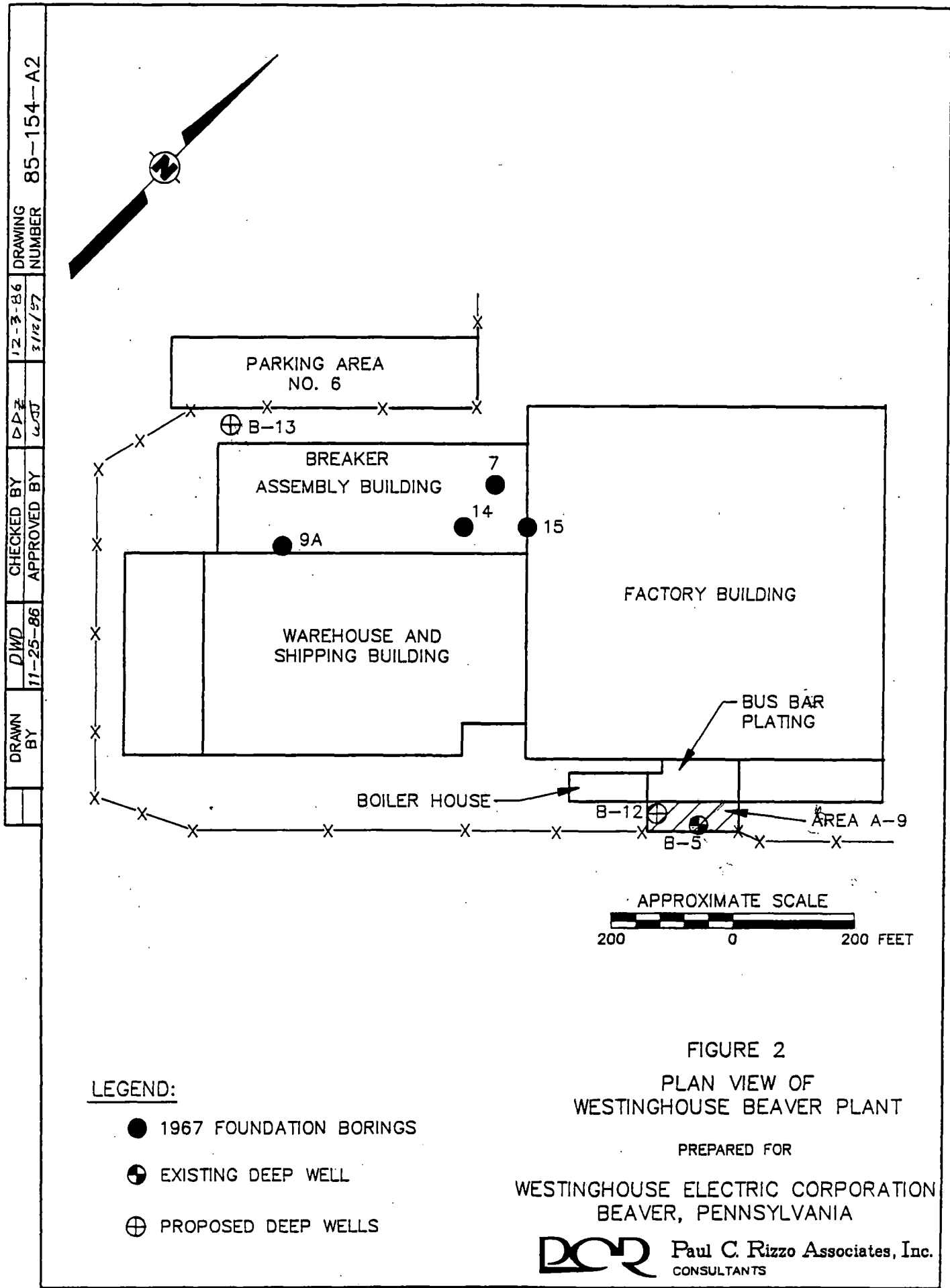

FIGURE 2
 PLAN VIEW OF
 WESTINGHOUSE BEAVER PLANT

PREPARED FOR
 WESTINGHOUSE ELECTRIC CORPORATION
 BEAVER, PENNSYLVANIA

DCR Paul C. Rizzo Associates, Inc.
 CONSULTANTS

Baker

2
15
20
21
B-1
B-2
B-3
B-4

B-1A
B-1B
B-2B

3-8=dry

WPL 005 5562

SET 0020601

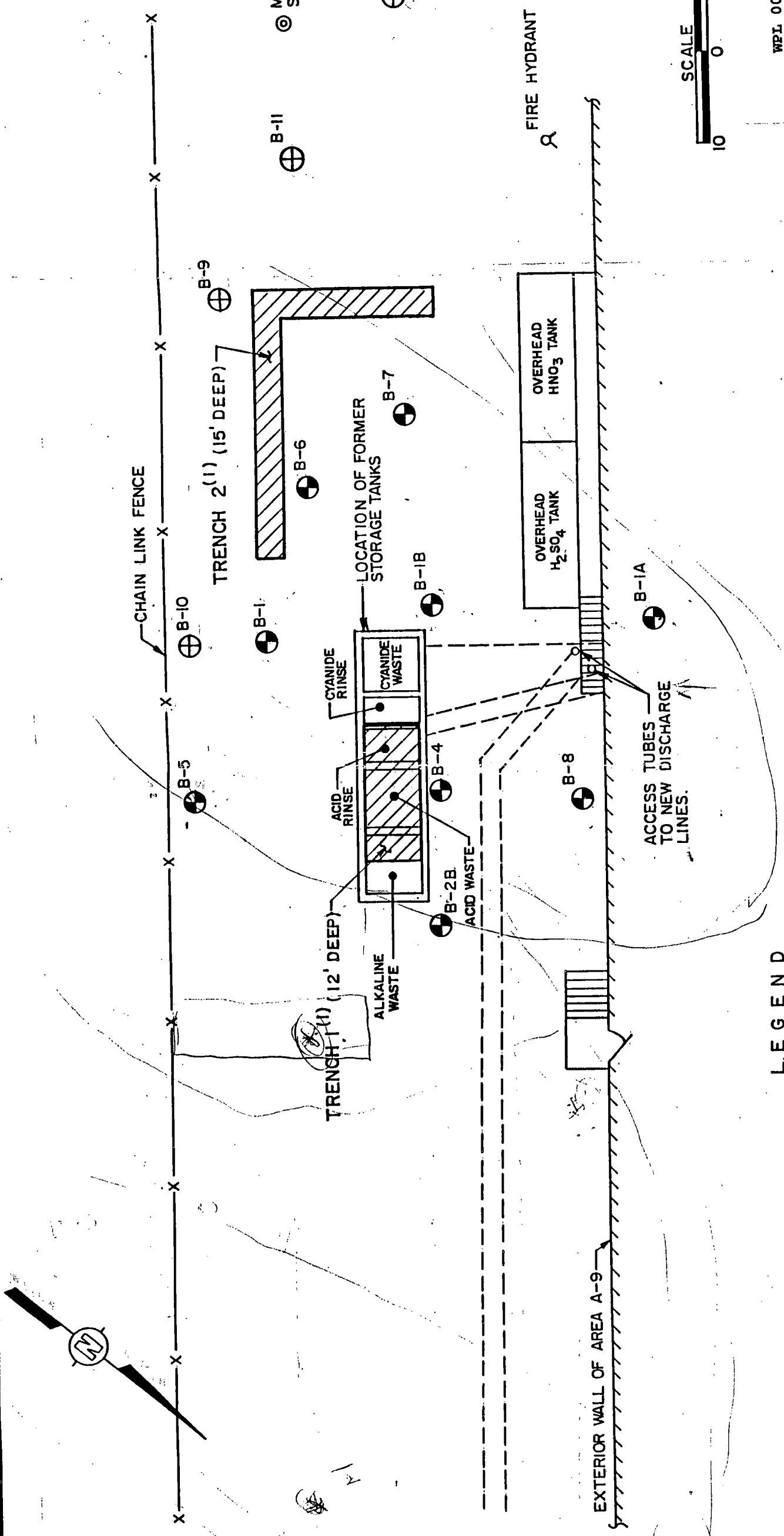

WPI 005 5563

FIGURE 3
AREA A-9:
LOCATION MAP OF EXISTING AND
PROPOSED WELLS, AND
PROPOSED CUT-OFF TRENCHES

PREPARED FOR

WESTINGHOUSE ELECTRIC CORPORATION
 BEAVER, PENNSYLVANIA

PCOR Paul C. Rizzo Associates, Inc.
 CONSULTANTS

LEGEND

- ⊕ EXISTING WELL
- ⊙ NEW WELL

NOTES:
 (1) EXACT LOCATION AND DIMENSIONS TO BE DETERMINED AFTER NEW WELLS ARE INSTALLED AND EXPLORATORY BORING PROGRAM IS COMPLETED.

DRAWN BY	TEJ	CHECKED BY	DPK	DRAWING NUMBER	85-154-B12
APPROVED BY	WJD	DATE	3/12/87		
	7-20-85				

DRAWN BY	CHECKED BY	DATE	DRAWING NUMBER
	TEJ	3-11-87	85-154-A7
	APPROVED BY	3/12/87	
	WJT		
	2-9-87		

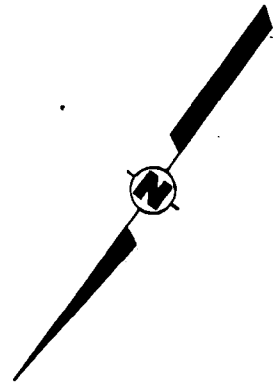
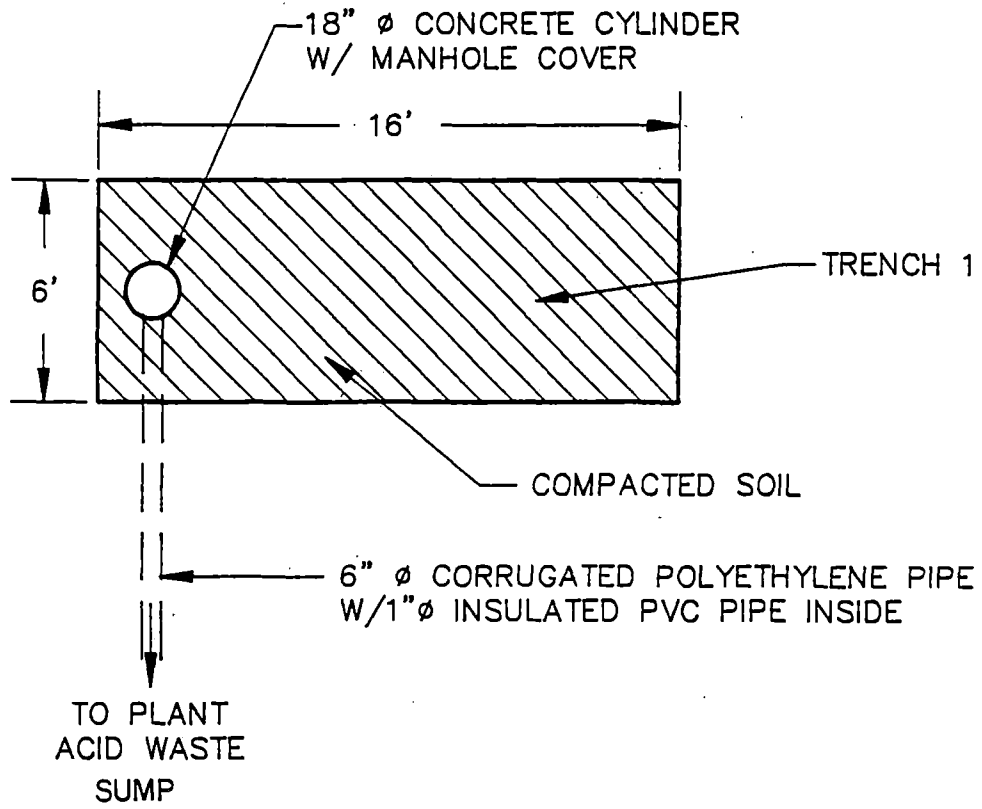

WPL 005 5564

FIGURE 4A

TRENCH NO. 1 - PLAN VIEW

PREPARED FOR

WESTINGHOUSE ELECTRIC CORPORATION
BEAVER, PENNSYLVANIA

PCRA Paul C. Rizzo Associates, Inc.
CONSULTANTS

SET 0020603

DRAWING NUMBER 85-154-A3	
2-11-87	1/12/87
DDZ	WST
CHECKED BY	APPROVED BY
TEJ	11-25-86
DRAWN BY	

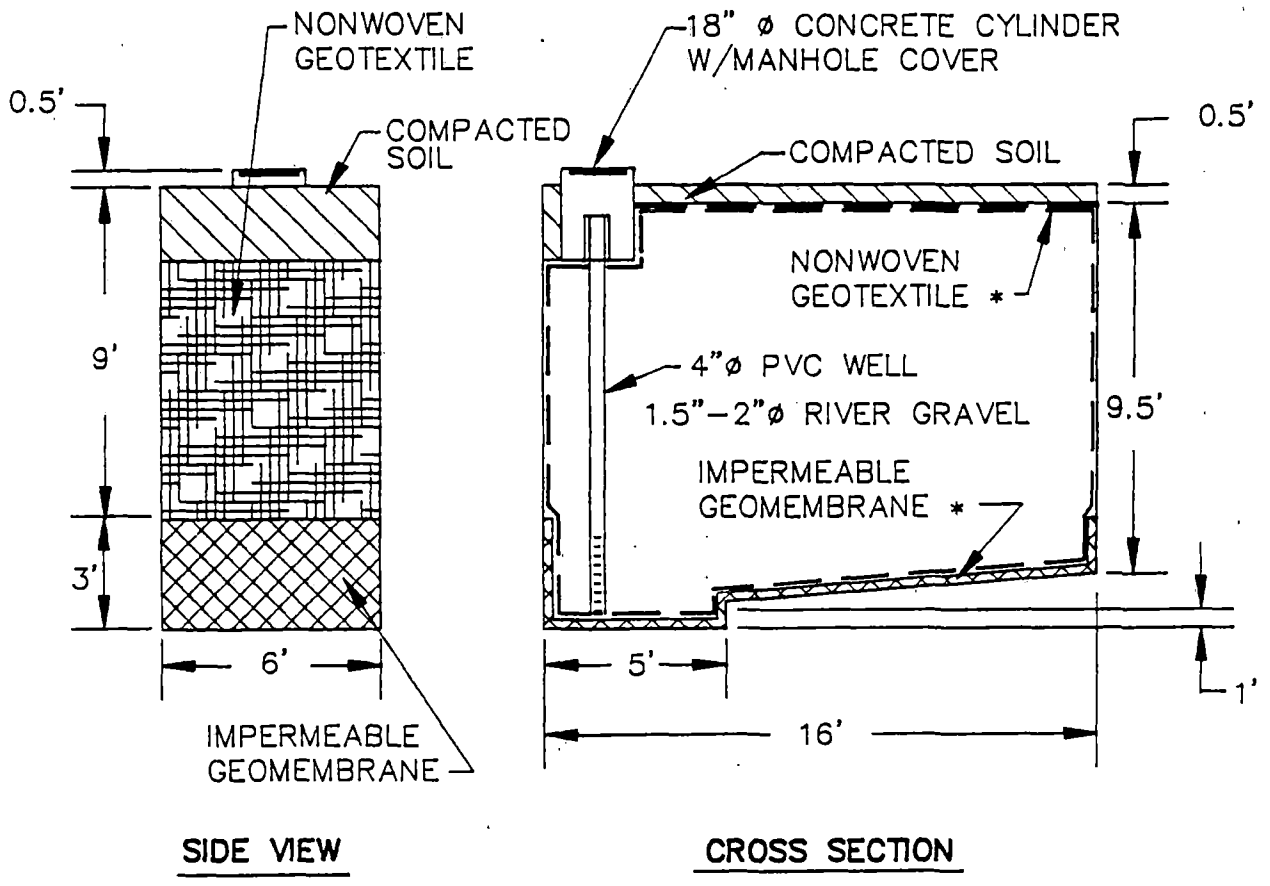

WPL 005 5565

FIGURE 4B

TRENCH NO. 1
CROSS SECTION AND SIDE VIEW

PREPARED FOR

WESTINGHOUSE ELECTRIC CORPORATION
BEAVER, PENNSYLVANIA

* THICKNESS EXAGGERATED

DCR Paul C. Rizzo Associates, Inc.
CONSULTANTS

SET 0020604

DRAWN BY	TEJ	CHECKED BY	3-11-87	DRAWING NUMBER	85-154-A4
	11-25-86	APPROVED BY	3/12/87		

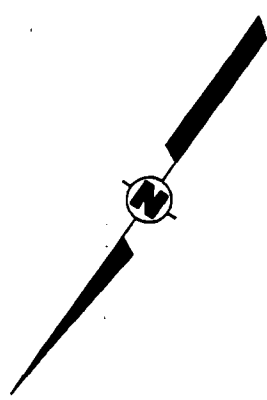
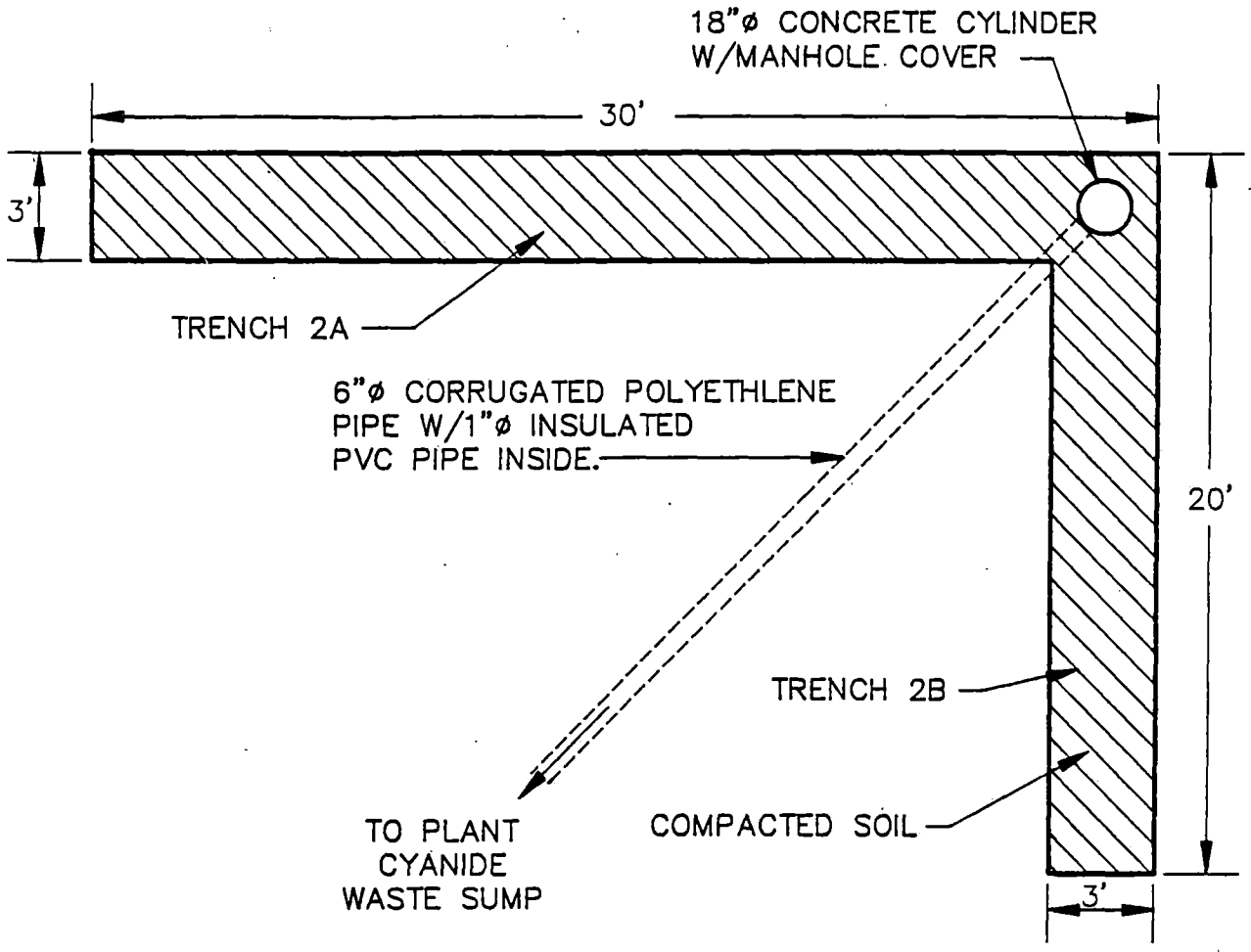

WPL 005 5566

FIGURE 4C

TRENCH NO. 2-PLAN VIEW

PREPARED FOR

WESTINGHOUSE ELECTRIC CORPORATION
BEAVER, PENNSYLVANIA

DCR Paul C. Rizzo Associates, Inc.
CONSULTANTS

SET 0020605

DRAWING NUMBER	85-154-A5
CHECKED BY	P-P-2
APPROVED BY	J-J-F
DRAWN BY	
DWD	11-25-86
2-11-87	3/12/87

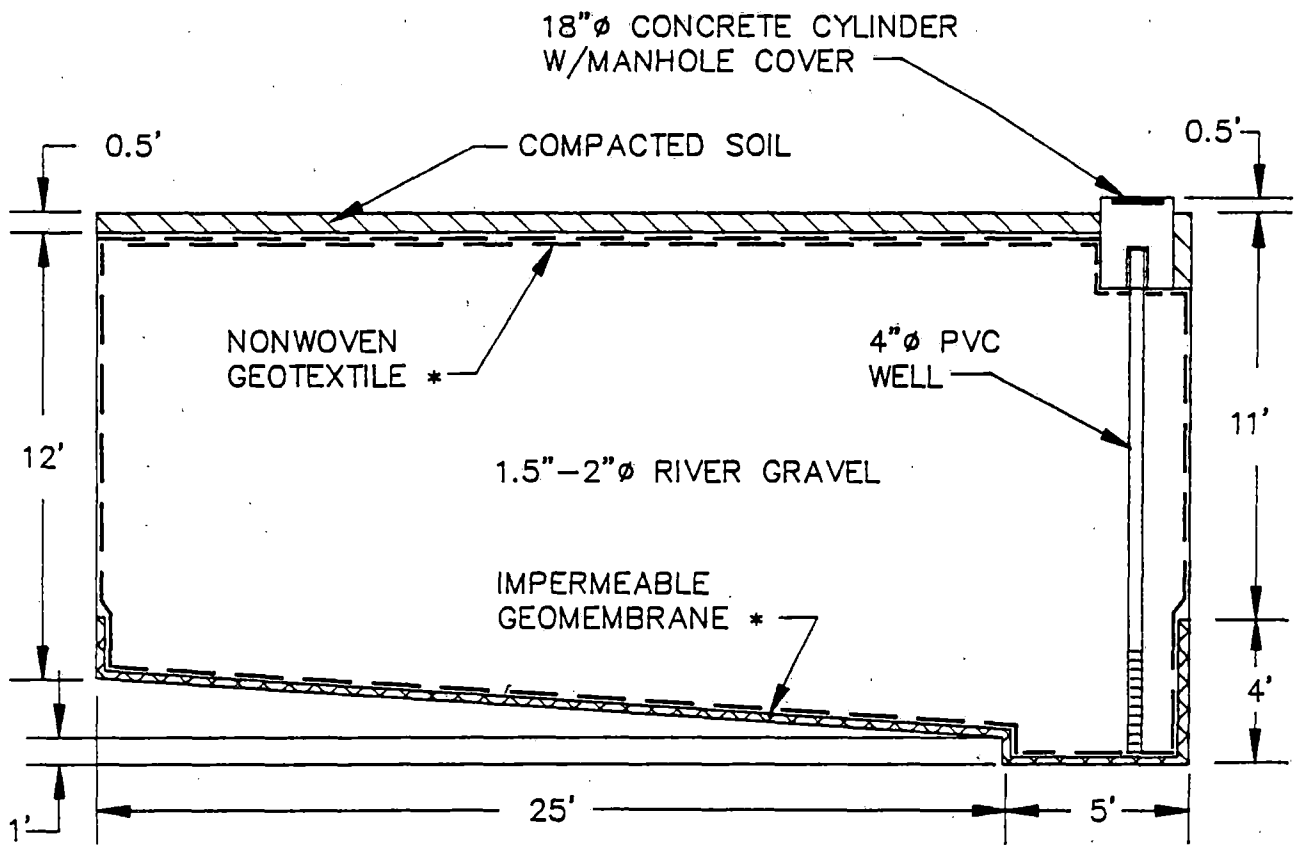

WPL 005 5567

FIGURE 4D

TRENCH 2A - CROSS SECTION

PREPARED FOR

WESTINGHOUSE ELECTRIC CORPORATION
BEAVER, PENNSYLVANIA

PCR Paul C. Rizzo Associates, Inc.
CONSULTANTS

* THICKNESS EXAGGERATED

SET 0020606

DRAWN BY	DWD	CHECKED BY	DAD	2-11-87	DRAWING NUMBER	85-154-A6
	17-25-86	APPROVED BY	WAD	3/12/87		

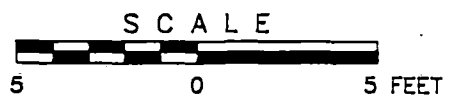
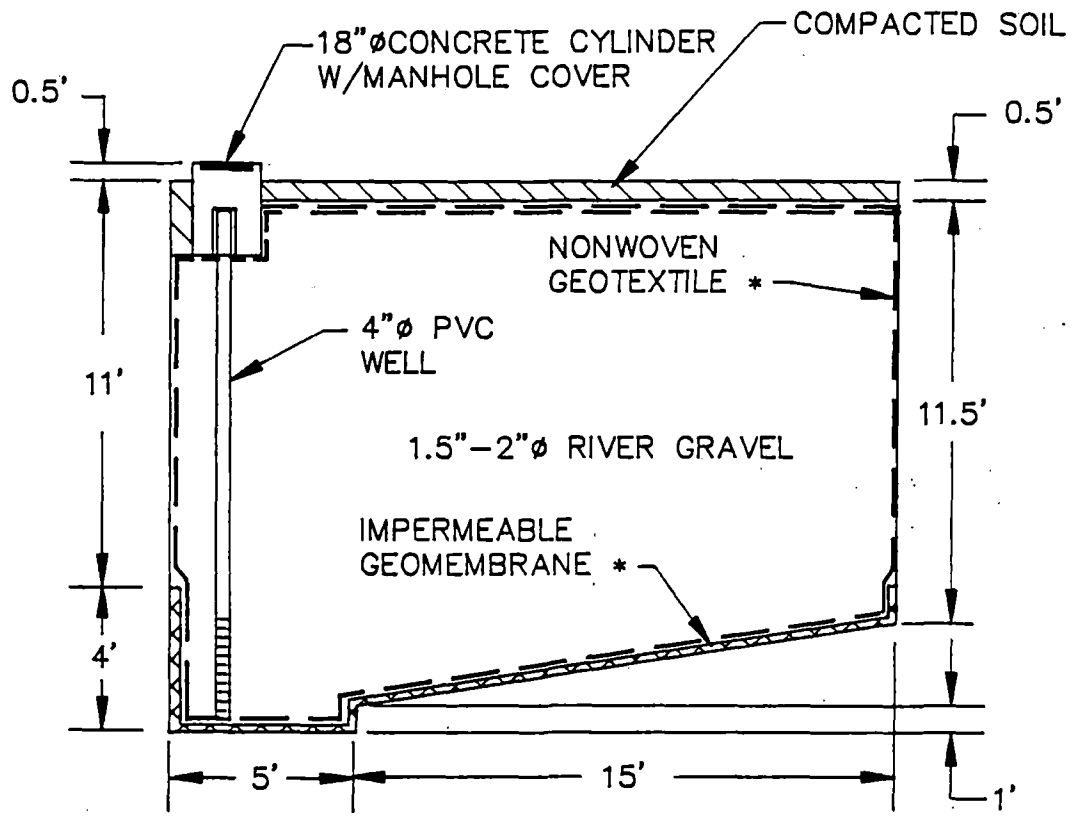

WPL 005 5568

FIGURE 4E
TRENCH 2B - CROSS SECTION

PREPARED FOR
WESTINGHOUSE ELECTRIC CORPORATION
BEAVER, PENNSYLVANIA

* THICKNESS EXAGGERATED

PCR Paul C. Rizzo Associates, Inc.
CONSULTANTS

SET 0020607

DRAWN BY: []
 CHECKED BY: TEJ 2-24-87
 APPROVED BY: []
 3-11-87 3/12/87
 DRAWING NUMBER: 85-154-A9

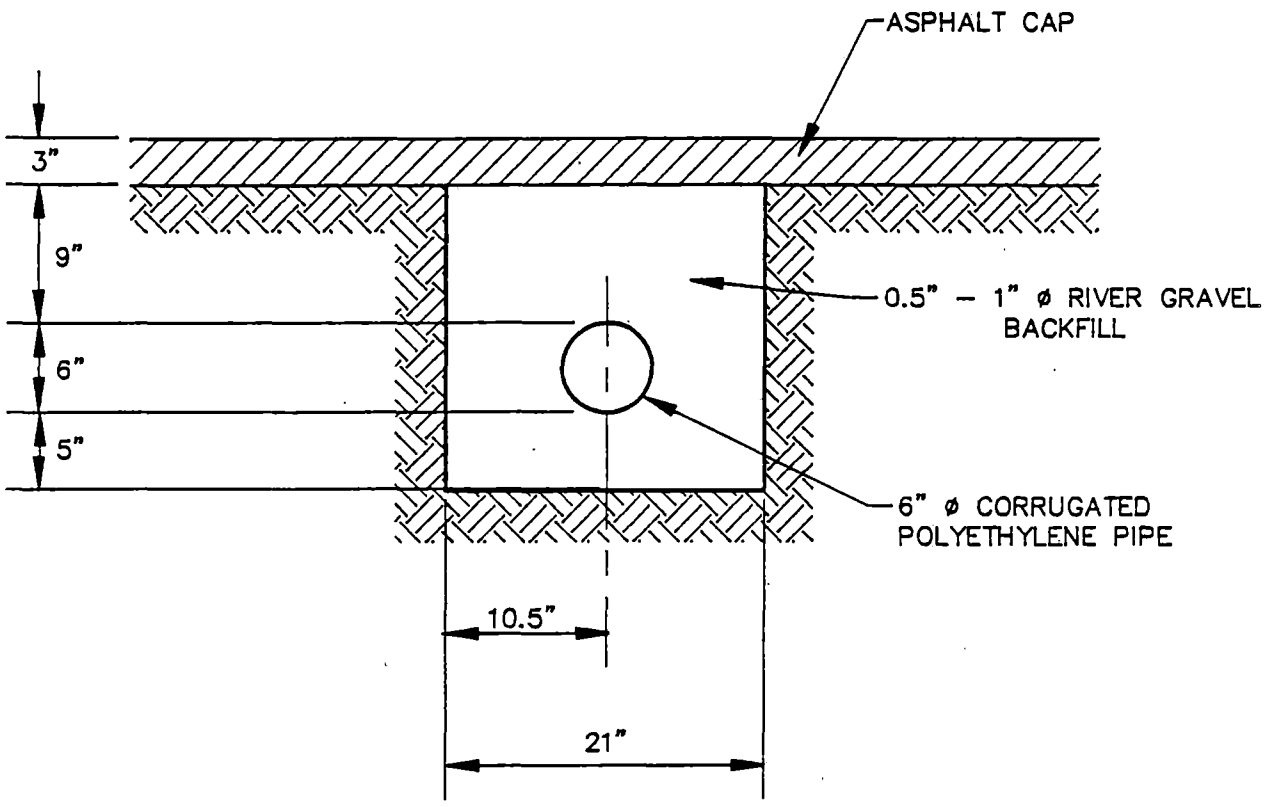

FIGURE 5

DETAIL FOR TRENCHES FROM
SUMP WELLHEADS TO PLANT WALL

PREPARED FOR

WESTINGHOUSE ELECTRIC CORPORATION
BEAVER, PENNSYLVANIA

WPL 005 5569

Paul C. Rizzo Associates, Inc.
CONSULTANTS

SET 0020608

APPENDIX A

RECENT DATA FROM AREA A-9

WPL 005 5570



SET 0020609

APPENDIX A

RECENT DATA FROM AREA A-9

Pumping and monitoring data for the wells in Area A-9 from June to October, 1986, are summarized in Tables A-1 and A-2; the raw data follow these summary tables. These data were obtained by Westinghouse personnel at the Beaver plant. Though not extensive, the data indicate some trends worth noting. First, the amount of water pumped from the wells seems to be directly related to rainfall. This means that the perched zone is being easily recharged. Second, the cyanide contamination appears to be moving in a southwesterly direction since cyanide concentrations decreased significantly in Wells B-1B and B-6, but increased significantly in Well B-7 over the five months (refer to Figure 3 for well locations). Cyanide concentrations at Well B-1, to the south of Well B-1B, essentially remained the same from June to October. However, Well B-1 is damaged and hence the data are suspect.

The logo consists of the letters 'DOR' in a stylized, bold, serif font. The 'D' and 'O' are connected, and the 'R' is separate. The letters are black and have a slightly shadowed or 3D effect.

WPL 005 5571

SET 0020610

TABLE A-1
PUMPING DATA

<u>WEEK ENDING</u>	<u>WEATHER</u> **	FLOW RATE (GPH)*					
		<u>WELL B-1B</u>		<u>WELL B-4</u>		<u>WELL B-6</u>	
06-06-86	Dry	0.05		2.03		0.03	
06-13-86	Dry	0.07		9.23		8.28	
06-21-86	Dry	--	0.05	--	4.42	--	2.84
06-27-86	Dry	0.04		2.00		0.22	
07-04-86	Rain	1.91		21.18		24.00	
07-11-86	Rain	0.32		13.85		8.37	
07-18-86	Rain	0.10	0.78	10.75	15.26	1.90	3.71
08-01-86	Dry	--		--		--	
08-08-86	Dry	0.04		1.51		0.11	
08-15-86	Dry	0.03		2.35		0.66	
08-22-86	Dry	<0.01	0.03	1.32	1.73	0.05	0.27
08-29-86	Dry	0.04		1.73		0.25	
09-05-86	Dry	0.03		--		0.05	
09-12-86	Dry	--	0.11	2.00	3.54	--	3.21
09-26-86	Rain	0.18		5.07		6.37	
10-03-86	Rain	0.14		7.06		8.78	
10-10-86	Dry	0.09		3.53		0.00	
10-17-86	Rain	0.01	0.05	4.62	4.59	0.20	1.81
10-24-86	Dry	0.01		6.00		0.04	
10-31-86	Dry	<0.01		1.76		0.01	

* Flow rates were measured one day per week. The numbers between the columns are average flow rates for the month, calculated from the measured flow rates.

** Based on general weather conditions as indicated by plant personnel; "Rain" means "medium" to "heavy" rain was reported for two or more days in the week.

TABLE A-2

CHRONOLOGY OF CYANIDE CONCENTRATIONS
IN SEVERAL WELLS AT AREA A-9

SAMPLE DATE	TOTAL CYANIDE (mg/L)				
	<u>WELL B-1</u>	<u>WELL B-1B</u>	<u>WELL B-4</u>	<u>WELL B-6</u>	<u>WELL B-7</u>
5/85		2300	11		
11/85	45	1100	18		180
12/85		1400	28	91	290
6/24/86		2300		52	805
7/23/86	130	1530		6.8	845
8/28/86	110	1700	11	2.5	830
9/25/86	130	550	3.9	0.99	905

WPL 005 5573



SET 0020612

WELL PUMPING & MONITORING LOG

WEEK OF 6-2-86

DATE	HOURS PUMPED		
	WELL #1B	WELL #6	WELL #4
<u>6-2-86</u>	<u>24</u>	<u>24</u>	<u>24</u>
<u>6-3-86</u>	<u>24</u>	<u>24</u>	<u>24</u>
<u>6-4-86</u>	<u>24</u>	<u>24</u>	<u>24</u>
<u>6-5-86</u>	<u>24</u>	<u>24</u>	<u>24</u>
<u>6-6-86</u>	<u>24</u>	<u>23.8</u>	<u>23.8</u>
_____	_____	_____	_____
_____	_____	_____	_____

DATE 6-7-86

WELL NO.	WATER LEVEL (BELOW GRADE)	Ph	FLOW (GPH)	WELL NO.	WATER LEVEL (BELOW GRADE)
1B	<u>13'-0 1/2"</u>	<u>9.5</u>	<u>.05</u>	1	<u>13'-5"</u>
4	<u>12'-9 1/4"</u>	<u>2.8</u>	<u>2.03</u>	7	<u>16'-1"</u>
6	<u>18'-3 3/4"</u>	<u>9.0</u>	<u>.03</u>	8	<u>39'-3 1/4"</u>
2B	<u>DRY</u>			1A *	<u>6'-0"</u>

WEATHER COND, DRY

* BELOW FLOOR ELEVATION

NOTES: 6-6 CHANGED PUMP TUBING ON WELL

4 + 6. 1:15 PM

WELL PUMPING & MONITORING LOG

WEEK OF

6-9-86

DATE	HOURS PUMPED		
	WELL #1B	WELL #6	WELL #4
<u>6-9-86</u>	<u>24</u>	<u>23.8</u>	<u>23.8</u>
<u>6-10-86</u>	<u>24</u>	<u>24</u>	<u>24</u>
<u>6-11-86</u>	<u>24</u>	<u>24</u>	<u>23.8</u>
<u>6-12-86</u>	<u>24</u>	<u>24</u>	<u>24</u>
<u>6-13-86</u>	<u>24</u>	<u>24</u>	<u>24</u>
_____	_____	_____	_____
_____	_____	_____	_____

DATE 6-11-86

WELL NO.	WATER LEVEL (BELOW GRADE)	Ph	FLOW (GPH)	WELL NO.	WATER LEVEL (BELOW GRADE)
1B	<u>12'-10³/₄"</u>	<u>9.7</u>	<u>.07</u>	1	<u>13'-1"</u>
4	<u>12'-10¹/₄"</u>	<u>3.0</u>	<u>9.23</u>	7	<u>15'-8¹/₂"</u>
6	<u>18'-2"</u>	<u>8.7</u>	<u>8.28</u>	8	<u>39'-4¹/₄"</u>
2B	<u>DRY</u>			1A *	<u>5'-1³/₄"</u>

* BELOW FLOOR ELEVATION

NOTES: 6-9 CHANGED PUMP TUBING ON WELL
#486, 7:30 AM. 6-11 CHANGED PUMP TUBING
ON WELL # 6
6-9 Medium Rain.

WPL 005 5575

SET 0020611

WELL PUMPING & MONITORING LOG

WEEK OF 6-16-86

DATE	HOURS PUMPED		
	WELL #1B	WELL #6	WELL #4
<u>6-16-86</u>	<u>0</u>	<u>0</u>	<u>0</u>
<u>6-17-86</u>	<u>0</u>	<u>0</u>	<u>0</u>
<u>6-18-86</u>	<u>0</u>	<u>0</u>	<u>0</u>
<u>6-19-86</u>	<u>0</u>	<u>0</u>	<u>0</u>
<u>6-20-86</u>	<u>0</u>	<u>0</u>	<u>0</u>
<u>6-21-86</u>	<u>24</u>	<u>24</u>	<u>24</u>
_____	_____	_____	_____

DATE: _____

WELL NO.	6-20-86		6-21-86		WELL NO.	WATER LEVEL (BELOW GRADE)
	WATER LEVEL (BELOW GRADE)	Ph	FLOW (GPH)			
1B	<u>7'-11 1/2"</u>	<u>9.8</u>	_____	_____	1	<u>13'-1"</u>
4	<u>6'-9 1/4"</u>	<u>2.9</u>	_____	_____	7	<u>15'-7"</u>
6	<u>12'-2"</u>	<u>9.2</u>	_____	_____	8	<u>39'-3 3/4"</u>
2B	<u>DRY</u>	_____	_____	_____	1A *	<u>5'-4"</u>

* BELOW FLOOR ELEVATION

NOTES: REPLACED ALL PUMP TUBING 6-21-86

WPL 005 5576

SET 0020615

ANALYSIS REPORT



**LANCY
LABORATORIES**
Division, Lancy International, Inc.
525 W. New Castle St., P.O. Box 400
Zellenople, Pennsylvania 16063

An Alcoa Separations Technology Company

Westinghouse Electric Corporation
One Tuscarawas Road
Beaver, PA 15009

Attention: Ted Kasper

Report Date 7/2/86
Collected 6/24/86 by _____
Received 6/25/86 by LS
Analyzed 6/25 - 7/1/86 by Staff
No. of Samples 3
P.O. # 30-B-312100

Well Analysis for Cyanide

Order Entry #26

Sample #	Well 1B 06-862501	Well 6 06-862502	Well 7 06-82503
Lab Reference #	<u>20616</u>	<u>20617</u>	<u>20618</u>
<u>Parameter</u>	<u>(mg/L)</u>	<u>(mg/L)</u>	<u>(mg/L)</u>
Cyanide, Total	2300	52	805

C. John Ritzert, Manager-Technical Services

WELL PUMPING & MONITORING LOG

WEEK OF 6-23-86

DATE	HOURS PUMPED			WEATHER COND.
	WELL #1B	WELL #6	WELL #4	
<u>6-23-86</u>	<u>24</u>	<u>24</u>	<u>24</u>	DRY
<u>6-24-86</u>	<u>24</u>	<u>24</u>	<u>24</u>	DRY
<u>6-25-86</u>	<u>24</u>	<u>23.8</u>	<u>24</u>	DRY
<u>6-26-86</u>	<u>23.8</u>	<u>24</u>	<u>23.8</u>	DRY
<u>6-27-86</u>	<u>24</u>	<u>24</u>	<u>24</u>	RAIN IN EVENING
_____	_____	_____	_____	
_____	_____	_____	_____	

DATE 6-25-86

WELL NO.	WATER LEVEL (BELOW GRADE)	Ph	FLOW (GPH)	WELL NO.	WATER LEVEL (BELOW GRADE)	pH
1B	_____	<u>10.5</u>	<u>0.04</u>	1	_____	<u>6.8</u>
4	_____	<u>2.9</u>	<u>2.0</u>	7	_____	<u>7.9</u>
6	_____	<u>11.2</u>	<u>0.22</u>	8	<u>TO DEEP</u>	_____
2B	<u>DRY</u>	_____	_____	1A *	_____	<u>10.1</u>

* BELOW FLOOR ELEVATION

NOTES: 6-25 REPLACED TUBING # 6 6-26 REPLACED
TUBING 1B + 4

WPL 005 5578

SET 0020617

WELL PUMPING & MONITORING LOG

WEEK OF 6-30-86

DATE	HOURS PUMPED			WEATHER COND
	WELL #1B	WELL #6	WELL #4	
<u>6-30-86</u>	<u>24</u>	<u>23.8</u>	<u>23.8</u>	LIGHT TO MED RAIN. P.M. DRY
<u>7-1-86</u>	<u>23.8</u>	<u>24</u>	<u>24</u>	
<u>7-2-86</u>	<u>24</u>	<u>23.8</u>	<u>23.8</u>	MED. TO HEAVY RAIN. AM DRY
<u>7-3-86</u>	<u>24</u>	<u>24</u>	<u>24</u>	

DATE 7-2-86

WELL NO.	WATER LEVEL (BELOW GRADE)	Ph	FLOW (GPH)	WELL NO.	WATER LEVEL (BELOW GRADE)
1B	<u>12'-10"</u>	<u>9.5</u>	<u>1.91</u>	1	<u>14'-0"</u>
4	<u>12'-9"</u>	<u>3.1</u>	<u>21.18</u>	7	<u>15'-5"</u>
6	<u>17'-6"</u>	<u>8.7</u>	<u>24.0</u>	8	<u>39'-5"</u>
2B	<u>DRY</u>			1A *	<u>5'-0"</u>

* BELOW FLOOR ELEVATION

NOTES: 6-30 REPLACED TUBING IN #4 + #6
7-1 REPLACED TUBING IN #1B
7-2 " " " " #4 + #6
7-2 PUMPED OUT A9 ISLAND PIT

WPL 005 5579

SET 0020618

WELL PUMPING & MONITORING LOG

WEEK OF 7-7-86

DATE	HOURS PUMPED			WEATHER COND
	WELL #1B	WELL #6	WELL #4	
<u>7-7-86</u>	<u>23.8</u>	<u>23.8</u>	<u>23.8</u>	DRY
<u>7-8-86</u>	<u>24</u>	<u>24</u>	<u>24</u>	HEAVY RAIN
<u>7-9-86</u>	<u>23.8</u>	<u>24</u>	<u>24</u>	HEAVY RAIN
<u>7-10-86</u>	<u>24</u>	<u>23.8</u>	<u>23.8</u>	RAIN
<u>7-11-86</u>	<u>24</u>	<u>24</u>	<u>23.8</u>	RAIN
_____	_____	_____	_____	
_____	_____	_____	_____	

DATE _____

WELL NO.	WATER LEVEL (BELOW GRADE)	Ph	FLOW (GPH)	WELL NO.	WATER LEVEL (BELOW GRADE)
1B	<u>12'-9"</u>	<u>9.5</u>	<u>.32</u>	1	<u>13'-6"</u>
4	<u>12'-10"</u>	<u>3.5</u>	<u>13.85</u>	7	<u>15'-9"</u>
6	<u>9'-4"</u>	<u>8.8</u>	<u>8.37</u>	8	<u>39'-7"</u>
2B	<u>DRY</u>			1A *	<u>5'-3"</u>

* BELOW FLOOR ELEVATION

NOTES: 7-7 CHANGED TUBING IN WELLS # 4, 6 & 1B
7-9 CHANGED TUBING IN WELL # 1B
7-10 CHANGED TUBING IN WELLS # 4 & 6
7-11 CHANGED TUBING IN WELL # 4

WPL 005 5580

SET 0020619

WELL PUMPING & MONITORING LOG

WEEK OF

7-14-86

DATE	WELL #1B	HOURS PUMPED WELL #6	WELL #4	WEATHER COND.
<u>7-14-86</u>	<u>23.8</u>	<u>23.8</u>	<u>23.8</u>	DRY
<u>7-15-86</u>	<u>24</u>	<u>24</u>	<u>24</u>	DRY
<u>7-16-86</u>	<u>24</u>	<u>24</u>	<u>23.8</u>	RAIN
<u>7-17-86</u>	<u>24</u>	<u>23.8</u>	<u>24</u>	RAIN
<u>7-18-86</u>	<u>23.8</u>	<u>24</u>	<u>23.8</u>	DRY
_____	_____	_____	_____	
_____	_____	_____	_____	

DATE _____

WELL NO.	WATER LEVEL (BELOW GRADE)	Ph	FLOW (GPH)	WELL NO.	WATER LEVEL (BELOW GRADE)
1B	<u>12'-10"</u>	<u>3.4</u>	<u>.10</u>	1	<u>13'-10"</u>
4	<u>12'-9"</u>	<u>9.5</u>	<u>10.75</u>	7	<u>15'-11"</u>
6	<u>18'-1"</u>	<u>8.9</u>	<u>1.90</u>	8	<u>39'-4"</u>
2B	<u>DRY</u>			1A*	<u>5'-4"</u>

* BELOW FLOOR ELEVATION

NOTES: 7-14-86 CHANGED TUBING IN WELLS # 1B, 4 & 6
7-16-86 CHANGED TUBING IN WELL # 4
7-17-86 CHANGED TUBING IN WELL # 6
7-18-86 CHANGED TUBING IN WELL # 4 & 1B

WPL 005 5581

SET 0020620

ANALYSIS REPORT



LANCY LABORATORIES
 Division, Lancy International, Inc.
 525 W. New Castle St., P.O. Box 400
 Zellenople, Pennsylvania 16063

An Alcoa Separations Technology Company

Westinghouse Electric Corporation
 One Tuscarawas Road
 Beaver, PA 15009

 Attention: Ted Kasper

Report Date 8/4/86
 Collected 7/23/86 by West-B
 Received 7/23/86 by LS
 Analyzed 7/23 - 7/31/86 by Staff
 No. of Samples 4
 P.O. # L-30-B-312100

Well Samples

Order Entry #26

<u>Lab Reference #</u>	<u>Well #</u>	<u>Sample #</u>	<u>Cyanide, Total (mg/L)</u>
20993	1	07-862301	130
20994	1B	07-862302	1530
20995	6	07-862303	6.8
20996	7	07-862304	845

 C. John Ritzert, Manager-Technical Services

WELL PUMPING & MONITORING LOG

WEEK OF 7-28-86

DATE	HOURS PUMPED			WEATHER COND.
	WELL #1B	WELL #6	WELL #4	
<u>7-28</u>	<u>24</u>	<u>24</u>	<u>24</u>	<u>DRY</u>
<u>7-29</u>	<u>24</u>	<u>24</u>	<u>24</u>	<u>DRY</u>
<u>7-30</u>	<u>24</u>	<u>24</u>	<u>24</u>	<u>DRY</u>
<u>7-31</u>	<u>24</u>	<u>24</u>	<u>24</u>	<u>DRY</u>
<u>8-1</u>	<u>24</u>	<u>24</u>	<u>24</u>	<u>DRY</u>
_____	_____	_____	_____	
_____	_____	_____	_____	

DATE _____

WELL NO.	WATER LEVEL (BELOW GRADE)	Ph	FLOW (GPH)	WELL NO.	WATER LEVEL (BELOW GRADE)
1B	_____	_____	_____	1	_____
4	_____	_____	_____	7	_____
6	_____	_____	_____	8	_____
2B	_____	_____	_____	1A *	_____

* BELOW FLOOR ELEVATION

NOTES: WELLS NOT CHECKED FOR WATER LEVEL,
PH OR FLOW RATE. KEN Mc MILLEN ON
VACATION

ABOVE INFORMATION PER. N. BECK

WELL PUMPING & MONITORING LOG

WEEK OF 8-4-86

DATE	HOURS PUMPED WELL #1B	WELL #6	WELL #4	WEATHER COND.
<u>8-4</u>	<u>23.8</u>	<u>23.8</u>	<u>23.8</u>	<u>DRY</u>
<u>8-5</u>	<u>24</u>	<u>24</u>	<u>23.5</u>	<u>DRY</u>
<u>8-6</u>	<u>24</u>	<u>24</u>	<u>24</u>	<u>DRY</u>
<u>8-7</u>	<u>24</u>	<u>24</u>	<u>24</u>	<u>LIGHT RAIN</u>
<u>8-8</u>	<u>24</u>	<u>24</u>	<u>24</u>	<u>DRY</u>

DATE _____

WELL NO.	WATER LEVEL (BELOW GRADE)	Ph	FLOW (GPH)	WELL NO.	WATER LEVEL (BELOW GRADE)
1B	<u>12'-11"</u>	<u>9.4</u>	<u>.04</u>	1	<u>14'-10"</u>
4	<u>12'-9"</u>	<u>4.5</u>	<u>1.51</u>	7	<u>16'-6"</u>
6	<u>18'-0"</u>	<u>8.9</u>	<u>.11</u>	8	<u>DRY</u>
2B	<u>DRY</u>			1A *	<u>5'-10"</u>

* BELOW FLOOR ELEVATION

NOTES: 8-4 CHANGED TUBING IN ALL WELLS
8-5 # 4 WELL NOT PUMPING. FLUSHED OUT LINES.
PUMP WORKING PROPERLY

WPL 005 5584

SET 0020623

WELL PUMPING & MONITORING LOG

WEEK OF

8-11-86

DATE	HOURS PUMPED			WEATHER COND. SUN. LIGHT TO MED. RAIN ALL DAY
	WELL #1B	WELL #6	WELL #4	
<u>8-11</u>	<u>23.8</u>	<u>23.8</u>	<u>23.8</u>	DRY
<u>8-12</u>	<u>24</u>	<u>24</u>	<u>24</u>	DRY
<u>8-13</u>	<u>24</u>	<u>24</u>	<u>24</u>	DRY
<u>8-14</u>	<u>24</u>	<u>23.8</u>	<u>24</u>	DRY
<u>8-15</u>	<u>24</u>	<u>24</u>	<u>24</u>	DRY

DATE _____

WELL NO.	WATER LEVEL (BELOW GRADE)	Ph	FLOW (GPH)	WELL NO.	WATER LEVEL (BELOW GRADE)
1B	<u>12'-11"</u>	<u>9.5</u>	<u>.03</u>	1	<u>15'-1"</u>
4	<u>12'-9"</u>	<u>3.9</u>	<u>2.35</u>	7	<u>16'-6"</u>
6	<u>18'-0"</u>	<u>8.8</u>	<u>.66</u>	8	<u>DRY</u>
2B	<u>DRY</u>			1A *	<u>5'-10"</u>

* BELOW FLOOR ELEVATION

NOTES: 8-11 REPAIRED TUBING IN WELL #1
8-12 REPAIRED TUBING IN WELL #4

SET 0020624

WELL PUMPING & MONITORING LOG

WEEK OF 8-18-86

DATE	HOURS PUMPED			WEATHER	COND.
	WELL #1B	WELL #6	WELL #4		
<u>8-18</u>	<u>23.8</u>	<u>23.8</u>	<u>23.8</u>	DRY	
<u>8-19</u>	<u>24</u>	<u>24</u>	<u>24</u>	DRY	
<u>8-20</u>	<u>24</u>	<u>24</u>	<u>24</u>	DRY	
<u>8-21</u>	<u>24</u>	<u>24</u>	<u>24</u>	DRY	
<u>8-22</u>	<u>24</u>	<u>24</u>	<u>24</u>	DRY	
_____	_____	_____	_____		
_____	_____	_____	_____		

DATE _____

WELL NO.	WATER LEVEL (BELOW GRADE)	Ph	FLOW (GPH)	WELL NO.	WATER LEVEL (BELOW GRADE)
1B	<u>12'-10"</u>	<u>9.5</u>	<u>4.01</u>	1	<u>14'-9"</u>
4	<u>12'-8"</u>	<u>4.5</u>	<u>1.32</u>	7	<u>16'-1"</u>
6	<u>17'-10"</u>	<u>8.9</u>	<u>.05</u>	8	<u>DRY</u>
2B	<u>DRY</u>			1A *	<u>5'-8"</u>

* BELOW FLOOR ELEVATION

NOTES: 8-18-86 - 24 HOURS PUMPING IN ALL WELLS

WELL PUMPING & MONITORING LOG

WEEK OF 8-25-86

DATE	HOURS PUMPED			WEATHER COND.
	WELL #1B	WELL #6	WELL #4	
<u>8-25</u>	<u>23.8</u>	<u>23.8</u>	<u>23.8</u>	DRY
<u>8-26</u>	<u>24</u>	<u>24</u>	<u>24</u>	LIGHT TO MED. RAIN
<u>8-27</u>	<u>24</u>	<u>24</u>	<u>24</u>	LIGHT RAIN
<u>8-28</u>	<u>24</u>	<u>24</u>	<u>24</u>	DRY
<u>8-29</u>	<u>24</u>	<u>24</u>	<u>24</u>	DRY

DATE _____

WELL NO.	WATER LEVEL (BELOW GRADE)	Ph	FLOW (GPH)	WELL NO.	WATER LEVEL (BELOW GRADE)
1B	<u>12'-8"</u>	<u>9.5</u>	<u>.04</u>	1	<u>14'-9"</u>
4	<u>12'-9"</u>	<u>4.1</u>	<u>1.73</u>	7	<u>15'-9"</u>
6	<u>18'-0"</u>	<u>8.8</u>	<u>.25</u>	8	<u>DRY</u>
2B	<u>DRY</u>			1A *	<u>5'-8"</u>

* BELOW FLOOR ELEVATION

NOTES: 8-25-86 CHANGED TUBING IN ALL WELLS

ANALYSIS REPORT



LANCY LABORATORIES
 Division, Lancy International, Inc.
 525 W. New Castle St., P.O. Box 480
 Zellenople, Pennsylvania 16063

An Alcoa Separations Technology Company

Westinghouse Electric Corp.
 One Tuscarawas Road
 Beaver, PA 15009

Attention: Mr. Ted Kasper

Report Date 10/6/86

Collected 8/28/86 by

Received 8/28/86 by LS

Analyzed 8/28 - 10/3/86 by Staff

No. of Samples 5

P.O. # 30-B-312100

Order Entry #26

Sample #	Well #	Lancy Reference #	Cyanide, Total (mg/L)
08-862801	1	21481	110
08-862802	1B	21482	1700
08-862803	6	21483	2.5
08-862804	7	21484	830
08-862805	4	21485	11

SET 0020627

 C. John Ritzert, Manager-Technical Services

WELL PUMPING & MONITORING LOG

WEEK OF 9-1-86

DATE	HOURS PUMPED			WEATHER COND.
	WELL #1B	WELL #6	WELL #4	
<u>9-1-86</u>	<u>HOLIDAY</u>			<u>DRY</u>
<u>9-2-86</u>	<u>23.8</u>	<u>23.8</u>	<u>23.8</u>	<u>DRY</u>
<u>9-3-86</u>	<u>24</u>	<u>24</u>	<u>24</u>	<u>DRY</u>
<u>9-4-86</u>	<u>24</u>	<u>24</u>	<u>0</u>	<u>DRY</u>
<u>9-5-86</u>	<u>24</u>	<u>24</u>	<u>0</u>	<u>DRY</u>
_____	_____	_____	_____	
_____	_____	_____	_____	

DATE _____

WELL NO.	WATER LEVEL (BELOW GRADE)	Ph	FLOW (GPH)	WELL NO.	WATER LEVEL (BELOW GRADE)
1B	_____	<u>9.7</u>	<u>.03</u>	1	_____
4	_____	_____	_____	7	_____
6	_____	<u>9.2</u>	<u>.05</u>	8	_____
2B	_____	_____	_____	1A *	_____

* BELOW FLOOR ELEVATION

NOTES: WELL #4 NOT PUMPING 9-4 9-5
NO WELL MEASUREMENTS TAKEN THIS WEEK

WELL PUMPING & MONITORING LOG

WEEK OF 9-15-86

DATE	HOURS PUMPED		
	WELL #1B	WELL #6	WELL #4
_____	_____	_____	_____
_____	_____	_____	_____
_____	_____	_____	_____
_____	_____	_____	_____
_____	_____	_____	_____
_____	_____	_____	_____
_____	_____	_____	_____

NO DATA

DATE _____

WELL NO.	WATER LEVEL (BELOW GRADE)	Ph	FLOW (GPH)	WELL NO.	WATER LEVEL (BELOW GRADE)
1B	_____	_____	_____	1	_____
4	_____	_____	_____	7	_____
6	_____	_____	_____	8	_____
2B	_____	_____	_____	1A *	_____

* BELOW FLOOR ELEVATION

NOTES: _____

WELL PUMPING & MONITORING LOG

WEEK OF SEPT. 8, 1986

DATE	HOURS PUMPED		WELL #4	WEATHER COND.
	WELL #1B	WELL #6		
<u>9-8-86</u>	<u>24</u>	<u>24</u>	<u>NOT PUMPING</u>	<u>DRY</u>
<u>9-9-86</u>	<u>24</u>	<u>24</u>	<u>NOT PUMPING</u>	<u>DRY</u>
<u>9-10-86</u>	<u>23.8</u>	<u>23.8</u>	<u>23.8</u>	<u>DRY</u>
<u>9-11-86</u>	<u>24</u>	<u>24</u>	<u>24</u>	<u>DRY</u>
<u>9-12-86</u>	<u>24</u>	<u>24</u>	<u>24</u>	<u>DRY</u>
_____	_____	_____	_____	_____
_____	_____	_____	_____	_____

DATE _____

WELL NO.	WATER LEVEL (BELOW GRADE)	Ph	FLOW (GPH)	WELL NO.	WATER LEVEL (BELOW GRADE)
1B	<u>DRY</u>	_____	_____	1	<u>15'-4"</u>
4	<u>12'-10"</u>	<u>4.1</u>	<u>2.0</u>	7	<u>15'-9"</u>
6	<u>DRY</u>	_____	_____	8	<u>DRY</u>
2B	<u>DRY</u>	_____	_____	1A *	<u>6'-5"</u>

* BELOW FLOOR ELEVATION

NOTES: 9-10-86 CHANGED TUBING IN ALL WELLS

WELL PUMPING & MONITORING LOG

WEEK OF

9-22-86

DATE	HOURS PUMPED			WEATHER COND
	WELL #18	WELL #6	WELL #4	
<u>9-22-86</u>	<u>18</u>	<u>18</u>	<u>18</u>	<u>RAIN</u>
<u>9-23</u>	<u>24</u>	<u>24</u>	<u>24</u>	<u>RAIN</u>
<u>9-24</u>	<u>24</u>	<u>24</u>	<u>24</u>	<u>RAIN</u>
<u>9-25</u>	<u>24</u>	<u>23.8</u>	<u>23.8</u>	<u>RAIN</u>
<u>9-26</u>	<u>24</u>	<u>24</u>	<u>24</u>	<u>DRY</u>
_____	_____	_____	_____	_____
_____	_____	_____	_____	_____

DATE _____

WELL NO.	WATER LEVEL (BELOW GRADE)	Ph	FLOW (GPH)	WELL NO.	WATER LEVEL (BELOW GRADE)
18	<u>12'-9"</u>	<u>9.0</u>	<u>.18</u>	1	<u>16'-10"</u>
4	<u>12'-1"</u>	<u>3.2</u>	<u>5.07</u>	7	<u>16'-10"</u>
6	<u>15'-1"</u>	<u>8.4</u>	<u>6.37</u>	8	<u>DRY</u>
28	<u>DRY</u>			1A *	<u>5'-9"</u>

* BELOW FLOOR ELEVATION

NOTES: 9-22-86 CHANGED TUBING IN ALL WELLS
9-25 CHANGED TUBING IN WELL #4 +
#6 WELL

WELL PUMPING & MONITORING LOG

WEEK OF 9-29-86

DATE	HOURS PUMPED			WEATHER COND.
	WELL #1B	WELL #6	WELL #4	
<u>9-29</u>	<u>23.8</u>	<u>24</u>	<u>23.8</u>	DRY
<u>9-30</u>	<u>24</u>	<u>23.8</u>	<u>24</u>	RAIN (EVENING)
<u>10-1</u>	<u>24</u>	<u>24</u>	<u>24</u>	RAIN
<u>10-2</u>	<u>24</u>	<u>23.8</u>	<u>24</u>	DRY
<u>10-3</u>	<u>24</u>	<u>24</u>	<u>24</u>	DRY
_____	_____	_____	_____	
_____	_____	_____	_____	

DATE _____

WELL NO.	WATER LEVEL (BELOW GRADE)	Ph	FLOW (GPH)	WELL NO.	WATER LEVEL (BELOW GRADE)
1B	<u>12'-10"</u>	<u>9.5</u>	<u>.14</u>	1	<u>15'-4"</u>
4	<u>12'-9"</u>	<u>3.1</u>	<u>7.06</u>	7	<u>15'-10"</u>
6	<u>14'-1"</u>	<u>8.4</u>	<u>8.78</u>	8	DRY
2B	<u>DRY</u>			1A *	<u>5'-5"</u>

* BELOW FLOOR ELEVATION

NOTES: 9-29
CHANGED TUBING IN WELLS # 1B & 4
9-30 CHANGED TUBING IN WELL # 6
10-2 CHANGED TUBING IN WELL # 6

ANALYSIS REPORT



LANCY LABORATORIES
 Division, Lancy International, Inc.
 525 W. New Castle St., P.O. Box 490
 Zellenople, Pennsylvania 16063

An Alcoa Separations Technology Company

Westinghouse Electric Corp.
 One Tuscarawas Road
 Beaver, PA 15009

Attention: Mr. Ted Kasper

Report Date 10/10/86

Collected 9/25/86 by WESBV

Received 9/29/86 by LS

Analyzed 9/29 - 10/6/86 by DB

No. of Samples 5

P.O. # 30-B-312100

Well Samples

Order Entry #26

Westinghouse Sample #	Well #	Lancy Reference #	Cyanide, Total (mg/L)
86-0925-01	1	22140	130
86-0925-02	1B	22141	550
86-0925-03	4	22142	3.9
86-0925-04	6	22143	0.99
86-0925-05	7	22144	905

SET 0020633

C. John Ritzert

C. John Ritzert, Manager-Technical Services

WELL PUMPING & MONITORING LOG

WEEK OF 10-6-86

DATE	HOURS PUMPED			WEATHER COND,
	WELL #1B	WELL #6	WELL #4	
<u>10-6</u>	<u>24</u>	<u>24</u>	<u>24</u>	<u>DRY</u>
<u>10-7</u>	<u>24</u>	<u>24</u>	<u>24</u>	<u>DRY</u>
<u>10-8</u>	<u>24</u>	<u>24</u>	<u>24</u>	<u>DRY</u>
<u>10-9</u>	<u>23.8</u>	<u>24</u>	<u>24</u>	<u>DRY</u>
<u>10-11</u>	<u>24</u>	<u>23.8</u>	<u>24</u>	<u>DRY</u>
_____	_____	_____	_____	
_____	_____	_____	_____	

DATE _____

WELL NO.	WATER LEVEL (BELOW GRADE)	Ph	FLOW (GPH)	WELL NO.	WATER LEVEL (BELOW GRADE)
1B	<u>12'-10"</u>	<u>9.2</u>	<u>.09</u>	1	<u>15'-4"</u>
4	<u>12'-9"</u>	<u>3.4</u>	<u>3.53</u>	7	<u>15'-10"</u>
6	<u>18'-1"</u>	<u>DRY</u>		8	<u>DRY</u>
2B	<u>DRY</u>			1A *	<u>5'-6"</u>

* BELOW FLOOR ELEVATION

NOTES: 10-9 CHANGED TUBING IN WELL #1B
10-10 CHANGED TUBING IN WELL #6

SET 0020634

WELL PUMPING & MONITORING LOG

WEEK OF 10-13-86

DATE	HOURS PUMPED			WEATHER COND.
	WELL #1B	WELL #6	WELL #4	
<u>10-13</u>	<u>24</u>	<u>24</u>	<u>24</u>	RAIN (LIGHT TO MED)
<u>10-14</u>	<u>24</u>	<u>23.8</u>	<u>23.8</u>	RAIN (" ")
<u>10-15</u>	<u>24</u>	<u>24</u>	<u>24</u>	DRY
<u>10-16</u>	<u>24</u>	<u>24</u>	<u>24</u>	DRY
<u>10-17</u>	<u>24</u>	<u>24</u>	<u>24</u>	DRY
_____	_____	_____	_____	
_____	_____	_____	_____	

DATE _____

WELL NO.	WATER LEVEL (BELOW GRADE)	Ph	FLOW (GPH)	WELL NO.	WATER LEVEL (BELOW GRADE)
1B	<u>12'-11"</u>	<u>9.2</u>	<u>.01</u>	1	<u>15'-6"</u>
4	<u>11'-7"</u>	<u>3.5</u>	<u>4.62</u>	7	<u>16'-5"</u>
6	<u>18'-2"</u>	<u>5.7</u>	<u>.20</u>	8	<u>39'-4"</u>
2B	<u>DRY</u>			1A *	<u>5'-5"</u>

* BELOW FLOOR ELEVATION

NOTES: 10-14 - CHANGED TUBING IN WELLS #4 & 6

WELL PUMPING & MONITORING LOG

WEEK OF 10-20-86

DATE	HOURS PUMPED			WEATHER COND.
	WELL #1B	WELL #6	WELL #4	
<u>10-20</u>	<u>23.8</u>	<u>23.8</u>	<u>23.8</u>	DRY
<u>10-21</u>	<u>24</u>	<u>24</u>	<u>24</u>	DRY
<u>10-22</u>	<u>24</u>	<u>24</u>	<u>24</u>	DRY
<u>10-23</u>	<u>24</u>	<u>24</u>	<u>24</u>	DRY
<u>10-24</u>	<u>24</u>	<u>24</u>	<u>24</u>	DRY
_____	_____	_____	_____	
_____	_____	_____	_____	

DATE _____

WELL NO.	WATER LEVEL (BELOW GRADE)	Ph	FLOW (GPH)	WELL NO.	WATER LEVEL (BELOW GRADE)
1B	<u>12'-10"</u>	<u>9.5</u>	<u>.01</u>	1	<u>15'-4"</u>
4	<u>12'-3"</u>	<u>4.0</u>	<u>6.0</u>	7	<u>15'-10"</u>
6	<u>18'-1"</u>	<u>8.8</u>	<u>.04</u>	8	<u>DRY</u>
2B	<u>DRY</u>			1A *	<u>5'-5"</u>

* BELOW FLOOR ELEVATION

NOTES: 10-20 CHANGED TUBING IN ALL WELLS

SET 0020636

WELL PUMPING & MONITORING LOG

WEEK OF 10-27-86

DATE	HOURS PUMPED			WEATHER COND.
	WELL #1B	WELL #6	WELL #4	
<u>10-27</u>	<u>24</u>	<u>24</u>	<u>24</u>	DRY
<u>10-28</u>	<u>24</u>	<u>24</u>	<u>24</u>	DRY
<u>10-29</u>	<u>23.8</u>	<u>23.8</u>	<u>24</u>	LIGHT RAIN
<u>10-30</u>	<u>24</u>	<u>24</u>	<u>24</u>	" "
<u>10-31</u>	<u>24</u>	<u>24</u>	<u>23.8</u>	DRY
_____	_____	_____	_____	
_____	_____	_____	_____	

DATE _____

WELL NO.	WATER LEVEL (BELOW GRADE)	Ph	FLOW (GPH)	WELL NO.	WATER LEVEL (BELOW GRADE)
1B	<u>13'-0"</u>	<u>9.5</u>	<u><.01</u>	1	<u>15'-11"</u>
4	<u>12'-1"</u>	<u>3.4</u>	<u>1.76</u>	7	<u>16'-10</u>
6	<u>18'-2"</u>	<u>8.9</u>	<u>.01</u>	8	<u>DRY</u>
2B	<u>DRY</u>			1A *	<u>5'-11"</u>

* BELOW FLOOR ELEVATION

NOTES: 10-29 CHANGED TUBING IN WELL # 6 & 1B
10-30 REPLACED TUBING IN WELL # 4

WPL 005 5598

SET 0020637