



**COMMONWEALTH OF PENNSYLVANIA
DEPARTMENT OF ENVIRONMENTAL PROTECTION
AIR QUALITY PROGRAM**

PLAN APPROVAL

Issue Date:

Effective Date:

Expiration Date:

In accordance with the provisions of the Air Pollution Control Act, the Act of January 8, 1960, P.L. 2119, as amended, and 25 Pa. Code Chapter 127, the Owner, [and Operator if noted] (hereinafter referred to as permittee) identified below is authorized by the Department of Environmental Protection (Department) to construct, install, modify or reactivate the air emission source(s) more fully described in the site inventory list. This Facility is subject to all terms and conditions specified in this plan approval. Nothing in this plan approval relieves the permittee from its obligations to comply with all applicable Federal, State and Local laws and regulations.

The regulatory or statutory authority for each plan approval condition is set forth in brackets. All terms and conditions in this permit are federally enforceable unless otherwise designated as "State-Only" requirements.

Plan Approval No. 23-0004B

Federal Tax Id - Plant Code: 76-0531017-1

Owner Information

Name: COVANTA DELAWARE VALLEY LP
Mailing Address: 10 HIGHLAND AVE
CHESTER, PA 19013-2231

Plant Information

Plant: COVANTA DELAWARE VALLEY LP/DELAWARE VALLEY RES REC
Location: 23 Delaware County 23001 Chester City
SIC Code: 4953 Trans. & Utilities - Refuse Systems

Responsible Official

Name: LARRY SMITH
Title: FACILITY MGR
Phone: (610) 497 - 8100 Email: lsmith2@covanta.com

Plan Approval Contact Person

Name: ALEXANDRA(ALLIE) JOZWIK
Title: ENV COMPLIANCE SPECIALIST
Phone: (610) 497 - 8100 Email: ajozwik@covanta.com

[Signature] _____
JAMES D. REBARCHAK, SOUTHEAST REGION AIR PROGRAM MANAGER



Plan Approval Description

A plan approval for the installation and operation of SNCR on each of the six (6) municipal waste combustors (Sources 101, 102, 103, 104, 105, & 106) to control NOx emissions to below the presumptive RACT III limit.

**SECTION A. Table of Contents****Section A. Facility/Source Identification**

Table of Contents
Plan Approval Inventory List

Section B. General Plan Approval Requirements

- #001 Definitions
- #002 Future Adoption of Requirements
- #003 Plan Approval Temporary Operation
- #004 Content of Applications
- #005 Public Records and Confidential Information
- #006 Plan Approval terms and conditions.
- #007 Transfer of Plan Approvals
- #008 Inspection and Entry
- #009 Plan Approval Changes for Cause
- #010 Circumvention
- #011 Submissions
- #012 Risk Management
- #013 Compliance Requirement

Section C. Site Level Plan Approval Requirements

- C-I: Restrictions
- C-II: Testing Requirements
- C-III: Monitoring Requirements
- C-IV: Recordkeeping Requirements
- C-V: Reporting Requirements
- C-VI: Work Practice Standards
- C-VII: Additional Requirements
- C-VIII: Compliance Certification
- C-IX: Compliance Schedule

Section D. Source Level Plan Approval Requirements

- D-I: Restrictions
- D-II: Testing Requirements
- D-III: Monitoring Requirements
- D-IV: Recordkeeping Requirements
- D-V: Reporting Requirements
- D-VI: Work Practice Standards
- D-VII: Additional Requirements

Note: These same sub-sections are repeated for each source!

Section E. Source Group Restrictions

- E-I: Restrictions
- E-II: Testing Requirements
- E-III: Monitoring Requirements
- E-IV: Recordkeeping Requirements
- E-V: Reporting Requirements
- E-VI: Work Practice Standards
- E-VII: Additional Requirements

Section F. Alternative Operating Scenario(s)

- F-I: Restrictions
- F-II: Testing Requirements
- F-III: Monitoring Requirements



SECTION A. Table of Contents

- F-IV: Recordkeeping Requirements
- F-V: Reporting Requirements
- F-VI: Work Practice Standards
- F-VII: Additional Requirements

Section G. Emission Restriction Summary

Section H. Miscellaneous

**SECTION A. Plan Approval Inventory List**

Source ID	Source Name	Capacity/Throughput	Fuel/Material
101	ROTARY COMBUSTER 1		
102	ROTARY COMBUSTER 2		
103	ROTARY COMBUSTER 3		
104	ROTARY COMBUSTER 4		
105	ROTARY COMBUSTER 5		
106	ROTARY COMBUSTER 6		
C01A	BAGHOUSE - PULSE JET FABRIC FILTER		
C02	SPRAY DRYER ABSORBER		
C03	BAGHOUSE - PULSE JET FABRIC FILTER		
C04	SPRAY DRYER ABSORBER		
C05	BAGHOUSE - PULSE JET FABRIC FILTER		
C06	SPRAY DRYER ABSORBER		
C07	BAGHOUSE - PULSE JET FABRIC FILTER		
C08	SPRAY DRYER ABSORBER		
C09	BAGHOUSE - PULSE JET FABRIC FILTER		
C10	SPRAY DRYER ABSORBER		
C11	BAGHOUSE - PULSE JET FABRIC FILTER		
C12	SPRAY DRYER ABSORBER		
C13	SNCR SYSTEM 1		
C14	SNCR SYSTEM 2		
C15	SNCR SYSTEM 3		
C16	SNCR SYSTEM 4		
C17	SNCR SYSTEM 5		
C18	SNCR SYSTEM 6		
FML01	NATURAL GAS PIPELINE		
FML02	MUNICIPAL WASTE STORAGE PIT		
S01	COMBUSTOR 1 STACK		
S02	COMBUSTOR 2 STACK		
S03	COMBUSTOR 3 STACK		
S04	COMBUSTOR 4 STACK		
S05	COMBUSTOR 5 STACK		
S06	COMBUSTOR 6 STACK		

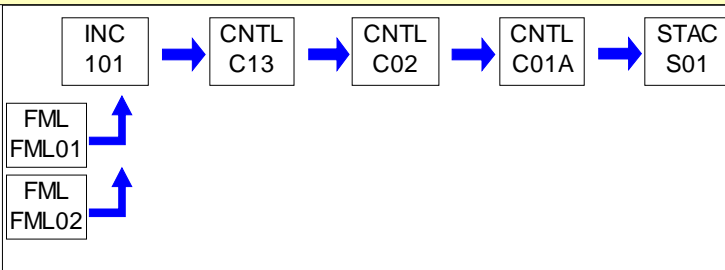
PERMIT MAPS



PERMIT MAPS

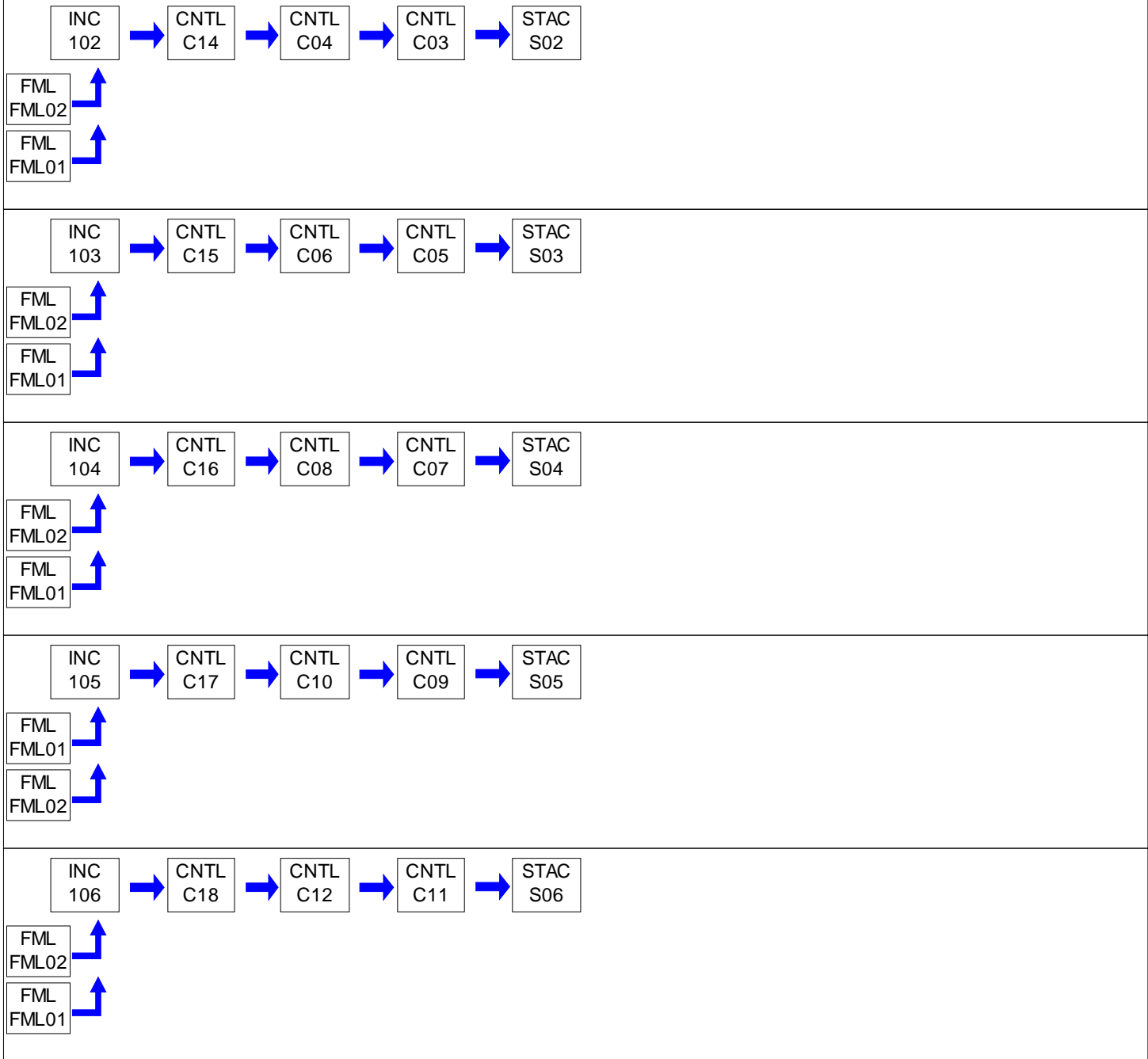

**SECTION B. General Plan Approval Requirements****#001 [25 Pa. Code § 121.1]****Definitions**

Words and terms that are not otherwise defined in this plan approval shall have the meanings set forth in Section 3 of the Air Pollution Control Act (35 P.S. § 4003) and 25 Pa. Code § 121.1.

#002 [25 Pa. Code § 127.12b (a) (b)]**Future Adoption of Requirements**

The issuance of this plan approval does not prevent the future adoption by the Department of any rules, regulations or standards, or the issuance of orders necessary to comply with the requirements of the Federal Clean Air Act or the Pennsylvania Air Pollution Control Act, or to achieve or maintain ambient air quality standards. The issuance of this plan approval shall not be construed to limit the Department's enforcement authority.

#003 [25 Pa. Code § 127.12b]**Plan Approval Temporary Operation**

This plan approval authorizes temporary operation of the source(s) covered by this plan approval provided the following conditions are met.

(a) When construction, installation, modification, or reactivation is being conducted, the permittee shall provide written notice to the Department of the completion of the activity approved by this plan approval and the permittee's intent to commence operation at least five (5) working days prior to the completion of said activity. The notice shall state when the activity will be completed and when the permittee expects to commence operation. When the activity involves multiple sources on different time schedules, notice is required for the commencement of operation of each source.

(b) Pursuant to 25 Pa. Code § 127.12b (d), temporary operation of the source(s) is authorized to facilitate the shakedown of sources and air cleaning devices, to permit operations pending the issuance of a permit under 25 Pa. Code Chapter 127, Subchapter F (relating to operating permits) or Subchapter G (relating to Title V operating permits) or to permit the evaluation of the air contaminant aspects of the source.

(c) This plan approval authorizes a temporary operation period not to exceed 180 days from the date of commencement of operation, provided the Department receives notice from the permittee pursuant to paragraph (a), above.

(d) The permittee may request an extension of the 180-day shakedown period if further evaluation of the air contamination aspects of the source(s) is necessary. The request for an extension shall be submitted, in writing, to the Department at least 15 days prior to the end of the initial 180-day shakedown period and shall provide a description of the compliance status of the source, a detailed schedule for establishing compliance, and the reasons compliance has not been established. This temporary operation period will be valid for a limited time and may be extended for additional limited periods, each not to exceed 180 days.

(e) The notice submitted by the permittee pursuant to subpart (a) above, prior to the expiration of the plan approval, shall modify the plan approval expiration date on Page 1 of this plan approval. The new plan approval expiration date shall be 180 days from the date of commencement of operation.

#004 [25 Pa. Code § 127.12(a) (10)]**Content of Applications**

The permittee shall maintain and operate the sources and associated air cleaning devices in accordance with good engineering practice as described in the plan approval application submitted to the Department.

#005 [25 Pa. Code §§ 127.12(c) and (d) & 35 P.S. § 4013.2]**Public Records and Confidential Information**

(a) The records, reports or information obtained by the Department or referred to at public hearings shall be available to the public, except as provided in paragraph (b) of this condition.

(b) Upon cause shown by the permittee that the records, reports or information, or a particular portion thereof, but not emission data, to which the Department has access under the act, if made public, would divulge production or sales figures or methods, processes or production unique to that person or would otherwise tend to affect adversely the

**SECTION B. General Plan Approval Requirements**

competitive position of that person by revealing trade secrets, including intellectual property rights, the Department will consider the record, report or information, or particular portion thereof confidential in the administration of the act. The Department will implement this section consistent with sections 112(d) and 114(c) of the Clean Air Act (42 U.S.C.A. § § 7412(d) and 7414(c)). Nothing in this section prevents disclosure of the report, record or information to Federal, State or local representatives as necessary for purposes of administration of Federal, State or local air pollution control laws, or when relevant in a proceeding under the act.

#006 [25 Pa. Code § 127.12b]**Plan Approval terms and conditions.**

[Additional authority for this condition is derived from 25 Pa. Code Section 127.13]

(a) This plan approval will be valid for a limited time, as specified by the expiration date contained on Page 1 of this plan approval. Except as provided in § § 127.11a and 127.215 (relating to reactivation of sources; and reactivation), at the end of the time, if the construction, modification, reactivation or installation has not been completed, a new plan approval application or an extension of the previous approval will be required.

(b) If construction has commenced, but cannot be completed before the expiration of this plan approval, an extension of the plan approval must be obtained to continue construction. To allow adequate time for departmental action, a request for the extension shall be postmarked at least thirty (30) days prior to the expiration date. The request for an extension shall include the following:

- (i) A justification for the extension,
- (ii) A schedule for the completion of the construction

If construction has not commenced before the expiration of this plan approval, then a new plan approval application must be submitted and approval obtained before construction can commence.

(c) If the construction, modification or installation is not commenced within 18 months of the issuance of this plan approval or if there is more than an 18-month lapse in construction, modification or installation, a new plan approval application that meets the requirements of 25 Pa. Code Chapter 127, Subchapter B (related to plan approval requirements), Subchapter D (related to prevention of significant deterioration of air quality), and Subchapter E (related to new source review) shall be submitted. The Department may extend the 18-month period upon a satisfactory showing that an extension is justified.

#007 [25 Pa. Code § 127.32]**Transfer of Plan Approvals**

(a) This plan approval may not be transferred from one person to another except when a change of ownership is demonstrated to the satisfaction of the Department and the Department approves the transfer of the plan approval in writing.

(b) Section 127.12a (relating to compliance review) applies to a request for transfer of a plan approval. A compliance review form shall accompany the request.

(c) This plan approval is valid only for the specific source and the specific location of the source as described in the application.

#008 [25 Pa. Code § 127.12(4) & 35 P.S. § 4008 & § 114 of the CAA]**Inspection and Entry**

(a) Pursuant to 35 P.S. § 4008, no person shall hinder, obstruct, prevent or interfere with the Department or its personnel in the performance of any duty authorized under the Air Pollution Control Act.

(b) The permittee shall also allow the Department to have access at reasonable times to said sources and associated air cleaning devices with such measuring and recording equipment, including equipment recording visual observations, as the Department deems necessary and proper for performing its duties and for the effective enforcement of the Air Pollution Control Act and regulations adopted under the act.

**SECTION B. General Plan Approval Requirements**

(c) Nothing in this plan approval condition shall limit the ability of the Environmental Protection Agency to inspect or enter the premises of the permittee in accordance with Section 114 or other applicable provisions of the Clean Air Act.

#009 [25 Pa. Code 127.13a]**Plan Approval Changes for Cause**

This plan approval may be terminated, modified, suspended or revoked and reissued if one or more of the following applies:

- (a) The permittee constructs or operates the source subject to the plan approval in violation of the act, the Clean Air Act, the regulations promulgated under the act or the Clean Air Act, a plan approval or permit or in a manner that causes air pollution.
- (b) The permittee fails to properly or adequately maintain or repair an air pollution control device or equipment attached to or otherwise made a part of the source.
- (c) The permittee fails to submit a report required by this plan approval.
- (d) The Environmental Protection Agency determines that this plan approval is not in compliance with the Clean Air Act or the regulations thereunder.

#010 [25 Pa. Code §§ 121.9 & 127.216]**Circumvention**

- (a) The permittee, or any other person, may not circumvent the new source review requirements of 25 Pa. Code Chapter 127, Subchapter E by causing or allowing a pattern of ownership or development, including the phasing, staging, delaying or engaging in incremental construction, over a geographic area of a facility which, except for the pattern of ownership or development, would otherwise require a permit or submission of a plan approval application.
- (b) No person may permit the use of a device, stack height which exceeds good engineering practice stack height, dispersion technique or other technique which, without resulting in reduction of the total amount of air contaminants emitted, conceals or dilutes an emission of air contaminants which would otherwise be in violation of this plan approval, the Air Pollution Control Act or the regulations promulgated thereunder, except that with prior approval of the Department, the device or technique may be used for control of malodors.

#011 [25 Pa. Code § 127.12c]**Submissions**

Reports, test data, monitoring data, notifications shall be submitted to the:

Regional Air Program Manager
PA Department of Environmental Protection
(At the address given on the plan approval transmittal letter or otherwise notified)

#012 [25 Pa. Code § 127.12(9) & 40 CFR Part 68]**Risk Management**

(a) If required by Section 112(r) of the Clean Air Act, the permittee shall develop and implement an accidental release program consistent with requirements of the Clean Air Act, 40 CFR Part 68 (relating to chemical accident prevention provisions) and the Federal Chemical Safety Information, Site Security and Fuels Regulatory Relief Act (P.L. 106-40).

(b) The permittee shall prepare and implement a Risk Management Plan (RMP) which meets the requirements of Section 112(r) of the Clean Air Act, 40 CFR Part 68 and the Federal Chemical Safety Information, Site Security and Fuels Regulatory Relief Act when a regulated substance listed in 40 CFR § 68.130 is present in a process in more than the listed threshold quantity at the facility. The permittee shall submit the RMP to the Environmental Protection Agency according to the following schedule and requirements:

(1) The permittee shall submit the first RMP to a central point specified by the Environmental Protection Agency no later than the latest of the following:



SECTION B. General Plan Approval Requirements

- (i) Three years after the date on which a regulated substance is first listed under § 68.130; or,
- (ii) The date on which a regulated substance is first present above a threshold quantity in a process.

(2) The permittee shall submit any additional relevant information requested by the Department or the Environmental Protection Agency concerning the RMP and shall make subsequent submissions of RMPs in accordance with 40 CFR § 68.190.

(3) The permittee shall certify that the RMP is accurate and complete in accordance with the requirements of 40 CFR Part 68, including a checklist addressing the required elements of a complete RMP.

(c) As used in this plan approval condition, the term "process" shall be as defined in 40 CFR § 68.3. The term "process" means any activity involving a regulated substance including any use, storage, manufacturing, handling, or on-site movement of such substances or any combination of these activities. For purposes of this definition, any group of vessels that are interconnected, or separate vessels that are located such that a regulated substance could be involved in a potential release, shall be considered a single process.

#013 [25 Pa. Code § 127.25]

Compliance Requirement

A person may not cause or permit the operation of a source subject to § 127.11 (relating to plan approval requirements), unless the source and air cleaning devices identified in the application for the plan approval and the plan approval issued to the source, are operated and maintained in accordance with specifications in the application and conditions in the plan approval issued by the Department. A person may not cause or permit the operation of an air contamination source subject to this chapter in a manner inconsistent with good operating practices.



SECTION C. Site Level Plan Approval Requirements

I. RESTRICTIONS.

No additional requirements exist except as provided in other sections of this plan approval including Section B (Plan Approval General Requirements).

II. TESTING REQUIREMENTS.

No additional testing requirements exist except as provided in other sections of this plan approval including Section B (Plan Approval General Requirements).

III. MONITORING REQUIREMENTS.

No additional monitoring requirements exist except as provided in other sections of this plan approval including Section B (Plan Approval General Requirements).

IV. RECORDKEEPING REQUIREMENTS.

No additional record keeping requirements exist except as provided in other sections of this plan approval including Section B (Plan Approval General Requirements).

V. REPORTING REQUIREMENTS.

No additional reporting requirements exist except as provided in other sections of this plan approval including Section B (Plan Approval General Requirements).

VI. WORK PRACTICE REQUIREMENTS.

No additional work practice requirements exist except as provided in other sections of this plan approval including Section B (Plan Approval General Requirements).

VII. ADDITIONAL REQUIREMENTS.

001 [25 Pa. Code §127.12b]

Plan approval terms and conditions.

The permittee shall comply with all of the existing requirements of their current Operating Permit, No. 23-00004, except the requirements specified in this plan approval. The provisions in this plan approval shall supersede any contrary provisions in any previous plan approvals and operating permit.

VIII. COMPLIANCE CERTIFICATION.

No additional compliance certifications exist except as provided in other sections of this plan approval including Section B (relating to Plan Approval General Requirements).

IX. COMPLIANCE SCHEDULE.

No compliance milestones exist.

**SECTION D. Source Level Plan Approval Requirements**

Source ID: 101

Source Name: ROTARY COMBUSTER 1

Source Capacity/Throughput:

Conditions for this source occur in the following groups: GROUP 2

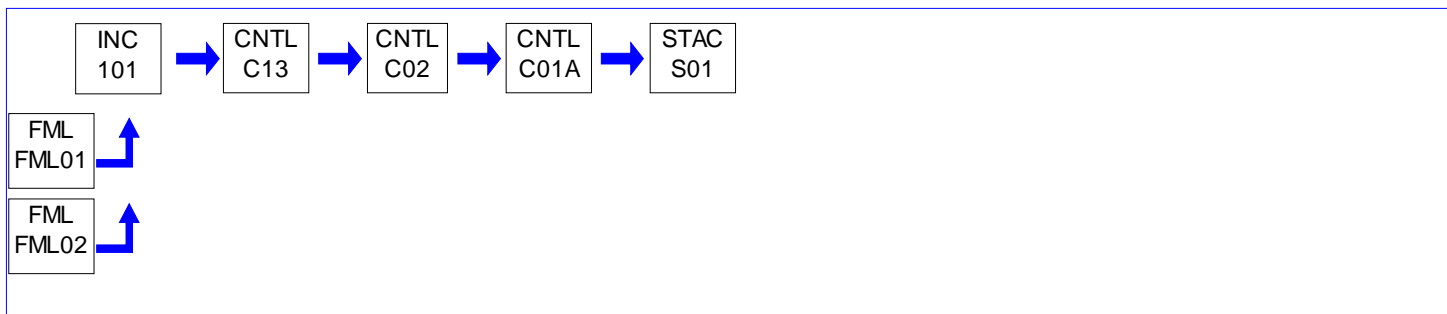
**I. RESTRICTIONS.**

No additional requirements exist except as provided in other sections of this plan approval including Section B (Plan Approval General Requirements) and/or Section E (Source Group Restrictions).

II. TESTING REQUIREMENTS.

No additional testing requirements exist except as provided in other sections of this plan approval including Section B (Plan Approval General Requirements) and/or Section E (Source Group Restrictions).

III. MONITORING REQUIREMENTS.

No additional monitoring requirements exist except as provided in other sections of this plan approval including Section B (Plan Approval General Requirements) and/or Section E (Source Group Restrictions).

IV. RECORDKEEPING REQUIREMENTS.

No additional record keeping requirements exist except as provided in other sections of this plan approval including Section B (Plan Approval General Requirements) and/or Section E (Source Group Restrictions).

V. REPORTING REQUIREMENTS.

No additional reporting requirements exist except as provided in other sections of this plan approval including Section B (Plan Approval General Requirements) and/or Section E (Source Group Restrictions).

VI. WORK PRACTICE REQUIREMENTS.

No additional work practice requirements exist except as provided in other sections of this plan approval including Section B (Plan Approval General Requirements) and/or Section E (Source Group Restrictions).

VII. ADDITIONAL REQUIREMENTS.

No additional requirements exist except as provided in other sections of this plan approval including Section B (Plan Approval General Requirements) and/or Section E (Source Group Restrictions).

**SECTION D. Source Level Plan Approval Requirements**

Source ID: 102

Source Name: ROTARY COMBUSTER 2

Source Capacity/Throughput:

Conditions for this source occur in the following groups: GROUP 2

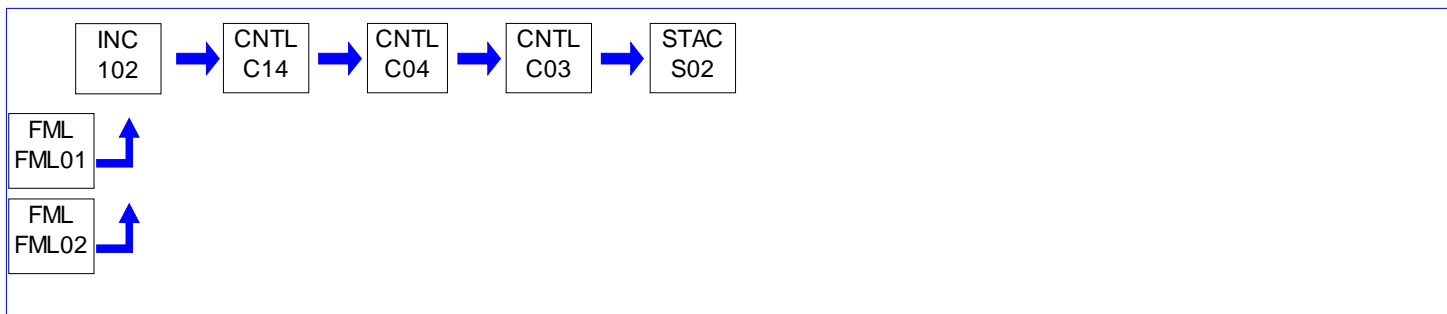
**I. RESTRICTIONS.**

No additional requirements exist except as provided in other sections of this plan approval including Section B (Plan Approval General Requirements) and/or Section E (Source Group Restrictions).

II. TESTING REQUIREMENTS.

No additional testing requirements exist except as provided in other sections of this plan approval including Section B (Plan Approval General Requirements) and/or Section E (Source Group Restrictions).

III. MONITORING REQUIREMENTS.

No additional monitoring requirements exist except as provided in other sections of this plan approval including Section B (Plan Approval General Requirements) and/or Section E (Source Group Restrictions).

IV. RECORDKEEPING REQUIREMENTS.

No additional record keeping requirements exist except as provided in other sections of this plan approval including Section B (Plan Approval General Requirements) and/or Section E (Source Group Restrictions).

V. REPORTING REQUIREMENTS.

No additional reporting requirements exist except as provided in other sections of this plan approval including Section B (Plan Approval General Requirements) and/or Section E (Source Group Restrictions).

VI. WORK PRACTICE REQUIREMENTS.

No additional work practice requirements exist except as provided in other sections of this plan approval including Section B (Plan Approval General Requirements) and/or Section E (Source Group Restrictions).

VII. ADDITIONAL REQUIREMENTS.

No additional requirements exist except as provided in other sections of this plan approval including Section B (Plan Approval General Requirements) and/or Section E (Source Group Restrictions).



SECTION D. Source Level Plan Approval Requirements

Source ID: 103

Source Name: ROTARY COMBUSTER 3

Source Capacity/Throughput:

Conditions for this source occur in the following groups: GROUP 2

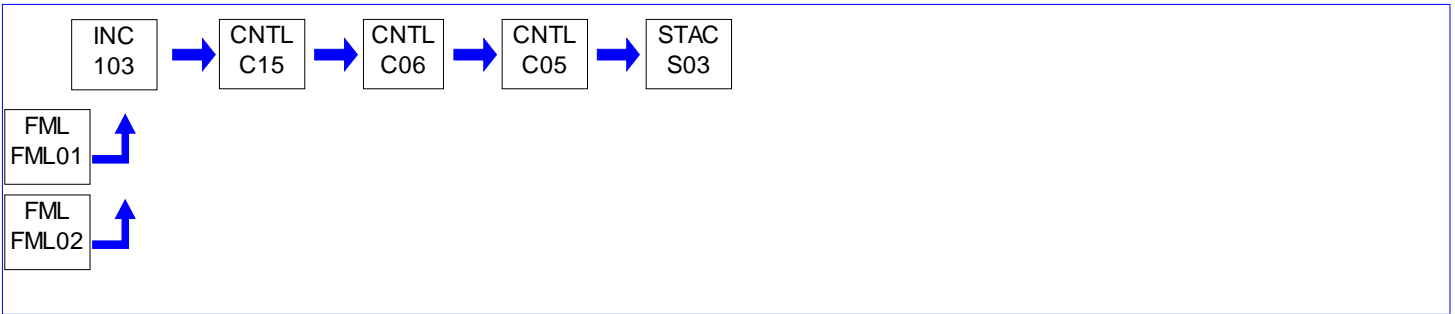

I. RESTRICTIONS.

No additional requirements exist except as provided in other sections of this plan approval including Section B (Plan Approval General Requirements) and/or Section E (Source Group Restrictions).

II. TESTING REQUIREMENTS.

No additional testing requirements exist except as provided in other sections of this plan approval including Section B (Plan Approval General Requirements) and/or Section E (Source Group Restrictions).

III. MONITORING REQUIREMENTS.

No additional monitoring requirements exist except as provided in other sections of this plan approval including Section B (Plan Approval General Requirements) and/or Section E (Source Group Restrictions).

IV. RECORDKEEPING REQUIREMENTS.

No additional record keeping requirements exist except as provided in other sections of this plan approval including Section B (Plan Approval General Requirements) and/or Section E (Source Group Restrictions).

V. REPORTING REQUIREMENTS.

No additional reporting requirements exist except as provided in other sections of this plan approval including Section B (Plan Approval General Requirements) and/or Section E (Source Group Restrictions).

VI. WORK PRACTICE REQUIREMENTS.

No additional work practice requirements exist except as provided in other sections of this plan approval including Section B (Plan Approval General Requirements) and/or Section E (Source Group Restrictions).

VII. ADDITIONAL REQUIREMENTS.

No additional requirements exist except as provided in other sections of this plan approval including Section B (Plan Approval General Requirements) and/or Section E (Source Group Restrictions).

**SECTION D. Source Level Plan Approval Requirements**

Source ID: 104

Source Name: ROTARY COMBUSTER 4

Source Capacity/Throughput:

Conditions for this source occur in the following groups: GROUP 2

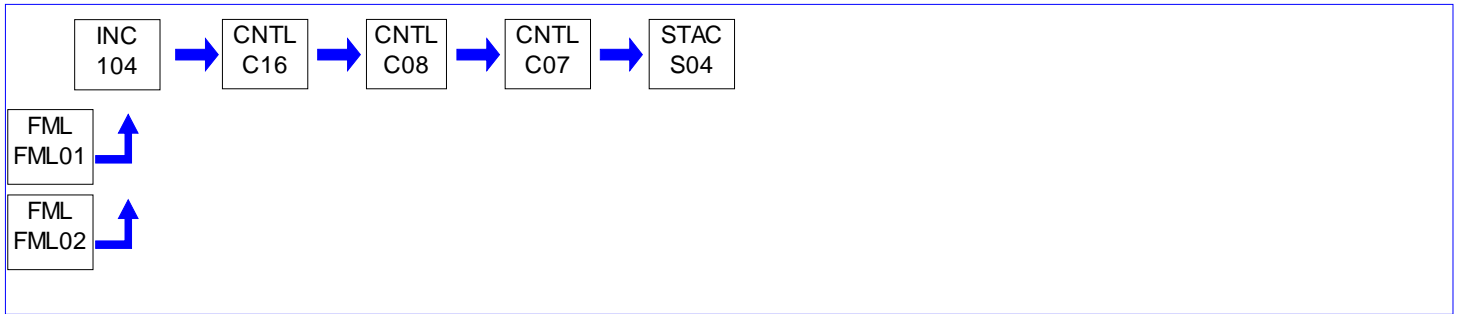
**I. RESTRICTIONS.**

No additional requirements exist except as provided in other sections of this plan approval including Section B (Plan Approval General Requirements) and/or Section E (Source Group Restrictions).

II. TESTING REQUIREMENTS.

No additional testing requirements exist except as provided in other sections of this plan approval including Section B (Plan Approval General Requirements) and/or Section E (Source Group Restrictions).

III. MONITORING REQUIREMENTS.

No additional monitoring requirements exist except as provided in other sections of this plan approval including Section B (Plan Approval General Requirements) and/or Section E (Source Group Restrictions).

IV. RECORDKEEPING REQUIREMENTS.

No additional record keeping requirements exist except as provided in other sections of this plan approval including Section B (Plan Approval General Requirements) and/or Section E (Source Group Restrictions).

V. REPORTING REQUIREMENTS.

No additional reporting requirements exist except as provided in other sections of this plan approval including Section B (Plan Approval General Requirements) and/or Section E (Source Group Restrictions).

VI. WORK PRACTICE REQUIREMENTS.

No additional work practice requirements exist except as provided in other sections of this plan approval including Section B (Plan Approval General Requirements) and/or Section E (Source Group Restrictions).

VII. ADDITIONAL REQUIREMENTS.

No additional requirements exist except as provided in other sections of this plan approval including Section B (Plan Approval General Requirements) and/or Section E (Source Group Restrictions).

**SECTION D. Source Level Plan Approval Requirements**

Source ID: 105

Source Name: ROTARY COMBUSTER 5

Source Capacity/Throughput:

Conditions for this source occur in the following groups: GROUP 2

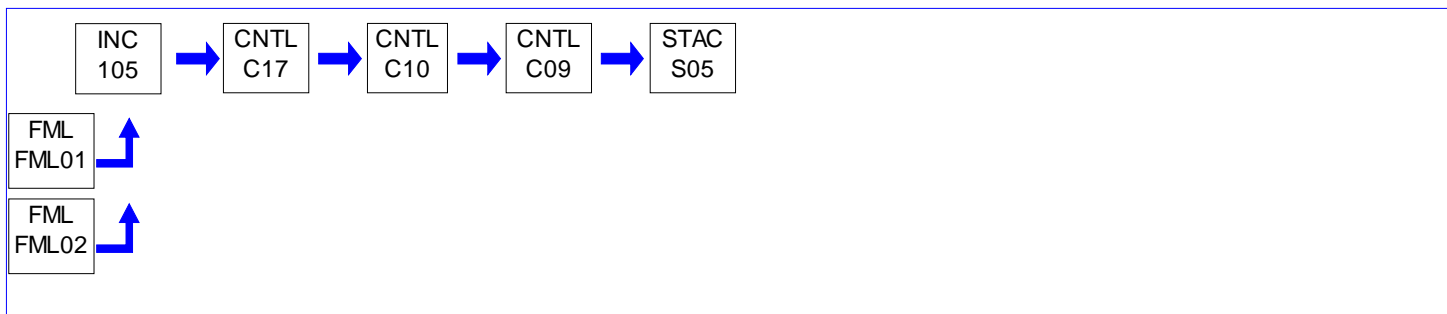
**I. RESTRICTIONS.**

No additional requirements exist except as provided in other sections of this plan approval including Section B (Plan Approval General Requirements) and/or Section E (Source Group Restrictions).

II. TESTING REQUIREMENTS.

No additional testing requirements exist except as provided in other sections of this plan approval including Section B (Plan Approval General Requirements) and/or Section E (Source Group Restrictions).

III. MONITORING REQUIREMENTS.

No additional monitoring requirements exist except as provided in other sections of this plan approval including Section B (Plan Approval General Requirements) and/or Section E (Source Group Restrictions).

IV. RECORDKEEPING REQUIREMENTS.

No additional record keeping requirements exist except as provided in other sections of this plan approval including Section B (Plan Approval General Requirements) and/or Section E (Source Group Restrictions).

V. REPORTING REQUIREMENTS.

No additional reporting requirements exist except as provided in other sections of this plan approval including Section B (Plan Approval General Requirements) and/or Section E (Source Group Restrictions).

VI. WORK PRACTICE REQUIREMENTS.

No additional work practice requirements exist except as provided in other sections of this plan approval including Section B (Plan Approval General Requirements) and/or Section E (Source Group Restrictions).

VII. ADDITIONAL REQUIREMENTS.

No additional requirements exist except as provided in other sections of this plan approval including Section B (Plan Approval General Requirements) and/or Section E (Source Group Restrictions).

**SECTION D. Source Level Plan Approval Requirements**

Source ID: 106

Source Name: ROTARY COMBUSTER 6

Source Capacity/Throughput:

Conditions for this source occur in the following groups: GROUP 2

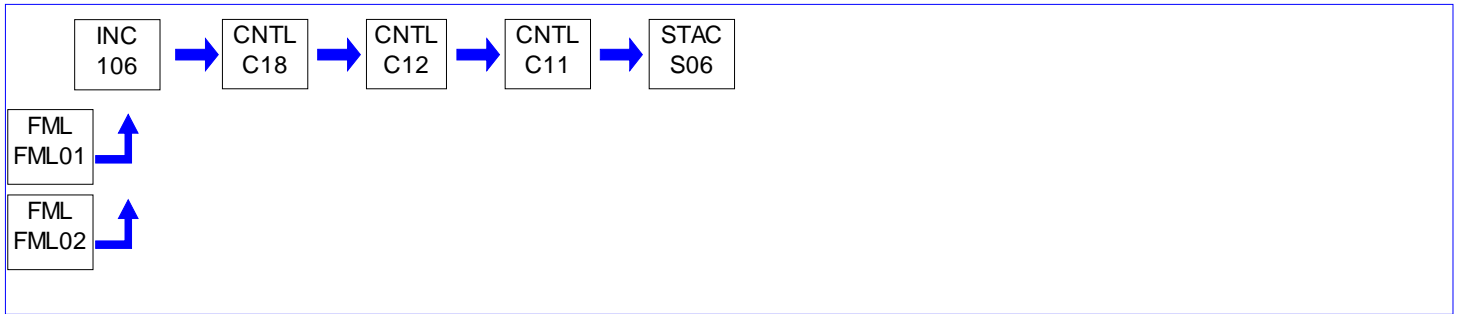
**I. RESTRICTIONS.**

No additional requirements exist except as provided in other sections of this plan approval including Section B (Plan Approval General Requirements) and/or Section E (Source Group Restrictions).

II. TESTING REQUIREMENTS.

No additional testing requirements exist except as provided in other sections of this plan approval including Section B (Plan Approval General Requirements) and/or Section E (Source Group Restrictions).

III. MONITORING REQUIREMENTS.

No additional monitoring requirements exist except as provided in other sections of this plan approval including Section B (Plan Approval General Requirements) and/or Section E (Source Group Restrictions).

IV. RECORDKEEPING REQUIREMENTS.

No additional record keeping requirements exist except as provided in other sections of this plan approval including Section B (Plan Approval General Requirements) and/or Section E (Source Group Restrictions).

V. REPORTING REQUIREMENTS.

No additional reporting requirements exist except as provided in other sections of this plan approval including Section B (Plan Approval General Requirements) and/or Section E (Source Group Restrictions).

VI. WORK PRACTICE REQUIREMENTS.

No additional work practice requirements exist except as provided in other sections of this plan approval including Section B (Plan Approval General Requirements) and/or Section E (Source Group Restrictions).

VII. ADDITIONAL REQUIREMENTS.

No additional requirements exist except as provided in other sections of this plan approval including Section B (Plan Approval General Requirements) and/or Section E (Source Group Restrictions).

**SECTION E. Source Group Plan Approval Restrictions.**

Group Name: GROUP 2

Group Description: Requirements for SNCR

Sources included in this group

ID	Name
101	ROTARY COMBUSTER 1
102	ROTARY COMBUSTER 2
103	ROTARY COMBUSTER 3
104	ROTARY COMBUSTER 4
105	ROTARY COMBUSTER 5
106	ROTARY COMBUSTER 6

I. RESTRICTIONS.**Emission Restriction(s).****# 001 [25 Pa. Code §127.12b]****Plan approval terms and conditions.**

The ammonia slip concentration from the aqueous ammonia Selective Non-Catalytic Reduction (SNCR) system shall not exceed 5 ppm_{dv}, corrected to 7% oxygen.

Compliance with the ammonia slip emission limit is based on the average concentration of three (3) consecutive stack testing runs.

[Compliance with the above ammonia limit assures compliance with the Department's BAT standards.]

002 [25 Pa. Code §127.12b]**Plan approval terms and conditions.**

Nitrogen Oxides (NO_x) emissions from each of the municipal waste combustors, expressed as NO₂, shall not exceed any of the following:

(a) 110 ppm_{dv}, corrected to 7% oxygen, daily average using the Department approved Continuous Emission Monitoring System (CEMS)

[Additional authority for this permit condition is also derived from 25 Pa. Code §§ 129.112(f) and 129.115(b)(3).

Compliance with this NO_x limit assures compliance with the Department's BAT standards, 25 Pa. Code §§ 129.97(f) and 129.100(a)(3).];

(b) 88.56 lbs/hr; and

(c) 0.42 lbs/MMBtu.

The NO_x emission limit in ppm_{dv} unit applies at all times when municipal wastes are incinerated, including during periods of start-up, shut-down, and malfunction.

Control Device Efficiency Restriction(s).**# 003 [25 Pa. Code §127.12b]****Plan approval terms and conditions.**

Air contaminant emissions from each of the combustors shall be controlled by its associated Selective Non-Catalytic Reduction (SNCR) system for NO_x emissions reduction, then followed by a spray dryer absorber and a pulse-jet fabric baghouse for acidic gases, toxic metals and PM emissions reduction.

II. TESTING REQUIREMENTS.**# 004 [25 Pa. Code §127.12b]****Plan approval terms and conditions.**

(a) If at any time the Department has cause to believe that air contaminant emissions from any source may be in excess of the limitations specified in this Plan Approval, or established pursuant to, any applicable rule or regulation contained in 25

**SECTION E. Source Group Plan Approval Restrictions.**

Pa. Code Article III, the permittee shall be required to conduct whatever tests that are deemed necessary by the Department to determine the actual emission rate(s).

(b) Such testing shall be conducted in accordance with the provisions of 25 Pa. Code Chapter 139 and the most current version of the DEP Source Testing Manual, when applicable, and in accordance with any restrictions or limitations established by the Department at such time as it notifies the permittee that testing is required.

005 [25 Pa. Code §127.12b]
Plan approval terms and conditions.

[Additional authority for this permit condition is also derived from 25 Pa. Code Chapter 139.]

(a) The permittee shall perform a stack test using the Department-approved procedures, to show compliance with the emission limits set for the source. The Source testing shall be performed within 180 days after startup of each of the ammonia SNCR control devices. Performance tests shall be conducted while the source is operating at maximum routine operating conditions or under such other conditions, within the capacity of the equipment, as may be requested by the Department.

All procedures and test methods, if not specified below, shall be in accordance with Department's Source Testing Manual (the current revision), or source testing procedures approved by the Department.

(b) The amount and type(s) of waste incinerated during a stack test shall be an adequate representation of the waste processed by the facility.

(c) The stack tests shall consist of a minimum of three test runs conducted under representative full load operating conditions for the following:

- (1) NOx emissions
- (2) ammonia slip

(A) If the emissions from any one of the combustors equal to or exceed 80% of the emission limitations, that combustor(s) shall be tested semiannually. Testing frequency can revert back to annually when the tested emissions are less than 80% of the emission limitation for a consecutive period of 24-months, plus the permittee notifies the Department of such testing schedule reversion.

(B) The permittee may use CEMS Relative Accuracy Test Audits (RATA) in lieu of stack testing for NOx emissions.

(d) Unless approved by the Department prior to the testing, the following procedures and test methods shall be used to determine compliance with the emission limits:

- (1) EPA reference method 1, for the sampling sites and traverse points.
- (2) EPA reference method 3 or 3A, for the gas analysis.
- (3) EPA reference method 7, 7A, 7C, 7D, or 7E, for the RATA test on the NOx CEMS.
- (4) PADEP approved method for ammonia slip concentration.

Each combustor shall be equipped with test ports so that periodic measurement of the 1800°F for one (1) second residence time requirement can be conducted at the Department's request.

(e) Schedule

(1) At least 90 days prior to the test, the permittee shall submit to the Department for approval the procedures for the test and a sketch with dimensions indicating the location of sampling ports and other data to ensure the collection of representative samples. The test procedure shall also include the following:

- (A) amount of waste to be combusted;
- (B) composition and classification of waste;
- (C) Btu content of waste.

(2) At least thirty (30) days prior to the test, the Regional Air Quality Manager shall be informed of the date and time of the

**SECTION E. Source Group Plan Approval Restrictions.**

test.

(3) Within sixty (60) days after the source test(s), the permittee shall submit a complete test report to the Department. The test report shall also include the following which shall be recorded simultaneously with each test day:

- (A) amount of waste combusted (in ton/hr), composition and classification of waste, and BTU value of waste;
- (B) flue gas NO_x and oxygen data recorded using the CEMS and CSM; and
- (C) flue gas combustion temperature (furnace roof top temperature values plus 950 °F), recorded by the CMS.

(4) In the event that any of the above deadlines cannot be met, the permittee may request an extension for the due date(s) in writing and include a justification for the extension. The Department may grant an extension for a reasonable cause.

(f) The permittee shall email all source test submissions (notifications, protocols, reports, supplemental information, etc.) to both the Air Quality Program Manager of the Southeast Regional Office and the PSIMS Administrator in Central Office. Any questions and/or concerns regarding source testing submissions may be sent to the PSIMS Administrator.

AQ Manager of Southeast Region
RA-EPSEstacktesting@pa.gov

PSIMS Administrator
RA-EPstacktesting@pa.gov

The following pertinent information shall be indicated on the title page of all submissions.

(1) Test Date(s)

- (A) For protocols, providing the proposed date on which testing will commence or "TBD"
- (B) For reports, providing the first and last dates of testing

(2) Facility Identification Number (Facility ID, or PF ID).

(3) Source ID(s) as specified in this permit

(4) Testing requirements

(5) Operating permit number

(6) If a submittal includes confidential information, the permittee shall submit both a public copy, which has been redacted, and a confidential copy. The cover page of each submittal should state whether it is a "Public Copy" or "Confidential Copy" and each page of the latter must be marked "CONFIDENTIAL".

(g) Per 25 Pa. Code 139.11(1), performance tests shall be conducted while the source is operating at maximum routine operating conditions or under such other conditions, within the capacity of the equipment, as may be requested by DEP. Maximum routine operating conditions:

- (1) represent the range of combined process and control measure conditions under which the facility expects to operate (regardless of the frequency of the conditions), and
- (2) are likely to most challenge the emissions control measures of the facility with regard to meeting the applicable emission standards, but without creating an unsafe condition.

DEP is requesting that the stack testing not be stopped or postponed to avoid periods of routine operating conditions, such as the incineration of "wet waste", except during air emission testing for polychlorinated dibenzodioxins and furans (PCDDs/PCDFs), when future operations are (or would be) limited to the maximum steam flow (lbs/hour) during the testing.

III. MONITORING REQUIREMENTS.

006 [25 Pa. Code §127.12b]

Plan approval terms and conditions.

[Additional authority for this permit condition is also derived from 25 Pa. Code § 129.115(b)(3).]

The permittee shall demonstrate compliance with the NO_x emission limitation as specified in Condition #002(a) under Source Group Name: Group 2, by performing the following monitoring and testing procedures:

**SECTION E. Source Group Plan Approval Restrictions.**

- (a) using a daily average according to the requirements in Chapter 139, Subchapter C;
- (b) the daily average will be considered valid if it contains at least 18 valid hourly averages reported at any time during the calendar day as required in the quality assurance section of the continuous source monitoring manual.

IV. RECORDKEEPING REQUIREMENTS.**# 007 [25 Pa. Code §127.12b]****Plan approval terms and conditions.**

[Additional authority for this permit condition is also derived from 25 Pa. Code § 129.115(f).]

- (a) The records shall include sufficient data and calculations to demonstrate that the requirements of 25 Pa. Code §§129.111 through 129.114 are met.
- (b) Data or information required to determine compliance shall be recorded and maintained in a time frame consistent with the averaging period of the requirement.
- (c) The records necessary to determine compliance shall be reported to the Department or appropriate approved local air pollution control agency on a schedule specified in the applicable regulation or as otherwise specified in the operating permit or plan approval for the air contamination source.

V. REPORTING REQUIREMENTS.

No additional reporting requirements exist except as provided in other sections of this plan approval including Section B (Plan Approval General Requirements).

VI. WORK PRACTICE REQUIREMENTS.

No additional work practice requirements exist except as provided in other sections of this plan approval including Section B (Plan Approval General Requirements).

VII. ADDITIONAL REQUIREMENTS.**# 008 [25 Pa. Code §127.12b]****Plan approval terms and conditions.**

As a moderate nonattainment area, Pennsylvania is required to attain the 2015 ozone NAAQS as expeditiously as practicable, but no later than 6 years after the initial designation as nonattainment (83 FR 10376). The initial nonattainment designation occurred on August 3, 2018 (83 FR 25776) meaning Pennsylvania is required to attain the 2015 ozone NAAQS no later than August 3, 2024. Attaining the 2015 ozone NAAQS includes the complete implementation of RACT which means all RACT measures, including the installation and operation of all RACT control devices, must occur before August 3, 2024.



SECTION F. Alternative Operation Requirements.

No Alternative Operations exist for this Plan Approval facility.

**SECTION G. Emission Restriction Summary.**

Source Id	Source Descriptor		
101	ROTARY COMBUSTER 1		
Emission Limit		Pollutant	
5.000	PPMV	dry basis, at 7% oxygen	Ammonia
0.420	Lbs/MMBTU		NOX
54.120	Lbs/Hr		NOX
110.000	PPMV	dry basis, at 7% oxygen, daily average	NOX
102	ROTARY COMBUSTER 2		
Emission Limit		Pollutant	
5.000	PPMV	dry basis, at 7% oxygen	Ammonia
0.420	Lbs/MMBTU		NOX
54.120	Lbs/Hr		NOX
110.000	PPMV	dry basis, at 7% oxygen, daily average	NOX
103	ROTARY COMBUSTER 3		
Emission Limit		Pollutant	
5.000	PPMV	dry basis, at 7% oxygen	Ammonia
0.420	Lbs/MMBTU		NOX
54.120	Lbs/Hr		NOX
110.000	PPMV	dry basis, at 7% oxygen, daily average	NOX
104	ROTARY COMBUSTER 4		
Emission Limit		Pollutant	
5.000	PPMV	dry basis, at 7% oxygen	Ammonia
0.420	Lbs/MMBTU		NOX
54.120	Lbs/Hr		NOX
110.000	PPMV	dry basis, at 7% oxygen, daily average	NOX
105	ROTARY COMBUSTER 5		
Emission Limit		Pollutant	
5.000	PPMV	dry basis, at 7% oxygen	Ammonia
0.420	Lbs/MMBTU		NOX
54.120	Lbs/Hr		NOX
110.000	PPMV	dry basis, at 7% oxygen, daily average	NOX
106	ROTARY COMBUSTER 6		
Emission Limit		Pollutant	
5.000	PPMV	dry basis, at 7% oxygen	Ammonia
0.420	Lbs/MMBTU		NOX
54.120	Lbs/Hr		NOX
110.000	PPMV	dry basis, at 7% oxygen, daily average	NOX

Site Emission Restriction Summary

Emission Limit	Pollutant
----------------	-----------



SECTION G. Emission Restriction Summary.



SECTION H. Miscellaneous.



***** End of Report *****
