

Drinking Water Plant Operator Certification Training



Module 20: Corrosion Control and Sequestering

May 2016

This course includes content developed by the Pennsylvania Department of Environmental Protection (Pa. DEP)

Topical Outline

Unit 1 – Lead and Copper Rule

- I. Overview of corrosion control and the Lead and Copper Rule Regulation Quick Reference Guide
 - A. Major Monitoring Provisions
 - B. Treatment Technique and Sampling Requirements if the Action Level is Exceeded
- II. Sampling Protocol
 - A. Lead and Copper
 - B. Water Quality Parameters
- III. EPA Methods

Unit 2 – Corrosion Principles and Theory

- I. Chemistry Review
 - A. Ionization
 - B. Acids, Bases and Salts
 - C. pH
 - D. The Carbonate System
 - E. Basic Corrosion Theory
 - F. Factors Affecting Corrosion
 - G. Traditional vs. LCR Treatment Objectives
 - H. LCR CCT Alternatives
- II. Corrosion Treatment Theory
 - A. pH/Alkalinity Adjustment
 - B. Corrosion inhibitors
 - C. Calcium carbonate precipitation

Unit 3 – Corrosion Control Chemicals

- I. pH/Alkalinity Adjustment Chemicals
 - A. Common Chemical Names
 - B. Chemical Characteristics
 - C. Operational Considerations
 - D. Impacts and Constraints of pH/Alkalinity chemicals or CaCO₃ precipitation
- II. Corrosion Inhibitors
 - A. Phosphate inhibitors

- B. Inhibitor Fact Sheets
- C. Silicates Fact Sheet
- D. Impacts and Constraints of Inhibitors

Unit 4 – Chemical Feed Systems

- I. Components of a Liquid Chemical Feed System
- II. Liquid chemical feed system Operation and Maintenance activities
- III. Components of a Dry Feed System
- IV. Dry chemical feed system Operation and Maintenance activities
- V. Chemical Feed Calculations
 - A. Mixing a Percent Solution
 - B. Determining Weight of % Solution Using Specific Gravity
 - C. Dry Feed and Liquid Feed Rate Calculations
 - D. Calculating the Active Ingredient Weight of a % Solution
- VI. Pump Calibration

Appendix

- Corrosion Chemicals Table
- MSDS for 50% caustic soda

Unit 1 – The Lead and Copper Rule

Learning Objectives

- Review the major provisions of the Lead and Copper Rule.
- Review the sampling protocols for lead and copper tap samples and water quality parameter samples.
- Review selected EPA-approved analytical methods.

Corrosion Control and Sequestration Overview



Corrosion refers to the gradual decomposition or destruction of a material by chemical action, often due to an electrochemical reaction. Corrosion may be caused by (1) stray current electrolysis, (2) galvanic corrosion caused by dissimilar metals, or (3) differential-concentration cells.



Sequestration refers to a chemical complexing (forming or joining together) of metallic cations (such as iron) with certain inorganic compounds, such as phosphate. Sequestration prevents the precipitation of the metals (iron).

- Corrosion can cause economic, health, and aesthetic problems. Economic problems result from damage to pipes, storage tanks, valves and meters.

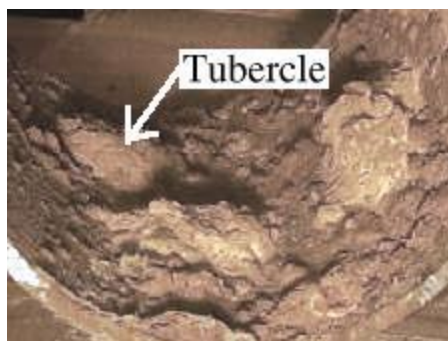

- When pipes are corroded, some of the metal from the pipes enters the drinking water and is consumed by the customer. If that pipe contains lead and copper, the water is hazardous to the customer's health.
- Chemical treatment of corrosive water
 - Stabilizing the water is often the simplest form of corrosion control.
 - As pH increases, corrosion decreases.
 - As alkalinity increases, corrosion decreases.
 - Add alkalinity in the form of lime, soda ash, or caustic soda to make the water stable or slightly scale-forming.
 - The second type of corrosion control treatment is the use of corrosion inhibitors.
 - Corrosion inhibitors are specially formulated chemicals that:
 - Form thin protective films on pipe walls which can prevent corrosion.
 - Can be used to control scale build up.
 - Types of inhibitors include:
 - Phosphate inhibitors (polyphosphates, Orthophosphates, Ortho/Poly blends)
 - Silicate Inhibitors

CORROSION CONTROL AND SEQUESTRATION OVERVIEW

- Sequestering
 - Polyphosphates are also sequestering agents:
 - They keep iron, manganese and calcium in solution thereby preventing the formation of precipitates that could deposit scale or cause discoloration.

In 1993, DEP promulgated the Lead and Copper Rule. This rule is designed to minimize the lead and copper concentrations at consumer's tap, primarily by reducing water corrosivity. The rule is quite comprehensive so we'll review some of the major provisions by looking at a quick reference guide.

Here are a few definitions that relate to the Lead and Copper Rule.

Definitions



Action level refers to the level at which water suppliers are required to take additional actions such as water quality parameter (WQP) monitoring, corrosion control treatment (CCT), source water monitoring/treatment, public education (PE) and lead service line replacement (LSLR). The lead and copper action levels are based on the 90th percentile levels.



Action level exceedance occurs when the concentration of a contaminant in more than 10% of tap water samples is greater than the **action level of 0.015 mg/L for lead or 1.3 mg/L for copper**.



Optimal corrosion control treatment refers to treatment which minimizes the lead and copper concentrations at users' taps while ensuring that the treatment does not cause the system to violation a primary MCL.



Water quality parameters include: pH, alkalinity, calcium (initial only, unless calcium carbonate stabilization is used), conductivity (initial monitoring only), orthophosphate (if inhibitor is phosphate-based), silica (if inhibitor is silica-based, and temperature (initial monitoring only).

LEAD AND COPPER RULE: A QUICK REFERENCE GUIDE

Lead and Copper Rule: A Quick Reference Guide

Overview of the Rule	
Title	Lead and Copper Rule
Purpose	Protect public health by minimizing lead (Pb) and copper (Cu) levels in drinking water, primarily by reducing water corrosivity. Pb and Cu enter drinking water mainly from corrosion of Pb and Cu containing plumbing materials.
General Description	Establishes an action level (AL) of 0.015 mg/L for lead and 1.3 mg/L for copper based on the 90 th percentile level of tap water samples. An AL exceedance is not a violation but can trigger other requirements that include water quality parameter (WQP) monitoring, corrosion control treatment (CCT), source water monitoring/treatment, public education (PE) and lead service line replacement (LSLR).
Applicability	All community water systems (CWSs) and nontransient noncommunity water systems (NTNCWSs) are subject to the LCR requirements.
Public Health Benefits	
Implementation of the LCR has resulted in	<ul style="list-style-type: none"> • Reduction in risk of exposure to Pb that can cause damage to brain, red blood cells, and kidneys, especially for young children and pregnant women. • Reduction in risk of exposure to Cu that can cause stomach and intestinal distress, liver or kidney damage, and complications of Wilson’s disease in genetically predisposed people.
Consumer Tap Notice	
<p>Within 30 days of learning the results, all systems must deliver a consumer tap notice of the lead tap water results to persons served by the water at sites that are sampled under §109.1103. Water systems can use the “Instructions for Consumer Notice of Tap Results” (3900-FM-BSDW0209) located at: http://www.elibrary.dep.state.pa.us/dsweb/View/Collection-10810</p> <p>Within three months of the end of the monitoring period in which lead tap monitoring was conducted, a water supplier must submit a sample copy of the consumer notice along with a certification form (3900-FM-BSDW0205) that the notices were distributed by mail or by another method approved by DEP. This certification form is located at: http://www.elibrary.dep.state.pa.us/dsweb/View/Collection-10957</p>	

LEAD AND COPPER RULE: A QUICK REFERENCE GUIDE

Major Monitoring Provisions	
Lead and Copper Tap	
Applicability	<ul style="list-style-type: none"> All CWSs and NTNCWSs.
Initial	<ul style="list-style-type: none"> CWSs and NTNCWSs must collect first-draw samples at taps in homes/buildings that are at high risk of Pb/Cu contamination as identified in §109.1103(g)(2). Number of samples is based on system size (see Table 1). System must conduct monitoring every six months unless they qualify for reduced monitoring.
Reduced	<ul style="list-style-type: none"> See Table 1 for sample number and Table 2 for criteria.
Water Quality Parameters (WQPs)	
Applicability	<ul style="list-style-type: none"> Systems serving more than 50,000 people. Systems serving 50,000 or less people during monitoring periods in which either AL is exceeded.
Initial	<ul style="list-style-type: none"> Two sets of WQP samples are collected at distribution sites every six months. One set of WQP samples is collected at each entry point every six months prior to CCT installation, then every two weeks.
Reduced	<ul style="list-style-type: none"> See Table 1 for sample number and Page 4 for criteria. Entry point monitoring cannot be reduced.
Source Water Monitoring	
Applicability	<ul style="list-style-type: none"> Systems that exceed Pb or Cu AL.
Purpose	<ul style="list-style-type: none"> Determine contribution from source water to total tap water Pb and Cu levels and need for source water treatment.
Timing	<ul style="list-style-type: none"> One set of samples at each entry for parameter that exceeded the AL within six months of first AL exceedance.

LEAD AND COPPER RULE: A QUICK REFERENCE GUIDE

Table 1: Lead and Copper Tap and WQP Distribution Monitoring

Size Category	System Size	Number of Pb/Cu Tap Sample Sites		Number of WQP Distribution Sites (2 sets at each site)	
		Initial	Reduced	Initial	Reduced
Large	>100,000	100	50	25	10
	50,001 – 100K	60	30	10	7
Medium	10,001 – 50K	60	30	10	7
	3,301 – 10K	40	20	3	N/A
Small	501 – 3,300	20	10	2	N/A
	101 - 500	10	5	1	N/A
	100 or fewer	5	5	1	N/A

Table 2: Criteria for Reduced Pb/Cu Tap Monitoring

Annual	<ol style="list-style-type: none"> 1. Small and medium systems that meet both ALs for two consecutive 6-month monitoring periods; or 2. Any system that has installed CCT and meets both ALs for two consecutive 6-month monitoring periods and maintains the range of optimal WQP performance level requirements (PLRs).
Triennial	<ol style="list-style-type: none"> 1. Small and medium systems that meet both ALs for three consecutive years of monitoring, including initial monitoring; or 2. Any system that has installed CCT and meets both ALs for three consecutive years of 6-month or annual monitoring periods and maintains the range of optimal WQP PLRs for three consecutive years; or 3. Any system with 90th percentile Pb and Cu levels of ≤ 0.005 mg/L and ≤ 0.65 mg/L, respectively, for two consecutive 6-month monitoring periods.
9 Years	Small systems that meet the materials and monitoring criteria found under §109.1103(k) may apply to DEP for a waiver.

LEAD AND COPPER RULE: A QUICK REFERENCE GUIDE

Treatment Technique and Sampling Requirements if the AL is Exceeded*	
*Based on the 90th percentile value. Refer to §109.1102(a)(4) for computation steps.	
Water Quality Parameter (WQP)	
Applicability	Refer to Page 2.
Parameters	<ul style="list-style-type: none"> pH, alkalinity, calcium (<i>initial only, unless calcium carbonate stabilization is used</i>), conductivity (<i>initial monitoring only</i>), orthophosphate (if inhibitor is phosphate-based), silica (if inhibitor is silica-based, and temperature (<i>initial monitoring only</i>)).
Frequency	<ul style="list-style-type: none"> Systems installing CCT must conduct follow-up monitoring for two consecutive 6-month monitoring periods. WQP distribution monitoring is conducted every six months and entry point monitoring is conducted every two weeks. After follow-up monitoring, DEP will designate optimal CCT WQP PLRs.
Reduced Distribution Monitoring	<ul style="list-style-type: none"> Collects at reduced number of sampling sites (Table 1) if a system maintains the range of WQP performance requirements for two consecutive 6-month monitoring periods. Reduces frequency from 6-month monitoring to annual if WQP PLRs are met during three consecutive years of monitoring. Reduces frequency from annual to triennial if during two consecutive 6-month monitoring periods the WQP PLRs are met AND the 90th percentile Pb and Cu levels are ≤ 0.005 mg/L and ≤ 0.65 mg/L, respectively.
Corrosion Control Treatment (CCT)	
Applicability	<ul style="list-style-type: none"> All large systems Small and medium systems that exceed either AL; may stop CCT steps if both ALs are met during two consecutive 6-month monitoring periods prior to approval to construct CCT facilities; but must resume CCT if subsequently exceed either AL.
CCT Compliance Schedule	<p>All activities begin from the end of the monitoring period in which the AL was exceeded:</p> <ul style="list-style-type: none"> Submit a CCT feasibility study within 18 months. Submit a permit application within 30 months.

LEAD AND COPPER RULE: A QUICK REFERENCE GUIDE

	<ul style="list-style-type: none"> • Initiate construction or modification of CCT facilities within 48 months. • Complete construction or modification of CCT facilities within 60 months.
Follow-up Monitoring & WQP PLRs	<ul style="list-style-type: none"> • Conduct two consecutive 6-month monitoring periods of Pb/Cu tap and WQP monitoring. • Within 30 days of end of follow-up monitoring, submit request to DEP to designate WQP PLRs.

Treatment Technique Requirement if the Lead AL is Exceeded*	
*Based on the 90th percentile value. Refer to §109.1102(a)(4) for computation steps.	
Lead Public Education (PE)	
Applicability	<ul style="list-style-type: none"> • Systems that exceed the Pb AL.
Purpose	<ul style="list-style-type: none"> • Educates consumers about lead health effects, sources, and steps to minimize exposure.
PE Material Content	<ul style="list-style-type: none"> • Must meet EPA requirements established under 40 CFR 141.85(a)(1) and (2). EPA has developed numerous documents and PE material templates that are located at this site: https://www.epa.gov/dwreginfo/lead-and-copper-rule-compliance-help-public-water-systems • NTNCWs and CWSs that receive DEP approval to follow the NTNCWs delivery methods may use the “Instructions & Template for NTNCWs Lead PE Poster” (3900-FM-BSDW0137) located at this site: http://www.elibrary.dep.state.pa.us/dsweb/View/Collection-10963

LEAD AND COPPER RULE: A QUICK REFERENCE GUIDE

Delivery Method	<ul style="list-style-type: none"> Systems must submit copies of PE materials to DEP prior to delivery. CWSs: Deliver materials to bill-paying customers and post lead information on water bills, work in concert with local health agencies to reach “at-risk” populations (children, pregnant women), deliver to other organizations serving “at-risk” populations, provide press releases, include new outreach activities from §109.1104(a)(2)(i)(H), and post PE materials to website if system serves > 100,000 people. NTNCWs: Posting and distribution to all customers (can be electronic).
Timing	<ul style="list-style-type: none"> Within 60 days after the end of the monitoring period in which Pb AL was exceeded if not already delivering PE. Repeat annually except: quarterly water bill inserts, press releases twice a year, and continuous web posting. Discontinue whenever Pb AL is met; but must resume PE program if subsequent Pb AL is exceeded.

Treatment Technique Requirement if the Lead AL is Exceeded*	
*Based on the 90th percentile value. Refer to §109.1102(a)(4) for computation steps.	
Lead Service Line Replacement (LSLR)	
Applicability	<ul style="list-style-type: none"> Systems that exceed Pb AL after installing CCT. Can discontinue LSLR whenever Pb AL is met during two consecutive 6-month monitoring periods. Must resume LSLR for subsequent Pb AL exceedance.
Monitoring	<ul style="list-style-type: none"> Optional: Sample from LSL to determine if line must be replaced. If all samples are ≤ 0.015 mg/L, line is considered “replaced through testing”; however, must reconsider these lines if Pb AL is subsequently exceeded. Required: Sample from any partial LSLs replacements to determine impact on Pb levels.
Replacement	<ul style="list-style-type: none"> Must replace at least 7 percent of LSLs annually; DEP may require a system to replace lines on a shorter schedule when it is feasible.

LEAD AND COPPER RULE: A QUICK REFERENCE GUIDE

Partial LSL	<ul style="list-style-type: none">• Notify residents at least 45 days prior to replacement about potential for increased Pb levels.• Collect partial LSL Pb sample within 72 hours of replacement and provide results to the owner and residents within three days of receiving the results.
Additional Resources	
DEP LCR web page	This page includes many links to various LCR resources: http://www.dep.pa.gov/Business/Water/BureauSafeDrinkingWater/DrinkingWaterMgmt/Regulations/Pages/Lead-and-Copper-Rule.aspx
Subchapter K of Chapter 109	Subchapter K contains all the Lead and Copper Rule requirements for Pennsylvania public water systems: http://www.pacode.com/secure/data/025/chapter109/subchapKtoc.html
EPA LCR documents	This page provides comprehensive technical guidance documents for all aspects of the Federal Lead and Copper Rule: https://www.epa.gov/dwreginfo/lead-and-copper-rule-compliance-help-public-water-systems

WATER SAMPLE COLLECTION PROTOCOL

WATER SAMPLE COLLECTION PROTOCOL

LEAD AND COPPER TAP SAMPLES

- 1 liter sample size;
- First-draw after **six hour standing time**. **Do not intentionally flush the water line before the start of the six hour period;**
- Cold water kitchen or bathroom tap OR interior tap used for consumption **Do not remove the aerator prior to sampling, open the cold water tap as you would do to fill a glass of water;**
- Collected by the water supplier or residents (residents must be instructed of proper sampling procedures);
- If residents perform sampling, system may not challenge, based on alleged errors in sample collection or accuracy of sampling results;
- Samples can be acidified up to 14 days after the sample is collected. After acidification, the sample shall stand in original container for the time specified according to the approved EPA method before analyzing the sample;
- For subsequent monitoring, system shall make reasonable effort to collect each first-draw tap sample from same sampling site from which it collected a previous sample. If system is unable to use an original sampling site, system may collect the tap sample from another sampling site in its sampling pool as long as new site meets same targeting criteria, and is within reasonable proximity to original site; and
- Collect early in monitoring period in order to allow time for collection of water quality parameter samples during same period if necessary.

The department will only consider lead and copper samples analyzed by a certified laboratory.

WATER SAMPLE COLLECTION PROTOCOL

WATER QUALITY PARAMETER SAMPLES

- Remove faucet aerator and fully flush the line;
- If collecting water quality parameter samples from the same location as coliform and disinfectant residual samples, collect coliform samples first; then measure disinfectant residual, temperature and pH; and finally collect samples for other water quality parameters;
- Collect samples in two 500 ml plastic or glass containers (plastic container must be used for silica);
- Measure temperature in the field;
- Measure pH in the field within 15 minutes of sample collection with a calibrated meter capable of measuring to 1/10 of a unit;
- Avoid agitating the water sample;
- Record observations about color, suspended solids, and flushing time required prior to sample collection;
- Store samples in a cool environment until analyzed;
- The two sets of water quality parameter samples should be collected at different times in the monitoring period to insure data is representative of seasonal changes.

Measurements for water quality parameters may be performed by a certified laboratory or by a person meeting the operator certification requirements. Proper analytical methods shall be used.

ANALYTICAL METHODS AND LABORATORY CERTIFICATION
--

EPA-approved analytical methods are designated in the rule and are as follows:

CONTAMINANT	METHODOLOGY	EPA	ASTM ¹	SM ²	OTHER
<i>Lead</i>	Atomic absorption; furnace ICP-Mass Spectrometry Atomic absorption; platform Differential pulse anodic stripping voltammetry	200.8 200.9	D3559-95D	3113B	1001
<i>Copper</i>	Atomic absorption; furnace Atomic absorption; direct aspiration ICP ICP-Mass spectrometry Atomic absorption; platform	200.7 200.8 200.9	D1688-95C D1688-95A	3113B 3111B 3120B	
<i>pH</i>	Electrometric	150.1 150.2	D1293-95	4500-H ⁺ -B	
<i>Conductivity</i>	Conductance		D1125-91A	2510B	
<i>Calcium</i>	EDTA titrimetric Atomic absorption; direct aspiration Inductively coupled plasma	200.7	D511-93A D511-93B	3500-Ca-D 3111B 3120B	
<i>Alkalinity</i>	Titrimetric Electrometric titration		D1067-92B	2320B	I-1030-85
<i>Ortho-phosphate, unfiltered, no digestion or hydrolysis</i>	Colorimetric, automated, ascorbic acid Colorimetric, ascorbic acid, single reagent Colorimetric, phosphomolybdate Colorimetric, automated-segment flow Colorimetric, automated discrete Ion chromatography	365.1 300.0	 D515-88A D4327-91	4500-P-F 4500-P-E 4110 B	 I-1602-85 I-2601-90 I-2598-85
<i>Silica</i>	Colorimetric Colorimetric: molybdate blue Colorimetric: automated-seg. flow Molybdosilicate Heteropoly blue Automated method for molybdate-reactive silica Inductively coupled plasma	 200.7	D859-88	 4500-Si-D 4500-Si-E 4500-Si-F 3120B	 I-1700-85 I-2700-85
<i>Temperature</i>	Thermometric			2550B	



Key points for Unit 1 – The Lead and Copper Rule and Water Sampling Protocol

- Corrosion causes economic, health, and aesthetic problems.
- Sequestering agents keep iron, manganese and calcium in solution thereby preventing the formation of precipitates that could deposit scale or cause discoloration.
- The Lead and Copper Rule was written to minimize user's exposure to lead and copper levels.
- The action levels for lead and copper are based on the **90th percentile levels**. This means that an action level exceedance occurs when the concentration of a contaminant in more than 10% of tap water samples is greater than the **action level of 0.015 mg/L for lead or 1.3 mg/L for copper**.
- When a water system exceeds the lead action level, the system is required to conduct a lead public education program within 60 days of the exceedance.
- A lead and copper tap sample must be collected from a tap that has not been used for at least 6 hours.
- The pH measurement must be analyzed within 15 minutes of sample collection with a calibrated meter capable of measuring to 1/10 of a unit.
- When collecting water quality parameters, water suppliers are required to use EPA-approved analytical methods.



Exercise for Unit 1 – Background and Properties

1. Under the LCR, insert the population sizes for the following types of systems:

System Size	Population Served
Small	
Medium	
Large	

2. Based on the following lead tap sample results, what is the 90th percentile value of the following samples? _____
 Is this system exceeding the action level? _____

Sample site	Lead Level (mg/L)
1	0.020
2	0.018
3	0.016
4	0.014
5	0.011
6	0.010
7	0.009
8	0.008
9	0.007
10	0.006

3. When a small or medium system exceeds an AL, name the first step in the corrosion control treatment activity milestones? Submit a CCT _____ within 18 months.

4. Which of the following parameters are considered water quality parameters?
Circle all that apply.
- a. Temperature
 - b. Conductivity
 - c. pH
 - d. alkalinity
 - e. odor
5. Systems serving 50,000 or less people (i.e. small or medium systems) must collect WQP samples during monitoring periods in which either AL is exceeded.
- a. True_____ b. False_____
6. The sample volume size for a lead and copper tap sample is:
- a. 500 ml b. 1 Liter
7. An operator must measure pH within ___ minutes of sample collection.
8. What methodology is **NOT** an EPA-approved method?
- a. Titrimetric
 - b. Electrometric
 - c. Colorimetric
 - d. Color Wheel

Unit 2 – Corrosion Principles and Theory

Learning Objectives

- Review a few chemistry principles that relate to corrosion.
- Explain how corrosion of lead and copper occurs.
- Identify factors which affect corrosion.
- Compare traditional corrosion control treatment objectives to the CCT objective under the LCR.
- Identify the LCR Corrosion Control Treatment Alternatives.
- Explain how the three types of CCT alternatives work.
- Describe the important factors affecting each type of treatment.

Chemistry

Ionization

The chemical process that is responsible for corrosion is called **ionization**.



Ionization is the process by which an atom or a molecule acquires a negative or positive charge by gaining or losing electrons.

- In other words, an **ion** is an electrically charged atom formed by the loss or gain of electrons.
- The electron is now free to travel to an element that is looking to gain electrons to become stable. Chlorine is one of those elements.

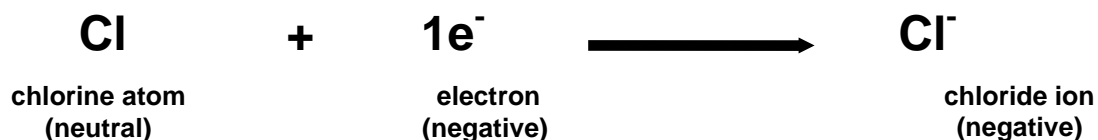
EXAMPLE #1: Chlorine

- When the neutral chlorine atom steals an electron it becomes a chloride ion with a charge of -1.
- The number of electrons an element gains or loses determines the charge on the ion.
 - For example, an element that loses two electrons would produce an ion with a charge of +2.

EXAMPLE #2: Sodium chloride (NaCl)

NaCl is a common substance that is made up of the element sodium (the symbol is Na) and the element chlorine (Cl).

Salt is entirely different from the two elements that combine to form it: sodium, a shiny, soft, grey metal, and chlorine, a deadly, greenish-yellow gas.

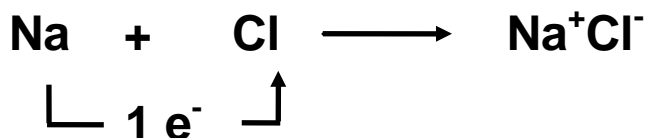

- When these two elements combine, the sodium atom loses an electron to the chlorine.

- Salt, then, is actually a compound made up of one sodium ion and one chloride ion.
- The sodium and chloride ions (one is positive and one is negative) are attracted to each other because the opposite charges attract.

If you add salt to water, the ions will separate and free up electrons to move.



The Chemistry of Water

Let's look more closely at the chemistry of water.

Water is a compound that is formed when two hydrogen atoms combine with one oxygen atom.

The ionization of water can be shown using the chemical formula.



- You can see that when water ionizes, one hydrogen and one hydroxide ion are produced.
- The hydrogen ion has a charge of +1 because it gives up its one electron.
- The hydroxide ion takes that electron, giving it a charge of -1.

Hydrogen ions and hydroxide ions in water play a critical role in water chemistry and corrosion.

Acids, Bases and Salts

Acids:

- When dissolved in water, certain substances produce hydrogen ions.
- Substances that produce hydrogen ions in water are called **acids**.
- Acids can usually be recognized by the "H" at the beginning of the chemical formula.

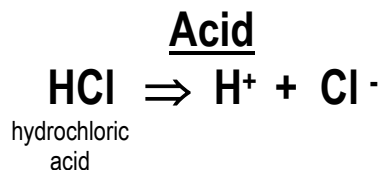

- The positive hydrogen ion is attached to a negative ion such as the chloride ion in hydrochloric acid.
- When dissolved in water, the hydrochloric acid molecule ionizes, freeing up the hydrogen ion.

Bases:

- A **base** is a substance that produces hydroxide ions in water.
- Bases can usually be recognized by the “OH” at the end of their chemical formula.

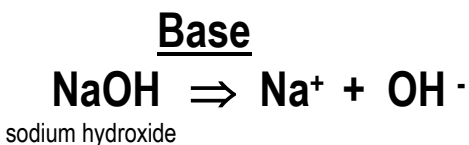

- The negative hydroxide ion is attached to a positive ion like sodium in the base sodium hydroxide.
- When dissolved in water the molecule ionizes, freeing up the hydroxide ion.

Salts:

- When an acid and base react together, the hydrogen and hydroxide ions combine and neutralize each other, forming water together with a salt.
- A **salt** is the product of combining an acid and a base.
- Salts normally do not produce either hydrogen or hydroxide ions.

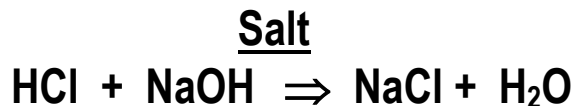

- Sodium chloride or common table salt, which we discussed earlier, is formed when hydrochloric acid (HCl) reacts with sodium hydroxide.

pH

pH is the measurement of the concentration of hydrogen ions in water.

You can actually measure how acidic or basic a water is using a scale known as the pH scale.

The pH scale is a logarithm scale based on 10.

- The range of H⁺ ion is from a high of 1.0 down to 0.000 000 000 000 01 or 10⁻¹⁴
 - This is done so that pH can be represented on a scale of 0 to 14.
 - Zero represents a concentration of 1.0 and 14 represents a concentration of 10⁻¹⁴.

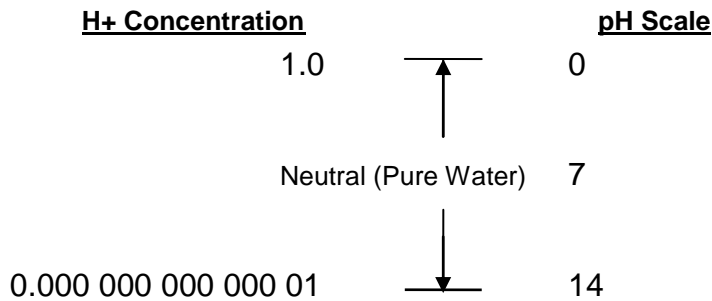

pH Scale

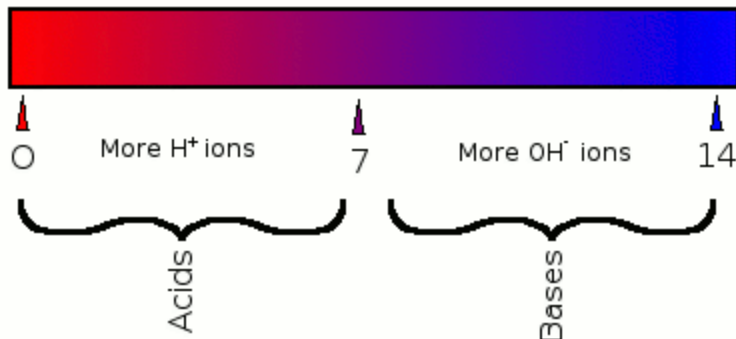

- The balance of the H⁺ and OH⁻ determines the pH of the water. Adding an acid to neutral water increases the number of hydrogen ions, conversely adding a base will increase the number of hydroxyl ions.

H⁺ greater than OH⁻ = acidic solution, pH below 7.0

H⁺ less than OH⁻ = basic solution, pH above 7.0

H⁺ = OH⁻ = neutral solution, pH of 7.0

- Adding an acid to water **lowers** the pH.
- Adding a base **raises** it.
- Some salts like soda ash act similar to bases, except they are not as strong. When you add them to water, they tend to **raise** pH; although it takes more chemical than it would for a strong base like caustic soda.

Normally, for raw water, we don't see pH's lower than 4 or higher than 10. Finished water pH most commonly falls between 6.5 and 9.

pH values of common substances.

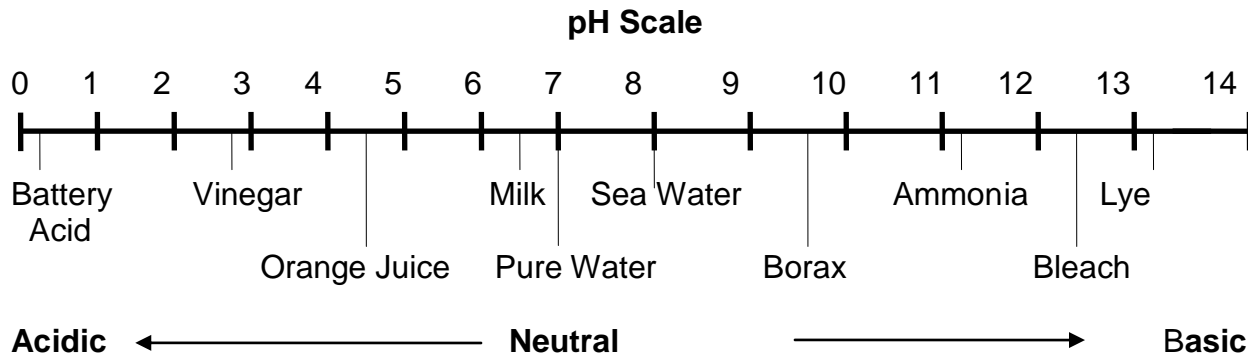

Pure water has a pH of 7.0, right in the middle of the scale.

- Pure water has the same number of hydrogen ions as hydroxide ions.
- So pure water is neither acidic or basic - it is neutral.

The Carbonate System

The carbonate system:

- Is a major acid/base system.
- Produces important reactions in water distribution systems.
- Involves the three carbonate species: carbonic acid, bicarbonate, and carbonate.

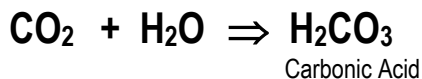

- Carbonic acid is mostly carbon dioxide gas (CO₂) dissolved in water.

The carbonic acid in water is a main factor contributing to corrosiveness of water.

- One of the objectives in corrosion treatment is to remove the carbonic acid.
- The two most common ways of removing carbonic acid are **aeration** and **neutralization**.

Because carbonic acid is mostly carbon dioxide gas dissolved in water, it can be removed by aeration.



Another way to remove the carbonic acid is to **neutralize** the acid by adding a base.

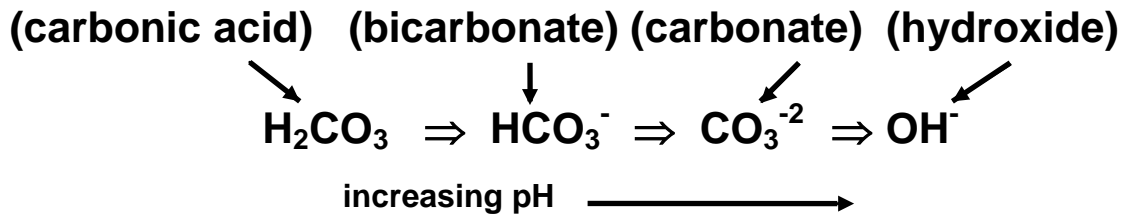

THE CARBONATE SYSTEM

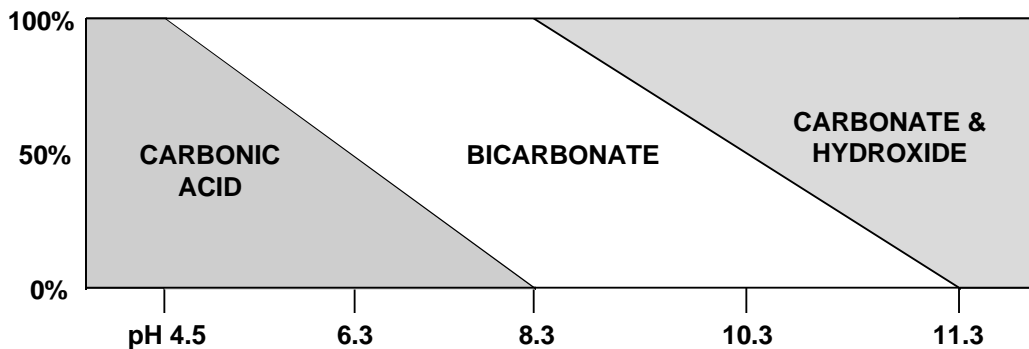

- At pH 4.5 the water contains only **carbonic acid**.
- As pH increases above 4.5, **bicarbonate** begins to form.
- Above 8.3, **carbonate** begins to form and eventually excess **hydroxide** ions are formed.

One goal of corrosion control treatment involves raising the pH of the water to neutralize the carbonic acid.

Definitions



Anode refers to the positive pole (+) that attracts negatively charged particles or ions. The anode is the part of the metal surface that is corroded.



Cathode refers to the negative pole (-) that attracts positively charged particles or ions.



Galvanic cell refers to an electrolytic cell capable of producing electrical energy by electrochemical action. The decomposition of materials in the cell causes an electric (electron) current to flow from cathode to anode.



Galvanic corrosion refers to corrosion that is caused by two different metals or alloys coming in contact with each other. The more active metal corrodes.

Galvanic Series		
ANODE	(Most Active)	Magnesium
↑		Zinc
		Aluminum (2S)
		Cadmium
		Aluminum (175T)
		Steel or iron
		Cast iron
		Lead – Tin solder
		Lead
		Nickel
		Brasses
		Copper
		Bronzes
		Stainless steel (304)
		Monel
		Stainless steel (316)
		Silver
	Graphite	
CATHODE	(Least Active)	Gold

Basic Corrosion Theory

When most substances come in contact with water, they tend to ionize (separate into ions).

Like most metals, lead and copper form positive ions which are soluble in water.



When people drink the water, they ingest the lead or copper.

Sources of Lead and Copper

- Lead leaches from lead pipes and service connections, solder containing lead, and brass fixtures.
- Copper piping is the source of most copper found in drinking water.

CORROSION CELL

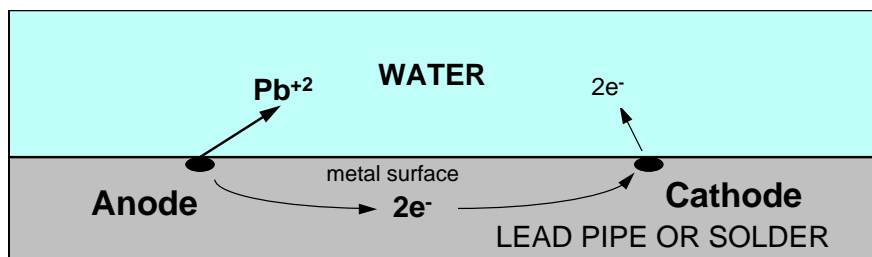

Four elements of an electrochemical cell necessary for corrosion to occur:

1. Anode - where electrons are lost through the metal.
2. Cathode - where electrons are gained and then leave the metal.
3. Connection between the anode and cathode (pipe) - to transport the electrons.
4. Electrolytic solution - (water) to conduct ions between the anode and cathode.

The **anode** is the part of the metal surface that is corroded. This means that the anode is where the metal dissolves and enters the water as a Pb^{+2} ion.

The anode is also the place from which electric current (electrons) flows **through the metal** to the other electrode, the **cathode**.

The **cathode** is the part of the metal surface where the electrons **leave the metal** and return to the anode through the water.

Corrosion will occur as long as this electrical circuit is complete.

Factors Affecting Corrosion

The chemistry of the water has usually the greatest effect on the rate of corrosion. These are the key water chemistry factors affecting corrosion.

- **pH:** As pH decreases, corrosion **increases**.
- **Alkalinity:** Affects the solubility of lead. Helps in keeping a stable pH.
In most cases, as alkalinity increases, corrosion **decreases**.
- **Total dissolved solids (TDS):** Increases conductivity which increases the water's ability to conduct an electrical current. As TDS increases, corrosion **increases**.
- **Temperature:** As temperature increases, corrosion **increases**.
- **Dissolved oxygen (DO):** As DO increases, corrosion **increases**.
- **Chlorides, Sulfates, Nitrates:** As these increase, corrosion **increases**, because they all add TDS to the water increasing its conductivity.
- **Chlorine:** As the addition of gas chlorine increases, corrosion **increases**, because it reduces pH.

Corrosion Control Treatment

Traditional Corrosion Control Treatment Objectives:

- Minimize corrosion rates.
- Maximize the service life of plumbing materials.
- Improve the hydraulic characteristics of water distribution systems
- Mitigate red water problems.

CCT Objective of the LCR:

- To protect public health by minimizing the amount of lead and/or copper dissolving into tap water.

Minimizing the dissolution of lead/copper is accomplished primarily by changing the water chemistry to favor the formation of a protective layer on the pipe walls.

Forming a protective layer on the pipe wall interrupts the flow of electrons by eliminating either the cathode or the anode, or both. Also, changing the water chemistry can make the water less effective in conducting electricity.

CORROSION CELL

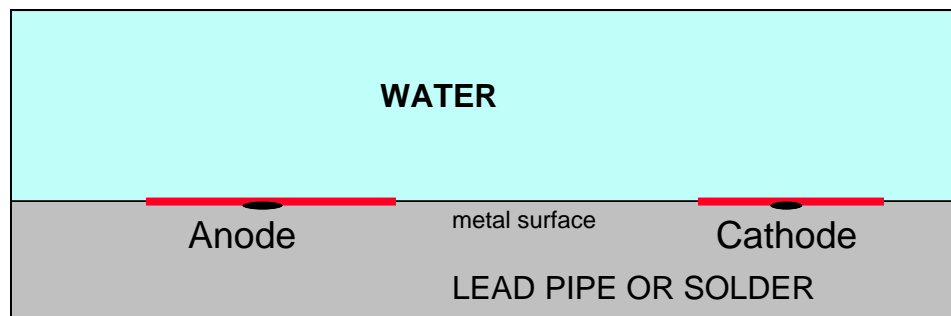

LCR CCT ALTERNATIVES:

1. pH/alkalinity adjustment
2. Calcium hardness adjustment (calcium carbonate precipitation)
3. Corrosion inhibitors

LCR CCT Alternative #1: pH/Alkalinity Adjustment

- pH/alkalinity adjustment accomplishes this by **raising the pH and forming metal compounds on the pipe surface** that are less soluble than the pipe material.
- If the pipe is copper, copper compounds are formed on the pipe that keep the copper from dissolving. If the pipe is lead, or if there are lead solder joints, lead compounds are formed.
- pH/alkalinity adjustment involves adding a **base** or similar chemical to the water to increase pH to a level where the lowest practical lead or copper solubility is achieved.
- pH/alkalinity adjustment changes the chemistry of the water so that the metal in the distribution system or plumbing forms compounds with the **carbonate** in the water.

In pH/alkalinity adjustment, lead forms **lead carbonate-hydroxide** compounds and copper forms **copper carbonate-hydroxide** compounds.

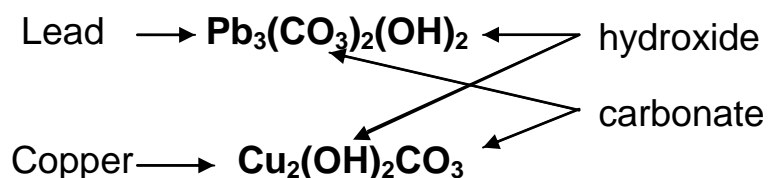

These compounds form a protective layer on the pipe wall that interrupts the flow of electricity in the corrosion cells.

- The objective of pH/alkalinity adjustment is to neutralize carbonic acid and form the insoluble metal compounds.

THE CARBONATE SYSTEM

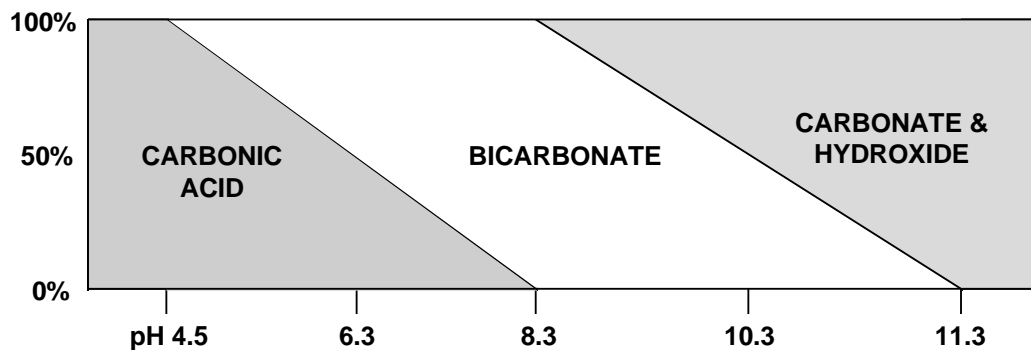

Example: A water system exceeded the lead action level. The pH of the system's raw water is 6.0.

At pH = 6.0 raw water probably contains mostly **carbonic acid**, which makes the water corrosive.

If we add a base, the carbonic acid will be converted to **bicarbonate** as the pH increases.

If we continue to add more chemical, some of the bicarbonate will be converted to **carbonate and hydroxide**.

Carbonate and hydroxide are the compounds needed to combine with the lead to form the desired insoluble compound.

For many systems, pH/alkalinity adjustment involves operating at fairly high pH's, often as high as 8.5 or above.

Pb Solubility vs. pH

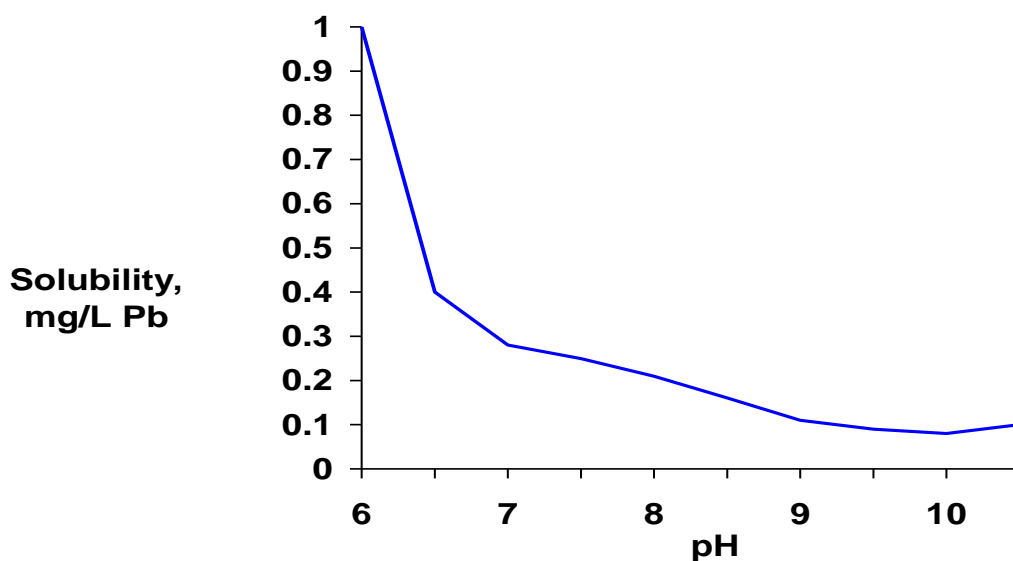

- This graph shows an example of the effect of pH on lead solubility under laboratory conditions.¹
- As pH increases above 6.0, lead solubility, or the **amount of lead** dissolving in the water, **decreases**.
- For effective lead reduction, many systems will need to adjust pH to the 8.0 - 8.5 range or above.
- **Caution:** Under certain raw water conditions, adding a chemical to raise pH may cause calcium carbonate to precipitate in the distribution system.

¹ This graph was developed from information in "Lead Control Strategies," AWWARF, pages 122 and 123. The pH and lead solubility points were obtained from the solubility curves shown as Figures 6.5 and 6.6 at a DIC of 12 mg/L as C.



Operator Tips:

pH/Alkalinity Adjustment Considerations for Lead

- It is the simplest type of corrosion treatment (adding one chemical).
- The approach is to add a **base** to the water to increase pH to reduce lead solubility.
- The operator should maximize reduction of lead considering other treatment such as disinfection, disinfection byproducts or iron removal.
- The key to success is to maintain a stable pH after treatment.
- Raising pH may cause CaCO_3 to precipitate.
- If a system has exceeded **both** lead and copper, treatment should focus on lead reduction. Copper levels will usually be lowered also.

If a system has exceeded the copper action level only, the following operator tips should be considered.



Operator Tips:

pH/Alkalinity Adjustment Considerations for Copper

- It is the simplest type of corrosion treatment.
- pH is the most important factor.
- 98% of copper problems can be solved by pH adjustment.
- pH should not be less than 7; above a pH of 8.0 is best for copper reduction.

Langelier Saturation Index (LSI)



Langelier Saturation Index (LSI) - The LSI is based on the effect of pH on the solubility of calcium carbonate (CaCO_3). When water is exactly saturated with CaCO_3 , it will neither dissolve nor deposit CaCO_3 . Water is considered stable when it is just saturated with calcium carbonate. The calcium carbonate is in equilibrium with the hydrogen ion concentration.

$$\text{LSI} = \text{pH} - \text{pH}_s$$

Where pH = actual pH of the water, and

pH_s = pH at which water having the same alkalinity and calcium content is just saturated with calcium carbonate

- If the pH is raised from the equilibrium point (pH_s), the water becomes scale forming and will deposit calcium carbonate.
- If the pH is lowered from the equilibrium point (pH_s), the water turns corrosive.

LSI Values	Effect on Water
LSI greater than 0	Water is supersaturated and tends to precipitate a scale layer of CaCO_3
LSI = 0	Water is saturated (in equilibrium) with CaCO_3 a scale layer of CaCO_3 is neither precipitated nor dissolved.
LSI less than 0	Water is under saturated, tends to dissolve solid CaCO_3

LCR CCT Alternative #2: Calcium Carbonate Precipitation

- Precipitation forms a layer of calcium carbonate (CaCO_3) precipitate that coats the pipe.
- Like pH/alkalinity adjustment, you add a base or similar chemical - caustic soda, lime, soda ash, or sodium bicarbonate - to increase pH.
- Some systems that are trying to control corrosion using pH adjustment will precipitate calcium carbonate. This may occur when the raw water chemistry has some or all of these characteristics:
 - Low pH (below 6.5)
 - High carbon dioxide levels (above 20 mg/L)
 - Moderate or higher alkalinity (above 100 mg/L)
 - Moderate or higher calcium hardness (above 50 mg/L)

Systems that precipitate significant amounts of calcium carbonate in attempting to adjust pH are the systems that will probably have to use precipitation as their treatment.

LCR CCT Alternative #3: Corrosion Inhibitors

Depending upon the raw water quality parameters, it may be more practical to add an inhibitor than to adjust pH. You may want to add an inhibitor if:

- The raw water pH is in the optimal range for inhibitors.
- You have iron and manganese problems.
- You want to minimize TTHM formation potential. (Increasing pH requires an increased chlorine dosage which contributes to the formation of TTHMs.)
- Inhibitors are specially formulated chemicals that form a protective layer on the pipe wall.

- **Phosphates** are by far the most common inhibitors used in water treatment for corrosion control.

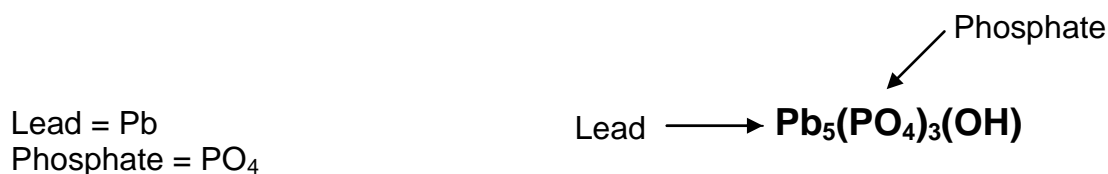

- When a phosphate inhibitor is used for corrosion control, the protective coating is formed from the pipe metal combined with the phosphate.
- The control of lead using a phosphate inhibitor occurs when a **lead-phosphate** compound is formed.
- **Orthophosphates are primarily** used to control lead, not copper.
- Under optimal conditions, orthophosphate treatment is usually **more effective in reducing lead** levels than pH/alkalinity adjustment alone.

Let's look at the operator tips for orthophosphate treatment.



Operator Tips for Orthophosphate Treatment

- Stable pH is necessary to maintain protection.
 - Optimal pH is 7.2 to 7.8.
 - Alkalinity should be at least 20 mg/L for pH control.
 - Orthophosphate residual must be maintained in the distribution system.
- Systems that have raw water naturally in the optimal pH range of 7.2 to 7.8 can treat with orthophosphate alone, provided the water has sufficient alkalinity for a stable pH.
 - If pH and/or alkalinity are not in the optimal ranges, pH/alkalinity adjustment is needed in addition to the inhibitor.

Treatment Summary for pH/alkalinity Adjustment and Corrosion Inhibitors

Treatment Approach	Key Water Quality Parameters	Appropriate Chemical Feed Systems
pH/alkalinity adjustment	pH, alkalinity, temperature	Caustic Soda Lime Soda Ash Sodium Bicarbonate
Corrosion Inhibitors	pH, alkalinity, temperature, metals, hardness, inhibitor residual	Orthophosphate Polyphosphate Ortho-poly blends Silicates

- The key water quality parameters for pH/alkalinity adjustment are pH, alkalinity and temperature.
- The most widely used chemicals for this treatment are caustic soda, lime, soda ash, and sodium bicarbonate.
- For corrosion inhibitor treatment, in addition to pH and alkalinity, metals and hardness are important because they may tie up some of the inhibitor and reduce its effectiveness.
- The inhibitor concentration itself is a crucial parameter.
- The three common phosphate inhibitors are orthophosphates, polyphosphates, and ortho/poly blends.
- Silicates are much less common than phosphates, but may be suitable for small systems with iron and manganese problems.



Unit 2 Corrosion Principles and Theory Key Points:

- Electron movement in water causes electricity which makes water corrosive to metals like lead and copper.
- When placed in water, acids produce hydrogen ions; bases produce hydroxide ions.
- pH is a measure of how acidic or basic a water is.
- Adding an acid to water decreases its pH; adding a base increases pH.
- One goal of corrosion control involves raising pH to neutralize carbonic acid.
- Corrosion of pipes occurs because an electrochemical cell is formed.
- The chemistry of the water has the greatest effect on corrosion.
- CCT under the LCR is intended to minimize the dissolution of lead/copper into tap water.
- Controlling lead/copper is achieved by forming a protective layer on the pipe wall that eliminates the corrosion cell.
- For most systems with lead/copper corrosion, pH/alkalinity adjustment is the treatment of choice.
- pH/alkalinity adjustment is the simplest treatment - adding a chemical to raise pH.
- For systems with copper problems only (no lead problems), adjust pH above 8.0.
- Corrosion inhibitors should be used when pH adjustment alone is insufficient or raw water is naturally in the optimal pH range for the inhibitor.
- Orthophosphates are by far the most widely used inhibitors for lead control.
- The Langelier Saturation Index (LSI) is a calcium carbonate (CaCO_3) saturation index. LSI values greater than 0 indicate a scaling potential (i.e., precipitating) whereas LSI values less than 0 indicate water dissolves CaCO_3 .
- Calcium carbonate precipitation is not a recommended treatment unless pH adjustment and inhibitors are not feasible.
- Corrosion control treatment requires pH control and finished water stability to be effective.

**Exercise for Unit 2 – Corrosion Principles and Theory**

Circle the correct answer.

1. When placed in water, acids/bases produce hydrogen ions; acids/bases produce hydroxide ions.
2. A _____ is the product of combining an acid and a base.
3. A finished water pH value of 5.0 indicates:
 - a. Water is basic
 - b. Water is acidic
 - c. Water may corrode pipes and fittings
 - d. Both a and c
 - e. Both b and c
4. What objectives can be met with corrosion control treatment?
 - a. Minimize amount of lead and/or copper dissolving into tap water.
 - b. Maximize the service life of plumbing materials.
 - c. Improve the hydraulic characteristics of water distribution systems.
 - d. All of the above.
5. Controlling lead/copper is achieved by forming a protective layer on the pipe wall that eliminates the corrosion cell.

a) True b) False
6. What does a Langelier Saturation Index of 1.1 indicate?
 - a. Scaling potential
 - b. Dissolving potential
7. If an operator adjusts the pH of the finished water above the saturation point for calcium carbonate, this will create a protective coating on the pipe wall.

a) True b) False

8. Determine how the addition of the following chemicals to water will affect pH and complete the table.

If I add:		The pH will be _____ (raised/lowered)
potassium hydroxide	KOH	
nitric acid	HNO ₃	
lime	Ca(OH) ₂	
sulfuric acid	H ₂ SO ₄	
caustic soda	NaOH	
soda ash	Na ₂ CO ₃	
hydrochloric acid	HCl	

Unit 3 – Corrosion Control Chemicals

Learning Objectives

- Identify the common pH/alkalinity adjustment chemicals used for corrosion control treatment.
- Identify the common chemical names, chemical characteristics, and operational considerations.
- Review the impacts and constraints of pH/Alkalinity chemicals or CaCO₃ precipitation.
- Identify the common corrosion inhibitors and review fact sheets for each type of inhibitor.
- Review the impacts and constraints of inhibitors.

pH Adjustment treatment

- pH is the major factor that determines the solubility of most pipe materials.
- Most common method of reducing corrosion in water distribution systems.
- Most easily implemented and least costly.
- pH adjustment alone is often insufficient in waters that are low in carbonate and bicarbonate alkalinity.

Alkalinity



Alkalinity: The capacity of water to neutralize acids. This capacity is caused by the water's content of bicarbonate, carbonate and hydroxide.

- A system's ability to maintain stable water chemistry seems to be influenced by the alkalinity concentration of its water.
- Generally, alkalinity should be 20 mg/L or above to give sufficient buffering (prevent pH from changing). Without sufficient buffering, pH control is very difficult.
- The amount of alkalinity in the source (raw) water is generally not a problem unless the alkalinity is low.
- Alkalinity is needed to provide anions, such as (OH) for forming insoluble compounds to precipitate them out. Alkalinity can be naturally present or may need to be added.
- Sodium bicarbonate (Bicarbonate Soda) will make water more alkaline. It can be used when you only want to increase the alkalinity.
- pH adjustment chemicals may also increase alkalinity. Therefore, alkalinity may be increased by the addition of lime, caustic soda or soda ash.

Common Chemical Names

Table 3.1 - Common pH/Alkalinity Adjustment Chemicals

Chemical Name	Chemical Formula	Common Name
Sodium Hydroxide	NaOH	Caustic Soda
Calcium Hydroxide	Ca(OH) ₂	Lime
Sodium Bicarbonate	NaHCO ₃	Baking Soda
Sodium Carbonate	Na ₂ CO ₃	Soda Ash

Do these chemicals act like acids or bases? _____

Are caustic soda and lime stronger or weaker bases than soda ash or sodium bicarbonate? _____

Chemical Characteristics

Table 3.2 - Summary of Chemicals Typically Used in pH/Alkalinity and Calcium Adjustment Corrosion Control Treatment

Chemical	Use	Notes
Caustic Soda	Raise pH. Convert excess CO ₂ to alkalinity species	pH control is difficult when applied to low alkalinity water (<20 mg/L) no increase in calcium adds sodium
Lime	Raise pH. Increases alkalinity and calcium content	Slurry feed can cause excess turbidity O & M intensive
Sodium bicarbonate	Increases alkalinity with little increase in pH	Good alkalinity adjustment choice, but very expensive adds sodium
Soda ash	Increases alkalinity with moderate increase in pH	More pH increase caused as compared to sodium bicarbonate, but less costly adds sodium

As you can see from the table:

- Caustic soda, lime, and soda ash raise pH and may increase alkalinity.
- Sodium bicarbonate is primarily used to increase alkalinity.
- Caustic soda causes the pH to rise dramatically and quickly when alkalinity is low.
- Lime requires more operational attention than other chemicals.



Operator Tips: Lime

- Use flexible pipelines to break CaCO₃ deposits.
- Minimize length of line by placing feeder as close as possible to point of application.

Operational Considerations

Table 3.3 - Operational Considerations for pH/Alkalinity Adjustment Chemicals

Chemical	Available Forms	Feed Equipment	Storage	Safety Considerations
Caustic Soda	50% or 25% solution	Proportioning pump or rotameter	50% solution requires heated storage room to prevent freezing	dangerous to handle protective clothing, rubber gloves, rubber apron, face shield, goggles control mists with good ventilation
Lime	powder in 50 or 100 lb bags; bulk	Hydrated lime-solution tank, and feed pump with erosion-resistant lining as eductor	Dry storage with slurry feed	positive ventilation, protective clothing, gloves, face shield, neck cloth, respirator
Sodium Bicarbonate	powder; 25 lb drums, 100 lb bags	Solution tank, proportioning pump or rotameter	Dry storage with solution feed	positive ventilation, protective clothing, gloves, goggles, respirator
Soda Ash	powder in 50 and 100 lb bags; bulk	Solution tank, proportioning pump or rotameter	Dry storage with solution feed	positive ventilation, protective clothing, gloves, goggles, respirator

- Lime, sodium bicarbonate, and soda ash are delivered as dry chemicals but are fed as liquids.
- Soda ash and sodium bicarbonate are safe and easy chemicals to handle.
- Caustic soda is typically sold as a 25% or 50% solution.
- Caustic soda is dangerous to handle.
 - * Causes severe burns to skin and eyes and mucous membranes
 - * Causes severe lung damage if dust, mist or spray is inhaled
 - * Reacts violently with water, acids, and other substances

Recently, 20 people sought medical attention for skin, eye, and throat irritations after caustic soda was accidentally released into a water system in a southwest Florida community. About 8,000 gallons of water containing high levels of caustic soda was supposed to be flushed away, but instead was released into the city's water supply.

- If this happened as a result of ingesting water, just imagine how much harm you could do to yourself by handling it improperly.
- If you are using caustic soda, pay special attention to the MSDS sheet, which is located in the Appendix.

Here's more information about how to protect yourself if you are using caustic soda.

Personnel Safety Protection for Caustic Soda

Basic Equipment

- Safety protection equipment for sodium hydroxide is similar to equipment used for other corrosive chemicals.
- Equipment must be used and maintained in strict accordance with manufacturers' recommendations and instructions.
- Protective clothing includes:
 - Eye protection. (goggles, full-face shield)
 - Chemical-Resistant Gloves.
 - Impervious protective clothing and/or rubber apron.
- Emergency showers and eye-wash stations should be provided.



Figure 3.1 An Emergency Shower



Figure 3.2 An Eye Wash Station

First Aid

Inhalation

- Remove the injured party and take person(s) to fresh air.
- Call for medical assistance.

Skin Contact

- Immediately shower with large quantities of water.
- Remove protective clothing and equipment while in the shower.
- Flush the skin with water for at least 15 minutes.
- Call for medical assistance.

Eye Contact

- **Immediately** shower with large quantities of water while holding eyes open for at least 15 minutes.
- Call a physician immediately.
- Transfer person(s) promptly to a medical facility.

Ingestion

- **DO NOT INDUCE VOMITING.**
- Give 2 glasses of water.
- Call a physician immediately.
- Transfer person(s) promptly to a medical facility.



Operator Tips: Caustic Soda

- Because 50% caustic soda precipitates out at temperatures below 60° F, you must keep the storage room and feed lines warm.
- When mixing caustic soda with water, always add caustic slowly to the water, **NEVER ADD WATER** to concentrated caustic.

One final comment about chemical products: be sure to check each shipment you receive to make sure you are actually getting the percent strength you are ordering. For instance, check to see if your caustic soda is 50%. This information will be found on the invoice or MSDS sheet.

There are impacts and constraints when using pH/alkalinity chemicals.

Impacts and Constraints of pH/Alkalinity Adj. or CaCO₃ Precip.

1. Reduces inactivation effectiveness of free chlorine if pH is raised before disinfection.***
2. May increase turbidity from post-filtration precipitation of lime, aluminum, iron, or manganese.
3. High trihalomethane (THM) concentrations from chlorination if pH is raised before disinfection.
4. Raising pH levels before the coagulation process reduces the effectiveness of alum and poly aluminum chloride. For example, increasing the pH above 7.0 before the coagulation process hinders turbidity removal and may increase the aluminum concentration in the finished water.

It is preferable to adjust pH levels after coagulation. Otherwise, a different coagulant should be used that will work effectively at higher pH levels.

5. Reduced effectiveness of some coagulants for THM precursor removal if pH is raised before coagulation.
6. Potential for higher total plate counts, confluent growth, or presence of total coliform when chlorination is practiced.
7. Removal of radionuclides during softening may be linked to the degree of softening. Modifying softening practices to achieve corrosion control could interfere with removals.

8. The use of sodium-based chemicals will increase total sodium levels in the finished water
9. Excessive calcium carbonate precipitation may produce “white water” problems in portions of the distribution system
10. It may be difficult to produce an acceptable coating of calcium carbonate on interior piping for large distribution systems. Too much coating may lead to reduced hydraulic capacities in lines near the treatment facility, whereas too little coating may not provide adequate corrosion protection in the extremities of the distribution system.
11. Users with specific water quality needs, such as health care facilities, should be advised of any treatment changes

***Unless operating restraints dictate otherwise, the optimum location for pH adjustment is after disinfection and near the entrance to the distribution system. If lime is used to adjust pH, for example, it needs to be added prior to filtration so inert material does not accumulate in the clearwell or enter the distribution system.

The final type of LCR CCT alternative involves protecting the inside of the pipe with an inhibitor.

Phosphate Inhibitors

There are many types of phosphate compounds.

- Phosphate inhibitors develop a very thin protective insoluble metallic film on the inside of the pipes. These films may only be 1 molecule thick. This is how we control lead.
- They are used to control scale build up.

There are advantages and disadvantages to using phosphate inhibitors as opposed to the other two types of treatment.

Advantages

In comparing the use of inhibitors to pH adjustment or CaCO_3 precipitation, the advantages include:

- Unlike CaCO_3 precipitation, film does not build up and consequently flow and pump efficiencies remain high.
- Taste, odor, alkalinity and pH are not affected; hardness not increased.
- Finished water pH is lower; therefore, chlorine doses and TTHM formation potential may be lower than with pH adjustment.

Disadvantages

Phosphate inhibitors do have a few disadvantages.

- They may encourage algal growth in reservoirs exposed to sunlight.
- Phosphates can act as fertilizers on bacterial growth in distribution systems so you need to maintain adequate chlorine residuals.
- Zinc is often added to enhance phosphate performance; however, wastewater treatment plants have sludge disposal problems due to the elevated zinc levels.



Operator Tips: Inhibitors

- The choice of particular type of phosphate depends on the specific water quality.
- Compositions are proprietary so the chemical distributor establishes dosage rates and minimum inhibitor concentrations in the distribution system.
- Some phosphate feed programs should include:
 - * Cleaning mains by flushing or with hydraulic pigs. (A process that removes severe tuberculation and slime build up by brushing or scraping.)
 - * Pre-treating for a short term with high dosages. Systems may see an increase in color and cloudiness during this phase. Flushing hydrants will help to clear loosened deposits.
 - * Maintaining continuous feed. (Interrupting feed makes corrosion worse.)



Sequestration refers to a chemical complexing (forming or joining together) of metallic cations (such as iron) with certain inorganic compounds, such as phosphate. Sequestration prevents the precipitation of the metals (iron).

Inhibitor Fact Sheets

Polyphosphates

Polyphosphates are sequestering agents. They keep iron, manganese and calcium in solution thereby preventing the formation of precipitates that could deposit scale or cause discoloration.

Another term that you may hear or read about is “bimetallic.” Phosphates are typically sodium or potassium based. Zinc is added as the second metal. It enhances polyphosphates by forming a film faster and increases the effective pH range.

Use:

polyphosphates control scale
sequester iron, manganese, and calcium

Available Forms:

They can be purchased as a liquid, granular, or glassy form

Examples: C-2 (liquid pyrophosphate) **RS-2 (dry blend of poly)
 C-5 (liquid polyphosphate) *TG-10 (glassy zinc poly)
 **C-6 (granular zinc metaphosphate)
 V937 (granular zinc metaphosphate)
 Nalco 7393 (zinc polyphosphate)

Suitable Materials for Handling:

Corrosion-resistant materials such as: polyethylene, fiberglass, or epoxy or vinylester lined steel for storage tanks, feed systems and piping.

For pump liquid ends and piping: PVC, CPVC, Kynar, 316 stainless steel, viton or hypalon.

Storage/Feed Considerations:

Solution drums or day tanks should be located in a **heated** building or use **heat-traced tank** to prevent freezing; keep liquid container closed when not in use.

Dry storage (granular or glassy forms) should be on pallets in a cool, dry area to avoid moisture absorption.

Polyphosphate feed points should be separated from the chlorine injection point by as much distance as possible. The polyphosphate feed point should also be prior to the chlorine injection point. This gives the polyphosphate enough time to sequester the iron and manganese. If polyphosphate is fed after the chlorine, there is a possibility that the iron and manganese will be oxidized by the chlorine before the sequestering action can take place causing iron and manganese precipitates to be pumped out into the distribution system.

*TG-10 requires an electric mixer and dissolving tank

**C-6 and RS-2 require vigorous mechanical stirring

Safety Equipment Required: Use goggles and gloves when handling the chemical, especially glassy forms. Glassy forms have sharp edges.

Notes:

- Polyphosphates degrade to orthophosphates depending on time and temperature.
- pH conflict exists between sequestering iron and manganese which requires a pH of less than 7 vs. lead/copper control which requires a pH of greater than 7.
- Bimetallic polyphosphates often perform better than other polyphosphates in the following ways:

- * with lower dosages
- * in more mineralized and harder water
- * extend their effectiveness to a pH of at least 8

Orthophosphates

Orthophosphates are very effective in reducing lead levels. Orthophosphates rapidly form an insoluble metal film.

Use:

Orthophosphates are used primarily to control lead.
They do not sequester.
They are not very effective at reducing copper levels

Available Forms:

Most orthophosphates are delivered as liquids in plastic drums, disposable liquid bins, and bulk.

Examples: C-9 (liquid zinc ortho) C-14 (liquid zinc ortho)
 C-9L (liquid zinc ortho) C-15 (liquid zinc ortho)
 C-10 (liquid zinc ortho) V932 (liquid zinc ortho)
 C-11 (liquid zinc ortho)

Suitable Materials for Handling:

Corrosion-resistant materials such as: polyethylene, fiberglass or epoxy or vinylester lined steel for storage tanks, feed systems and piping.

For pump liquid ends and piping: PVC, CPVC, Kynar, 316 stainless steel, viton or hypalon

Storage/Feed Considerations:

Orthophosphates also require a **heated** building or **heat-traced** tank to prevent freezing; keep liquid container closed when not in use.

Safety Equipment Required: Because orthophosphate solutions are very low pH (<1.0), you should wear goggles or a face shield, gloves, and protective clothing when handling these chemicals.

Notes:

- most effective when a stable pH between 7.4 and 7.8 is maintained
- intended for low hardness waters (below 50 mg/L total hardness)

- low alkalinity water may require pH stabilization for optimal lead and copper reduction.
- need to prevent CaCO₃ scale precipitation in high alkaline water because they contain little or no scale inhibition properties. As hardness and alkalinity increase, orthophosphate deposits form which disrupt the supply of inhibitor.

Ortho/Poly Blends

As the title implies, these compounds are blends of both ortho and polyphosphates. They sequester and form films.

Use:

They are used when you need to sequester iron and manganese in addition to reducing lead and copper levels.

Available Forms:

They are available as a liquid which can be delivered in plastic container or in bulk

Examples: Aqua Mag (liquid sodium ortho/polyphosphate)
C-4 (liquid blended phosphate)

Storage/Feed Considerations:

Store product in a clean dry area protected from freezing and extreme heat.
Keep container closed when not in use.

Suitable Materials for Handling: PVC, teflon, polyethylene, stainless steel

Safety Equipment Required: goggles

Notes:

- Varying proportions of sodium and potassium phosphates in portions that vary from 10 - 30% ortho to polyphosphate ratio.
- They are dependent upon reacting with calcium to form a calcium orthophosphate protective film.
- Exhibit tubercle and scale removal properties.
- Initial increased high passivation dosage not needed.
- Operate best in pH range of 7.2 to 7.8

Silicates

Silicate inhibitors are produced by fusing sodium carbonate with silica sand. Silicates form a metal silicate barrier on top of and interlattice with a metal hydroxide structure.

Uses:

Lead and Copper control
 Fe/Mn removal
 point-of-use for buildings and industrial processes

Available Forms:

known as “water glass”;
 liquid delivered in plastic drums or bulk

Examples: PQ Corporation N[®] Silicate (liquid sodium silicate)
 PQ Corporation D[®] Silicate (for water pH < 6.0)

Storage/Feed Considerations:

Store product in a **heated** building to prevent freezing.
 Wet spills are slippery and dehydrate to form glass-like films; therefore, rinse minor spills with water immediately. Dried deposits may form sharp edges

Suitable Materials for Handling: For piping: PVC, carbon steel, stainless steel

Safety Equipment Required: Goggles or face shield, alkali-resistant gloves

Notes:

- limited use in Pennsylvania
- best when raw water is in the pH range between 8 and 9.5
- no scale properties
- process is self-limiting; requires corrosion products to form and stops when corrosion products are no longer available
- protection is lost if dosage is stopped
- higher cost than phosphate inhibitors
- less effective in stagnant water

Just a reminder, like pH/alkalinity chemical shipments, be sure to verify that the inhibitor that you are receiving is the correct one. For instance, if you are using C-9L, make sure that's what you receive.

There are some impacts and constraints when using inhibitors.

Impacts and Constraints of Inhibitors

1. Phosphate-based inhibitors may stimulate biofilms in the distribution system; the biofilms may deplete disinfectant residuals within the distribution system.
2. Consumer complaints regarding red water, dirty water, color, and sediment may result from the action of the inhibitor on existing corrosion byproducts within the distribution system.
3. The use of zinc orthophosphate may present problems for wastewater facilities with zinc or phosphorus limits in their NPDES permits.
4. Users with specific water quality needs, such as health care facilities, should be advised of any treatment changes
5. The use of sodium-based chemicals will increase total sodium levels in the finished water
6. The use of silicates may reduce the useful life of domestic hot water heaters due to “glassification”; silicates precipitate rapidly at higher temperatures.
7. For systems using alum or other products containing aluminum: if aluminum breakthrough occurs, the aluminum will bind with the orthophosphate at a ratio of 1:4 and interfere with maintaining an effective inhibitor film. This means that 1 part of aluminum will bind 4 parts of orthophosphate. According to the Calgon Corporation, orthophosphate that is “bound” with aluminum will still create an orthophosphate residual, but the part that is bound won’t be contributing to the corrosion control treatment coating. (For example, if your target orthophosphate residual is 0.5 mg/l and you have 0.1 mg/l of aluminum, only 0.1 mg/l of the orthophosphate will be used to coat your pipes while 0.4 mg/l will be bound to the aluminum.) To account for this problem, aluminum readings should be taken at the entry point, multiplied by 4 and added to the operating orthophosphate residual to obtain an effective residual of orthophosphate needed for corrosion control in the system.



Unit 3 Corrosion Control Chemicals

- Caustic soda, lime and soda ash are common pH adjustment chemicals and they may also increase the alkalinity of the water.
- Sodium bicarbonate is used primarily to adjust alkalinity.
- Caustic soda is dangerous to handle because contact with caustic soda may cause damage to skin and eye tissue. Consequently, operators should use a face shield, rubber gloves and a rubber apron as protective clothing.
- Phosphate inhibitors develop a very thin protective insoluble metallic film on the inside of the pipes which won't clog the pipes.
- Phosphate inhibitors may encourage algal growth in reservoirs exposed to sunlight.
- When using phosphate inhibitors, you must maintain continuous feed because interrupting feed makes corrosion worse.
- Zinc orthophosphates are used primarily to control lead levels but are not as effective for copper.
- Ortho/poly blends should be used when you need to sequester iron and manganese in addition to reducing lead levels.
- When the pH is raised before disinfection, the inactivation effectiveness of free chlorine is reduced.
- To maximize the **sequestering** effectiveness of polyphosphates, the polyphosphates should be added prior to chlorination.



Exercise for Unit 3 – Corrosion Control Chemicals

1. List the common names for the following pH/alkalinity adjustment chemicals:

<u>Chemical Name</u>	<u>Common Name</u>
Calcium hydroxide	_____
Sodium carbonate	_____
Sodium hydroxide	_____

2. When using caustic soda, it is necessary to have at least 20 mg/L of alkalinity to maintain a stable pH.

- a) True
- b) False

3. It is not necessary to minimize the length of line for a lime feeder.

- a) True
- b) False

4. Which type of inhibitor is used to control lead?

- a) Polyphosphate
- b) Silicates
- c) Orthophosphate

5. When the pH is raised before disinfection, the inactivation effectiveness of free chlorine is increased.

- a) True
- b) False

6. When using polyphosphates to **sequester** iron and manganese, why should the chemical feed point should be located **before** the disinfection process?

References

Water Treatment Plant Operation Volume I, Third Edition, 1994.

AWWA Corrosion Control for Operators, AWWA, 1986.

Unit 4 – Chemical Feed

Learning Objectives

- Identify the components of a liquid chemical feed equipment system.
- Describe liquid chemical feed system Operation and Maintenance activities
- Identify the components of a dry feed chemical feed equipment system.
- Describe dry fee chemical feed system Operation and Maintenance activities
- Perform calculations for the following types of situations:
 - ✚ Mixing a Percent Solution
 - ✚ Determining Weight of % Solution Using Specific Gravity
 - ✚ Dry and Liquid Feed Rate Calculations
 - ✚ Calculating the “active ingredient” weight of a % Solution
- Describe the steps in developing a pump calibration curve

Components of a Liquid Chemical Feed System

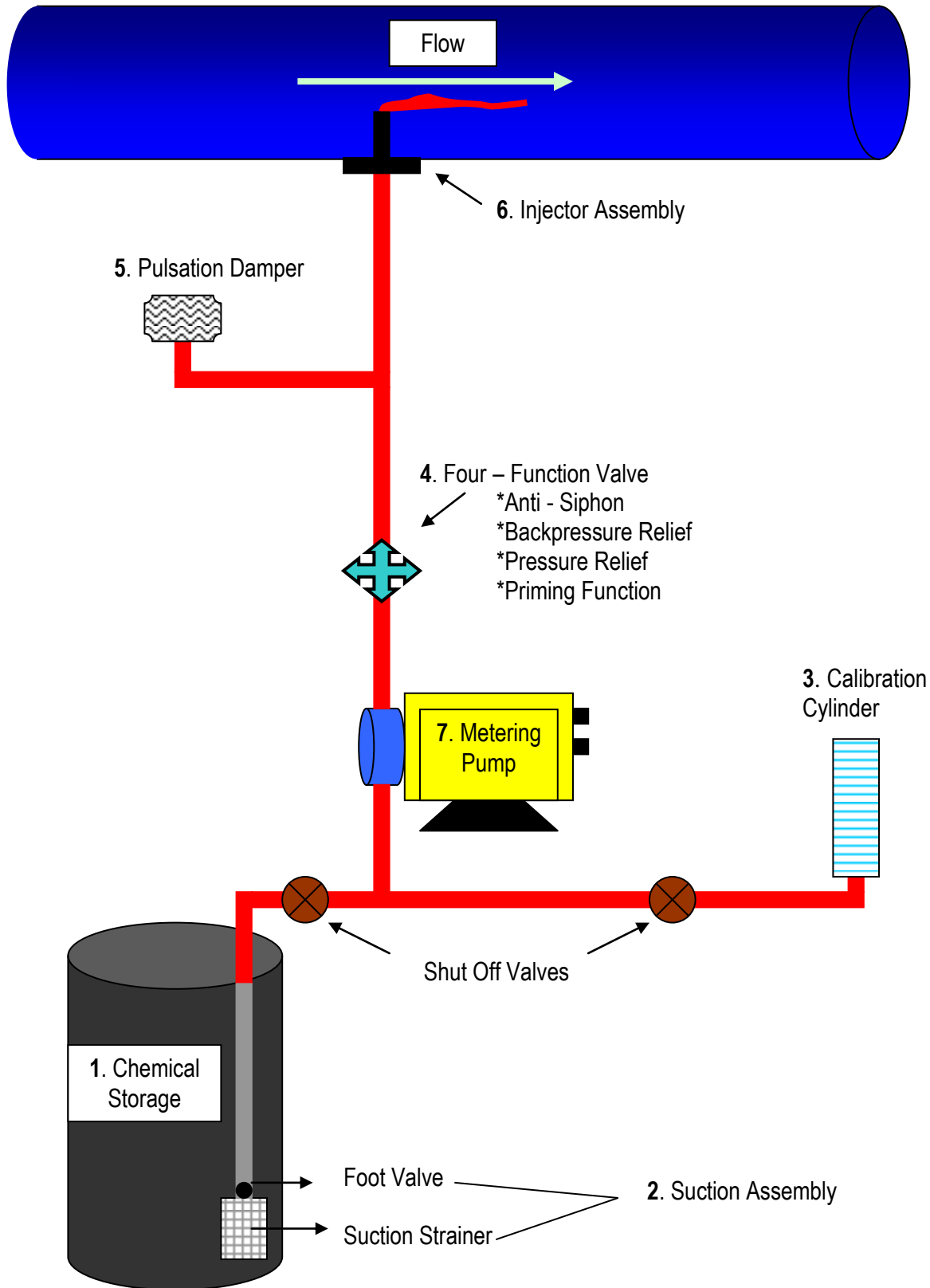

Figure 4.1

Description of Components of a Liquid Chemical Feed System

1. **Chemical Storage Containers** – Chemicals that are shipped from the manufacturer may be stored in containers that have many different shapes and sizes depending on the type and amount of chemical that was shipped. Primarily there are two types of storage containers used; one would be a chemical drum and the other might be a chemical storage tank.
 - A. The chemical drum is used primarily when the solution is fed neat (undiluted).
 - B. A day tank is used to store, dilute and mix chemicals.
 1. All chemical storage tanks should have some type of measuring device to let the operator know the amount of chemical that is in the storage tank at all times.
 2. Chemical spill containment should be provided to contain accidental spills of chemicals.
 - a. Spill containment areas should be large enough to contain a spill of 110% of the largest single container.
 - b. Containment areas should contain leak detection equipment to provide an alarm in the event of a chemical spill.
2. **Suction Assembly** – Should be suspended just above the bottom of the tank so as not to pull in any solids that might have settled to the bottom of the tank. The suction assembly consist of:
 - A. Suction Strainer – A strainer is used to protect the internal components of the pump.
 - B. Foot Valve – This is a check valve that is used to prevent the pump from losing prime.
3. **Calibration Cylinder** – A calibration cylinder consists of a graduated cylinder typically located on the suction side of the pump. It is used for accurate determination of the pump's feed rate.
4. **4-Function Valve** - A valve can be used to not only control flow, but the rate, the volume, the pressure or the direction.

COMPONENTS OF A LIQUID FEED SYSTEM

- A. **Pressure relief valve** – When line pressure exceeds the set pressure, the diaphragm moves the valve stem off the seat of a pressure relief valve and dissipates the excess pressure.
 - B. **Backpressure Valve** – A backpressure valve consists of an adjusting spring loaded diaphragm. It maintains a steady backpressure to ensure accurate delivery. Additionally, a backpressure valve prevents over pumping when little or no backpressure is present.
 - C. **Anti-Siphon Valve** – Negative pressures can be produced in normally pressurized lines due to power failures, draining of lines, inadvertent valve operation or fouled check valves. The anti-siphon valve prevents siphoning of the chemical storage tank into the distribution system when negative pressure is produced.
 - D. **Priming Function** – Simple way to prime your pump.
5. **Pulsation Dampener** – This is meant to offset surges created by the pulsating discharge pressure encountered when using either a piston or diaphragm metering pump. This helps a system combat water hammer (clanging of pipes caused by a change in direction of flow when a pump shuts off or a valve is closed).
6. **Injector Assembly** - The art of chemical injection is complex.
- A. Installation is determined by the chemical being fed. And the order of chemical addition is important and should be specific to your system.
 - B. Location of the assembly is important for proper mixing. In order to assure proper mixing, the discharge point should be located in the middle of the flow. However, it also needs to be placed so it does not become clogged with passing debris that may be in the system.
7. **Liquid Chemical Feed Pump** – Pumps are made up of 2 major components; the drive assembly (motor) which provides power for the pumping action and the liquid end which is the area through which the solution is pumped. Positive displacement pumps are used to pump a measured dose of liquid chemical into a treatment system. While there are several types of positive displacement pumps, the most common:
- A. **Peristaltic Pump** – Used for pumping a variety of fluids. The fluid is contained within a flexible tube fitted inside a circular pump casing.

- B. Diaphragm Pump – Used to pump a variety of fluids and is more common than a peristaltic pump. Measures a liquid volume ensuring accurate delivery of a chemical solution.



Liquid Chemical Feed System Operation and Maintenance:

Proper design is important for a successful feed system but there is something that is even more critical: Operation and maintenance of feed systems. Chemical feed systems will give years of trouble free operation if the following factors are considered:

1. Observe all operating components daily.
2. Maintain a regular schedule of maintenance on all equipment as per the manufacturer's recommendations.
3. Chemical metering pumps should be calibrated on a regular basis or when the operator suspects a problem with the pump.
4. Any leak throughout the system will cause a reduction in the amount of chemical solution pumped. All leaks must be repaired as soon as they are discovered.
 - a. If the pump appears to be operating, but the chemical feed is less than expected, suspect a ruptured diaphragm.
5. The suction assembly on a chemical metering pump should be inspected and cleaned on a regular basis as per the manufacturer's recommendations. A clogged assembly can be cleaned with a weak acid solution (i.e., vinegar or 1:1 HCl).
6. All components that contact the chemical solution that is pumped should be disassembled, cleaned and inspected as per the manufacturer's recommendations.
7. Pumps should be inspected regularly for signs of wear and damage. Wetted parts (ball valves, diaphragms) should be replaced on a regular basis.
8. A cracked diaphragm may leak chemical, damage the pump or cause the pump to lose prime.
9. A ball valve caked with chemical may stick and cause siphoning.

COMPONENTS OF A LIQUID FEED SYSTEM

10. A worn seal may form an air leak that could lower the pump output or cause the pump to lose prime.

Repairs or replacement should be made before the machine breaks down.

Dry Chemical Feed Systems

A dry feeder measures dry chemical and mixes it with water in a solution tank. The resulting solution is either pumped into the main water flow of the system or fed in using an ejector. An ejector system uses the Venturi effect to create a vacuum and moves the solution into the main water flow. The two basic types of dry feeders are volumetric and gravimetric feeders.

1. **Volumetric Dry Feeders** – Volumetric dry chemical feeders are usually simpler to use, less expensive to operate, less accurate dry feeders and feed a smaller amount of chemical. The operation of this type of system is fairly simple. The chemical is usually stored in a silo above the unit and each time the system needs to make a new batch of solution a feed mechanism (rolls or screws) deliver exactly the same volume of dry chemical to the dissolving tank with each complete revolution. Varying the speed of rotation varies the feed rate.

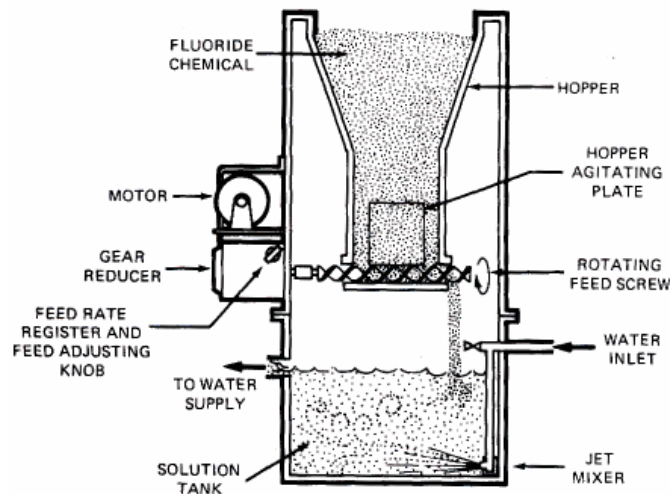

Figure 4.2

2. **Gravimetric Dry Feeders** – Gravimetric dry chemical feeders are extremely accurate and can be adapted to automatic controls and recording. However, they are more expensive than volumetric dry feeders. This is a belt-type feeder that delivers a certain weight of material with each revolution of the conveyor belt. Because gravimetric feeders control the weight of material, not the volume, variations in density have no effect on feed rate. This accounts for the extreme accuracy of this type of feeder.

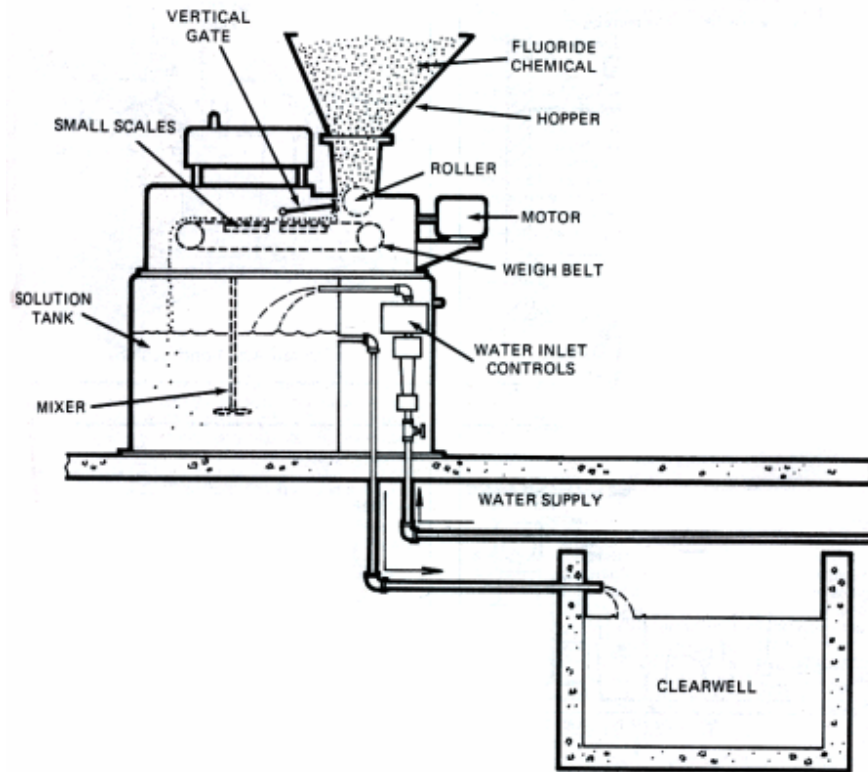

Figure 4.3

Dry Chemical Feed System Operation and Maintenance

1. Observe operating components daily.
2. Follow manufacturer's recommendations when performing maintenance.
3. These units are feeding fine powdery chemicals therefore cleaning and inspection of all moving parts should be conducted routinely.
4. After all preventative maintenance has been completed, proper calibration should be completed.

Dry Feeders

“Dry Chemical Solution Day Tanks”

A day tank is used to store a limited supply of diluted chemical solution to be fed into the treatment system. The solution in a day tank can be diluted to a specific concentration (strength). The solution consists of two parts: the solute and the solvent.

1. Solute: The dry product that you are adding or the amount of dry product in a concentrated solution.
2. Solvent: The liquid which is dissolving the solute.

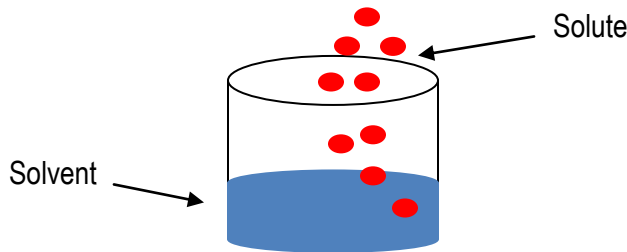

An operator needs to determine how many pounds of dry chemical is needed to be added (as the solute) into the day tank (solvent) to produce a chemical solution.

Mixing a Percent Solution

How many pounds of caustic soda are required to be mixed with 100 gallons of water to produce a 20% solution?

$$? \text{ lbs} = 8.34 \frac{\text{lbs}}{\text{gal}} \times \text{Volume (gal)} \times \% \text{ Strength Solution (either as a decimal or a fraction)}$$

$$? \text{ lbs} = 8.34 \frac{\text{lbs}}{\text{gal}} \times 100 \text{ gal} \times \frac{20}{100} \text{ (or 0.20 as a decimal)}$$

$$? \text{ lbs} = 8.34 \times 20 \text{ (because } 100 \div 100 = 1)$$

$$? \text{ lbs} = 166.8 \text{ lbs}$$

DRY CHEMICAL SOLUTION DAY TANK AND MIXING CALCULATION

Practice Problem: Mixing a Percent Solution

How many pounds of caustic soda are required to be mixed with 50 gallons of water to produce a 12% solution?

$$? \text{ lbs} = 8.34 \frac{\text{lbs}}{\text{gal}} \times \text{Volume (gal)} \times \% \text{ Strength Solution (either as a decimal or a fraction)}$$

$$? \text{ lbs} = 8.34 \frac{\text{lbs}}{\text{gal}} \times \underline{\quad} \text{ gal} \times \frac{\underline{\quad}}{100} \text{ (or } \underline{\quad} \text{ as a decimal)}$$

$$? \text{ lbs} = 8.34 \times \underline{50} \text{ (gal)} \times \underline{\quad} \text{ (% strength solution as a decimal)}$$

$$? \text{ lbs} = \underline{\quad} \text{ lbs}$$

Before we introduce feed rate calculations, let's review a few chemistry concepts.

Weight



Weight is the mass of an object being acted upon by gravity. The weight of an object is proportional to its mass.

- ◆ There is less gravitational force on the moon than on Earth; therefore, an object on the moon will weigh less than the same object on Earth. The mass of the object remains the same but the weight is different.

Density



Density is the mass of a substance per unit of volume of the substance. All matter has mass and volume; therefore, all matter has a density.

- ◆ Density is important because it can be used to relate how a solution compares to water.
- ◆ Density is expressed as a mass per volume, such as mg/L or lbs/gal and is calculated as follows:

$$\text{Density (d)} = \frac{\text{Mass (m)}}{\text{Volume (v)}}$$

Mass corresponds to the general, everyday notion of how "heavy" something is. In everyday usage, the **mass** of an object is often referred to as its **weight**.

Specific Gravity



Specific gravity is the weight or density of a substance compared to the weight or density of the same volume of water. **Water has a specific gravity of 1 (no units) at 4° C (39° F).**

$$\text{Specific Gravity} = \frac{\text{Weight or density of substance}}{\text{Weight or density of water}}$$

- ◆ Specific gravity is used to check chemical purity. It is also used to calculate volume for a given weight of chemical or to calculate weight for a given volume of chemical.
- ◆ Specific gravity can tell us if the material will sink or float in water. For example, a rock with a density of 4.3 g/cm³ will sink in water (density of 1.0 g/cm³), but a piece of plastic with a density of 0.8 g/cm³ will float in water.

Density of Water

- ◆ By definition, 1 Liter of water = 1 kilogram of mass, therefore:

$$\begin{aligned}\text{Density of water} &= 1,000 \text{ grams per } 1,000 \text{ milliliters} \\ &= 1,000 \text{ grams} / 1,000 \text{ ml} \\ &= 1 \text{ g/ml or } 1 \text{ g/cm}^3\end{aligned}$$

- ◆ Water has a density of 1 g/ml, 1 g/cm³ or 8.34 lbs/gallon. If you weigh a gallon of water, it will weigh 8.34 lbs. Likewise, if you weigh a milliliter of water it will weigh 1 gram.
- ◆ Substances with a greater density will displace those with less density. If a solution has a higher density than water, it will sink in the water; however, if a solution has a lower density than water, it will float on the water. For example, lead will sink in water but oil will float on the water.

Calculating Specific Gravity

- ◆ Specific gravity is calculated by comparing the weight of a given volume of a substance to the weight of the same volume of water.
- ◆ Water has a **density of 1 gram/milliliter (g/ml)** so its **specific gravity is equal to its density**.

Calculating the Weight of a Gallon of Chemical

- ◆ To calculate the weight of a gallon of a chemical, multiply the specific gravity of the chemical by the weight of a gallon of water.

Example 1: Calculate the weight of a gallon of 50% NaOH (sodium hydroxide or caustic soda), given that a 50% solution of caustic soda has a specific gravity of 1.53.

Weight of a substance, lbs/gal = (Specific gravity of substance) x (weight of a gallon of water)

Weight of 50% NaOH, lbs/gal = (1.53) x (8.34 lbs/gal)

Weight = A gallon of 50% solution of NaOH weighs 12.76 lbs

We'll use weight and specific gravity when we calculate liquid feed dosage rates later in this unit.

Jar testing is used to determine a chemical dosage. Once the chemical dosage has been determined, the feed rate can be calculated.



Feed Rate is the quantity or weight of chemical delivered from a feeder over a given period of time. A feed rate can have different units of expression, such as lb/day, lb/hr, lb/min, lb/sec, mg/L, or mg/min. Often, determining a feed rate involves time and weight conversions.



Flow Rate is the amount of water being treated daily at a facility. It is measured and reported in millions of gallons per day (MGD).

Chemical feed rate calculations involve four primary considerations:

1. **Chemical product strength (% purity)**
2. **Product feed rate (lbs/day)**
3. **Plant flow (MGD)**
4. **Dosage (mg/L).**

Dosage/Feed Rate Calculation

- To perform the calculation, you will need to know the amount of chemical being added and the amount of water being treated.

Feed Rate, lbs/day = Flow (MGD) x Dosage (mg/L) x 8.34 lbs/gal

This formula is represented in the following diagram called the Davidson Pie which was created by Gerald Davidson, Manager, Clear Lake Oaks Water District, Clear Lake Oaks, CA.

Davidson Pie

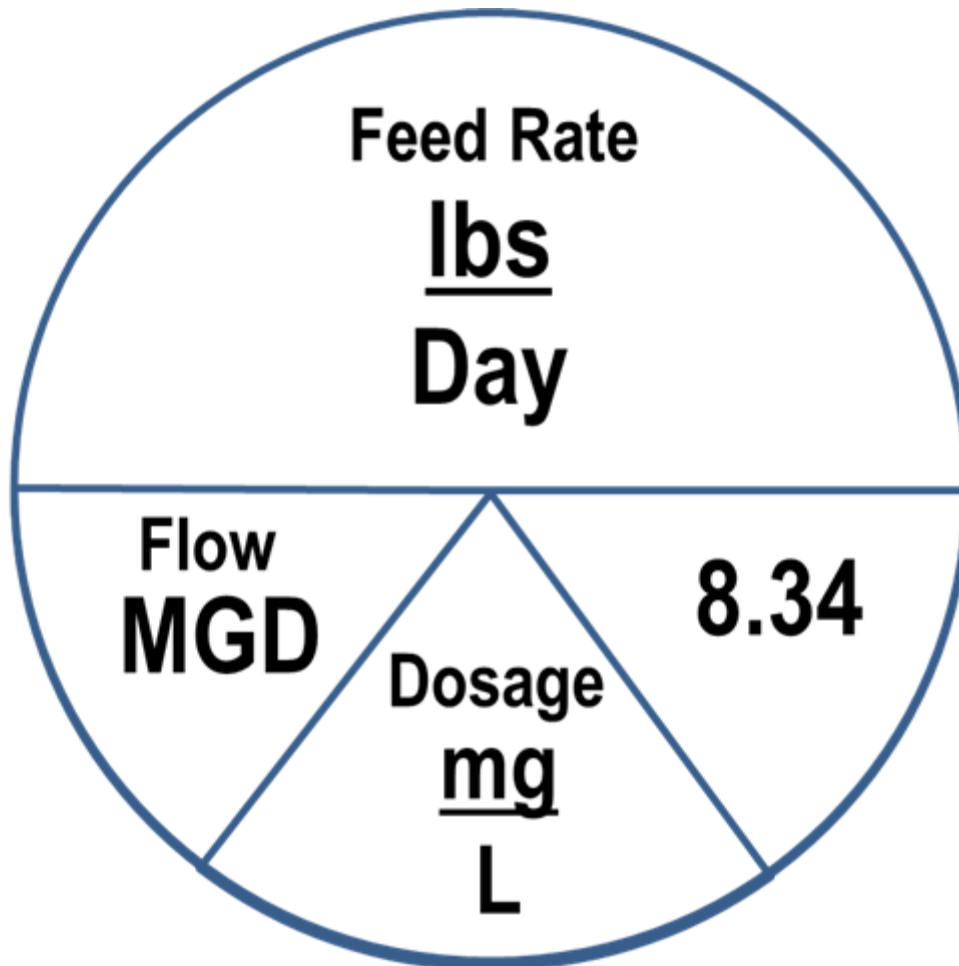

Key Acronyms:

MG = million gallons

MGD = million gallons per day

Davidson Pie Diagram Interpretation and Formulas

This diagram can be used to solve for 3 different results: dosage, feed rate, and flow (or volume).

As long as you have 2 of those 3 variables, you can solve for the missing variable.

Davidson Pie Interpretation

Middle line = divided by (\div)

Bottom diagonal lines = multiply by (\times)

In other words, here are the 3 equations that can be used with these variables:

1. **Feed Rate, lbs/day = Flow (MGD) or Volume (MG) \times Dosage (mg/L) \times 8.34** (which is the density of water)
2. **Flow (MGD) = lb/day \div (Dosage, mg/L \times 8.34)**

$$\text{Vertical Format: Flow(MGD)} = \frac{\text{Feed Rate (lbs/day)}}{[\text{Dosage (mg/L)} \times 8.34]}$$

3. **Dosage (mg/L) = lb/day \div (Flow, MGD \times 8.34)**

$$\text{Vertical Format: Dosage (mg/L)} = \frac{\text{Feed Rate (lbs/day)}}{[\text{Flow(MGD)} \times 8.34]}$$

We'll only need to focus on the first and most commonly used equation that solves for feed rate in lbs/day.

Dry Feed Rate Calculation

$$\text{Feed Rate, Pounds per day} = \text{flow(MGD)} \times \text{dose(mg/L)} \times (8.34)$$

This equation alone (without extra steps) can be used to solve for feed rates of 100% strength chemicals, such as lime or soda ash.

A water treatment plant produces 3 million gallons per day, and uses lime, dosed at 17 mg/L, how many pounds per day will the plant will use?

$$\text{Feed Rate, Pounds per day} = 3 \times 17 \times 8.34 = 425.34 \text{ pounds per day}$$

When you have a flow in gallons per minute (GPM) or gallons per day (GPD), you will need to convert those values into million gallons per day (MGD) before using the feed rate formula.

Converting from GPM to MGD before solving with the formula

Problem: A water treatment plant operates at the rate of 75 gallons per minute. They dose soda ash at 14 mg/L. How many pounds of soda ash will they use in a day?

We'll use unit cancellation to show the steps involved in doing this math.

Step 1: Convert gallons per minute into gallons per day using unit cancellation.

$$? \frac{\text{gal}}{\text{day}} = 75 \frac{\text{gal}}{\text{minute}} \times \frac{60 \text{ minutes}}{\text{hour}} \times \frac{24 \text{ hours}}{\text{day}} = 108,000 \frac{\text{gallons}}{\text{day}}$$

Step 2: Convert gallons per day into million gallons per day (MGD) using unit cancellation.

$$? \frac{\text{MG}}{\text{day}} = 1 \frac{\text{MG}}{1,000,000 \text{ gallons}} \times \frac{108,000 \text{ gallons}}{\text{day}} = 0.108 \text{ MGD}$$

Positions the numerator

Step 3: Use MGD in feed rate formula to solve for lbs/day

$$\text{Feed Rate, Pounds per day} = \text{flow(MGD)} \times \text{dose(mg/L)} \times (8.34)$$

$$0.108 \times 14 \times 8.34 = 12.61 \text{ lbs/day}$$

CHEMICAL FEED RATE CALCULATIONS: DRY FEED

Steps 1 and 2 can be combined like this:

Step 1: Convert gallons per minute into million gallons per day (MGD) using unit cancellation.

$$? \frac{\text{MG}}{\text{day}} = 1 \frac{\text{MG}}{1,000,000 \text{ gallons}} \times 75 \frac{\text{gal}}{\text{minute}} \times \frac{60 \text{ minutes}}{\text{hour}} \times \frac{24 \text{ hours}}{\text{day}} = 0.108 \frac{\text{MG}}{\text{day}}$$

You can also use the conversion of 1 day = 1440 mins (60 X 24) to remove 2 conversions. (minutes/hour and hours/day)

Step 1: Convert gallons per minute into million gallons per day (MGD) using unit cancellation.

$$? \frac{\text{MG}}{\text{day}} = 1 \frac{\text{MG}}{1,000,000 \text{ gallons}} \times 75 \frac{\text{gal}}{\text{minute}} \times \frac{1440 \text{ minutes}}{\text{day}} = 0.108 \frac{\text{MG}}{\text{day}}$$

Dry Feed Practice Problem

How many pounds of lime are needed for a desired dosage of 17 mg/L when the average daily plant flow is 200 gpm?

Step 1: Convert flow (in gallons) into MGD so that the feed rate (lbs) formula can be used.

$$? \frac{\text{MG}}{\text{day}} = \frac{1 \text{ MG}}{1,000,000 \text{ gal}} \times 200 \frac{\text{gal}}{\text{min}} \times \frac{1440 \text{ mins}}{\text{day}} \text{ gal} = \underline{\hspace{2cm}} \text{ MGD}$$

Step 2: Solve for pounds per day (feed rate) for 100% pure chemical (no impurities).

$$? \text{ lbs} = \text{volume(MG)} \times \text{dose(mg/L)} \times 8.34 = (\underline{\hspace{2cm}})(17)(8.34) = \underline{\hspace{2cm}} \text{ pounds of lime is required.}$$

Let's discuss liquid feed calculations and the extra steps we need to take to calculate the feed rate.



Active Strength is the percentage of a chemical or substance in a mixture that can be used in a chemical reaction. (also referred to as % purity)

- ❑ Active strength of liquid chemicals must be known.
 - Different strength chemicals can be purchased.
 - Caustic Soda commercially available at 25 to 50% NaOH

Liquid Feed Rate Calculations Using Flow with a % Strength (i.e., % pure) Solution

Liquid feed solutions are not 100 percent pure. For example, the caustic soda typically used is 50% pure. That means that out of every gallon of caustic soda, only 50% is the active strength component, and the other material (50%) is not active.

Example Problem: A water plant uses 50% caustic soda to provide pH adjustment to the water. The target dose is 32 mg/L. The plant flow is 347 gpm. How many pounds of caustic soda will the system use?

Step 1: Convert flow (in gallons) into MGD so that the feed rate (lbs) formula can be used.

$$?MG = \frac{1 \text{ MG}}{1,000,000 \text{ gal}} \times 347 \frac{\text{gal}}{\text{min}} \times 1440 \frac{\text{mins}}{\text{day}} \text{ gal} = \underline{0.499 \text{ MGD}}$$

Step 2: Solve for pounds per day (feed rate) for 100% pure chemical (no impurities).

Using the formula pounds per day = flow x dose x 8.34 = (0.499)(32)(8.34) = 133 pounds of "pure" caustic soda is required.

Step 3: Calculate # of pounds of 50% solution needed to achieve Step 1 feed rate.

Since they are using caustic soda, and only 50% of the caustic soda is "pure", we need to calculate how many pounds of 50% caustic soda solution are required to get 133 pounds of "pure" product. To do that we need to change the percent to a decimal, and divide that into the pounds required.

a) Convert % purity of solution into a decimal:

$$\frac{50 \%}{100\%} = 0.50$$

b) Then divide the pounds needed (feed rate of 100% pure chemical) by the % purity of the solution (as a decimal).

$$\frac{133 \text{ pounds}}{0.5 (\% \text{ purity as a decimal})} = 266 \text{ pounds of 50\% caustic soda.}$$

CHEMICAL FEED CALCULATIONS: LIQUID FEED

TIP: Answer will always be more pounds than Step 1 result because solution is not 100% pure. In this case, solution is only 50% pure.

Liquid Feed Rate Practice Problem: A water plant uses 25% caustic soda to raise the pH of the water. The target dose is 20 mg/L. They treat 600 gpm. How many **pounds** of caustic soda will need to be fed?

Step 1: Convert flow (in gallons) into MGD so that the feed rate (lbs) formula can be used.

$$? \text{MG} = \frac{1 \text{ MG}}{1,000,000 \text{ gal}} \times \left(\frac{\quad}{\quad} \right) \frac{\text{gal}}{\text{min}} \times 1440 \frac{\text{mins}}{\text{day}} \text{ gal} = \text{ ______ } \text{MGD}$$

Step 2: Solve for pounds per day (feed rate) for 100% pure chemical (no impurities).

Using the formula pounds per day = flow x dose x 8.34 = (______)(20)(8.34) = ______ pounds of "pure" caustic soda.

Step 3: Calculate # of pounds of 25% solution needed to achieve Step 2 feed rate.

a) Convert % purity of solution into a decimal:

$$\frac{25 \%}{100\%} = \text{ ______ }$$

b) Then divide the pounds needed (feed rate of 100% pure chemical) by the purity of the solution (as a decimal).

$$\frac{144 \text{ pounds}}{0.25 \text{ (\% purity as a decimal)}} = \text{ ______ } \text{ pounds of 25\% caustic soda.}$$

TIP: Answer will always be more pounds than Step 2 result because solution is not 100% pure.

CALCULATING THE WEIGHT OF THE “ACTIVE INGREDIENT” OF A % SOLUTION

Calculating “Active Ingredient” Weight

In addition to knowing that solutions are not 100% pure (i.e. 100% active), we also need to determine the weight of the active strength ingredients within that solution.



Active ingredient weight is the number of pounds of “active ingredient” per gallon of a % solution that cause a chemical reaction.

- This “active ingredient” weight value is then used in a calculation with the 100% pure “lbs/day” feed rate to determine the “gal/day” feed rate.

Calculating the Weight of the “Active ingredient” of a % Solution Chemical

EXAMPLE: How many pounds of caustic soda are there in a gallon of caustic soda that is 25% pure that has a specific gravity of 1.28?

Step 1: Solve weight equation (lbs/gal) for 1 gallon of chemical

Weight, lbs/gal = (Specific gravity of substance) x (weight of a gallon of water)

$$1.28 \quad \times \quad 8.34 \frac{\text{pounds}}{\text{gallon}} = 10.67 \frac{\text{pounds}}{\text{gallon}}$$

Step 2: Determine the “active ingredient” weight of the caustic soda based on the % purity of solution

a) Convert % purity of solution into a decimal:

$$\frac{25\%}{100\%} = 0.25$$

b) Multiply the weight of a gallon (from step 1) by the % purity of the product (as a decimal).

$$10.67 \frac{\text{pounds}}{\text{gallon}} \times 0.25 = 2.66 \text{ pounds of caustic soda in a gallon of 25\% caustic soda solution}$$

This “active ingredient” weight provides the pounds of available caustic soda that is found in each gallon of 25% caustic soda solution. Within the 10.67 pounds of 25% caustic solution, there are 2.66 pounds of active ingredients.

CALCULATING THE WEIGHT OF THE “ACTIVE INGREDIENT” OF A % SOLUTION

Practice Problem: Calculating the “Active Ingredient” Weight of a % Solution Chemical

EXAMPLE: How many pounds of caustic soda are there in a gallon of caustic soda that is 50% pure that has a specific gravity of 1.53?

Step 1: Solve weight equation (lbs/gal) for 1 gallon of chemical

Weight, lbs/gal = (Specific gravity of substance) x (weight of a gallon of water)

$$1.53 \quad \times \quad \frac{8.34 \text{ pounds}}{\text{gallon}} = \frac{\quad \text{pounds}}{\text{gallon}}$$

Step 2: Determine the “active ingredient” weight of the caustic soda based on the % purity of solution

a) Convert % purity of solution into a decimal:

$$\frac{50\%}{100\%} = \frac{\quad}{\quad}$$

b) Multiply the weight of a gallon (from step 1) by the % purity of the product (as a decimal).

$$12.76 \frac{\text{pounds}}{\text{gallon}} \times 0.5 = \frac{\quad \text{pounds}}{\text{gallon}} \text{ of caustic soda in a gallon of 50\% caustic soda solution}$$

This “active ingredient” weight provides the pounds of active strength ingredients that are found in each gallon of 25% caustic soda solution. Within the 12.76 pounds of 50% caustic solution, there are 6.38 pounds of active ingredients.

There is a Corrosion Control Chemical table found in the Appendix that shows this “active ingredient” weight of 6.38 lbs/gallon for 50% caustic soda.

The active ingredient weight is a “lb/gal” rate that can be used to convert the 100% pure “**lbs/day**” feed rate into a “**gal/day**” feed rate.

USING THE “ACTIVE INGREDIENT” WEIGHT TO CONVERT TO GALS/DAY

Using “Active Ingredient” Weight to Convert Feed Rate from lbs/day to gals/day

Liquid Feed Rate Example Problem: A water plant uses 25% caustic soda to raise the pH of the water. The target dose is 20 mg/L. They treat 600 gpm. Specific gravity of 25% caustic soda is 1.28. How many **gallons** of caustic soda will need to be fed?

Step 1: Solve weight equation (lbs/gal) for 1 gallon of chemical

Weight, lbs/gal = (Specific gravity of substance) x (weight of a gallon of water)

$$1.28 \times \frac{8.34 \text{ pounds}}{\text{gallon}} = 10.67 \frac{\text{pounds}}{\text{gallon}}$$

Step 2: Determine the “active ingredient” weight of the caustic soda based on the % purity of solution

a) Convert % purity of solution into a decimal:

$$\frac{25\%}{100\%} = 0.25$$

b) Multiply the weight of a gallon (from step 1) by the % purity of the product (as a decimal).

$$10.67 \frac{\text{pounds}}{\text{gallon}} \times 0.25 = 2.66 \text{ pounds of caustic soda in a gallon of 25\% caustic soda solution}$$

Step 3: Convert flow (in gallons) into MGD so that the feed rate (lbs) formula can be used.

$$? \text{MGD} = \frac{1 \text{ MGD}}{1,000,000 \text{ gal}} \times \frac{(600) \text{ gal}}{\text{min}} \times \frac{1440 \text{ mins}}{\text{day}} = 0.864 \text{ MGD}$$

Step 4: Solve for pounds per day (feed rate) for 100% pure chemical (no impurities).

Using the formula lbs/day = flow x dose x 8.34 = $(0.864)(20)(8.34) = 144$ pounds of “pure” caustic soda.

Step 5: Use unit cancellation to convert lbs/day to gals/day

$$? \frac{\text{gal}}{\text{day}} = \frac{1 \text{ gallon}}{2.66 \text{ lbs}} \times \frac{144 \text{ lbs}}{\text{day}} = 54.1 \frac{\text{gals}}{\text{day}} \text{ of 25\% caustic soda}$$

USING THE “ACTIVE INGREDIENT” WEIGHT TO CONVERT TO GALS/DAY

Liquid Feed Rate Practice Problem: A water plant uses 50% caustic soda to raise the pH of the water. The target dose is 30 mg/L. They treat 500 gpm. Specific gravity of 50% caustic soda is 1.53. How many **gallons** of caustic soda will need to be fed?

Step 1: Solve weight equation (lbs/gal) for 1 gallon of chemical

Weight, lbs/gal = (Specific gravity of substance) x (weight of a gallon of water)

$$1.53 \times 8.34 \frac{\text{pounds}}{\text{gallon}} = \underline{\hspace{2cm}} \frac{\text{pounds}}{\text{gallon}}$$

Step 2: Determine the “active ingredient” weight of the caustic soda based on the % purity of solution

a) Convert % purity of solution into a decimal:

$$\frac{50\%}{100\%} = \underline{\hspace{2cm}}$$

b) Multiply the weight of a gallon (from step 1) by the % purity of the product (as a decimal).

$$12.76 \frac{\text{pounds}}{\text{gallon}} \times 0.5 = \underline{\hspace{2cm}} \text{ pounds of caustic soda in a gallon of 50\% caustic soda solution}$$

Step 3: Convert flow (in gallons) into MGD so that the feed rate (lbs) formula can be used.

$$? \text{MGD} = \frac{1 \text{ MGD}}{1,000,000 \text{ gal}} \times (\underline{\hspace{1cm}}) \frac{\text{gal}}{\text{min}} \times 1440 \frac{\text{mins}}{\text{day}} = \underline{\hspace{1cm}} \text{ MGD}$$

Step 4: Solve for pounds per day (feed rate) for 100% pure chemical (no impurities).

Using the formula lbs/day = flow x dose x 8.34 = ()(30)(8.34) = pounds of “pure” caustic soda.

Step 5: Use unit cancellation to convert lbs/day to gals/day

“Active ingredient”
weight of 50%
caustic soda solution

Feed Rate of “100% pure” caustic soda

$$? \frac{\text{gal}}{\text{day}} = 1 \frac{\text{gallon}}{\underline{\hspace{1cm}} \text{ lbs}} \times \frac{180 \text{ lbs}}{\text{day}} = \underline{\hspace{2cm}} \frac{\text{gals}}{\text{day}} \text{ of 50\% caustic soda}$$

The final step in feed rate calculations involves chemical feed pump settings.

Chemical Feed Pump Settings

Feed Rate is the quantity or **weight** of chemical delivered from a feeder over a given period of time. The chemical feed pump must be calibrated to **deliver the selected dosage**. A feed rate can have different units of expression, such as lb/hr, lbs/day, mg/L, mL/min, or gal/day. Often, determining a feed rate involves weight and time conversions.

Pump calibration is the process of measuring and recording the output at each dial setting. Once the data is recorded, it offers a quick reference for adjusting the feed rate in response to varying water quality or chemical demand.

- Feed pumps are calibrated with the use of a pump calibration curve.
- A new pump calibration curve should be constructed:
 - At least once per year.
 - If troubleshooting points to the need for a new pump calibration.
 - If any maintenance is performed on the pump.

For start-up, an operator would construct a calibration curve for the full range of percent stroke settings (20-100%) to determine the optimal pump setting.

The optimal setting would take into account:

- The dosage required.
- The manufacturer's recommendations for minimum and maximum settings.
- The linearity of the "curves". A more linear (straight) curve is better.

Once the appropriate percent stroke setting has been determined, future calibration would only involve the speed range (20-100) at that percent stroke.

Steps in Developing a Pump Calibration Curve

Step 1: Determine actual feed pump output.

- Operate feed pump over full operating range
- Determine actual pump output

Here's an example of the type of data you would collect for each stroke setting (20 – 100%)

LIQUID FEED PUMP CALIBRATION TABLE

% Stroke: _____

PUMP SETTING	VOLUME (mL)	TIME (min)	FEED RATE (mL/min)
20			
40			
60			
80			
100			

Here's an example of a completed liquid feed pump calibration table.

Stroke 60% Pump Calibration Table				
Pump Setting (%)	Alum Pumped (ml)	Time (sec)	Feed Rate (ml/min)	Feed Rate (gal/day)
0	0.0	30	0.00	0.000
20	65.6	55	71.56	27.2
40	141.9	59	144.31	54.8
60	249.1	61	245.02	93.1
80	195.2	32	366.00	139.1
100	267.4	35	458.40	174.2

Figure 4.4 Liquid Feeder Pump Calibration Table

Unit Cancellation Steps to Convert mL/min to gal/day:

$$\frac{? \text{ gal}}{\text{day}} = 1 \frac{\text{gal}}{3785 \text{ mL}} \times 71.56 \frac{\text{mL}}{\text{min}} \times 1440 \frac{\text{mins}}{\text{day}} = 27.22 \frac{\text{gal}}{\text{day}}$$

Step 2: Develop feed pump calibration curve.

- Plot each **Feed Rate (mL/min)** vs. **Pump Speed setting** on the graph.
- Connect each of the points together with a straight line.

PUMP: _____ PUMP CALIBRATION CURVE DATE: _____

% Stroke: _____

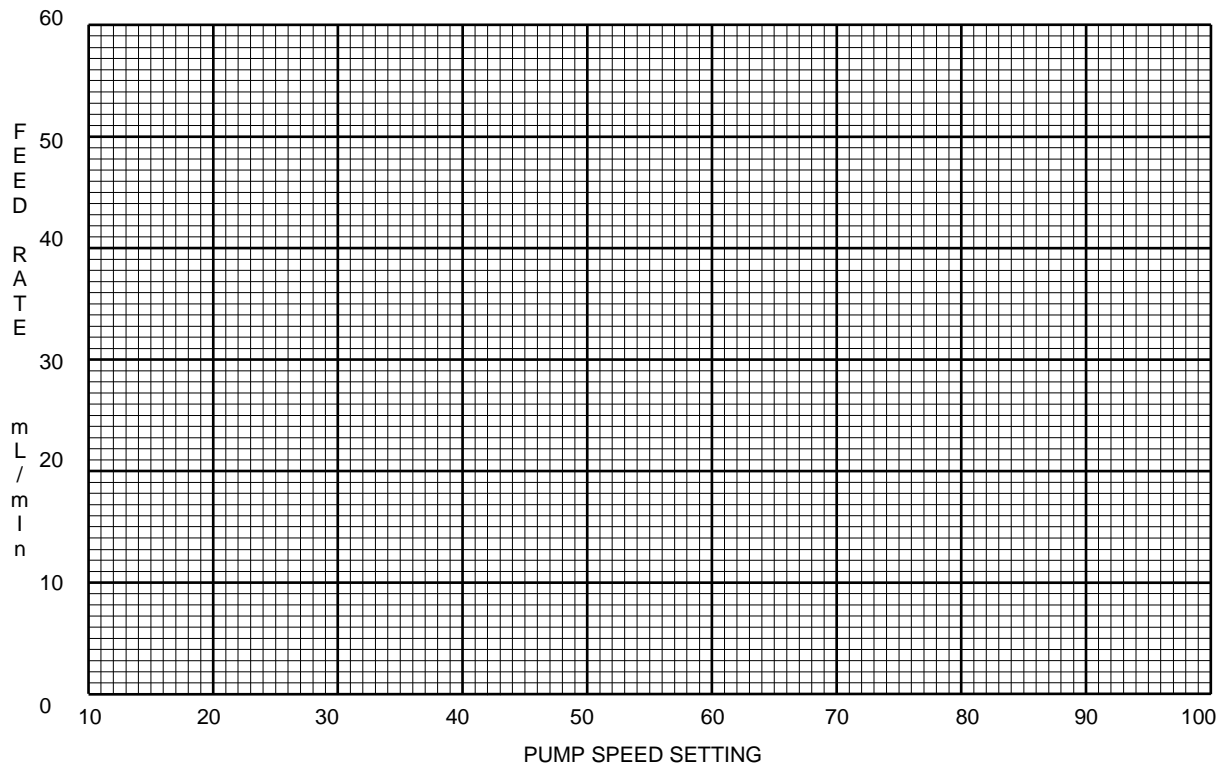

You can also change the feed rate from mL/min to **gal/day** by using this equation:

Insert the feed rate data (mL/min) for each pump setting (20 – 100) from the calibration table



$$\begin{array}{ccccccc}
 ?\text{gal} & = & 1 \text{ gal} & \times & 71.56 \text{ mL} & \times & 1440 \text{ mins} & = & 27.22 \text{ gal} \\
 \text{day} & & 3785 \text{ mL} & & \text{min} & & \text{day} & & \text{day}
 \end{array}$$

Here's the pump calibration curve for the data from Figure 4.4 on page 4-25.

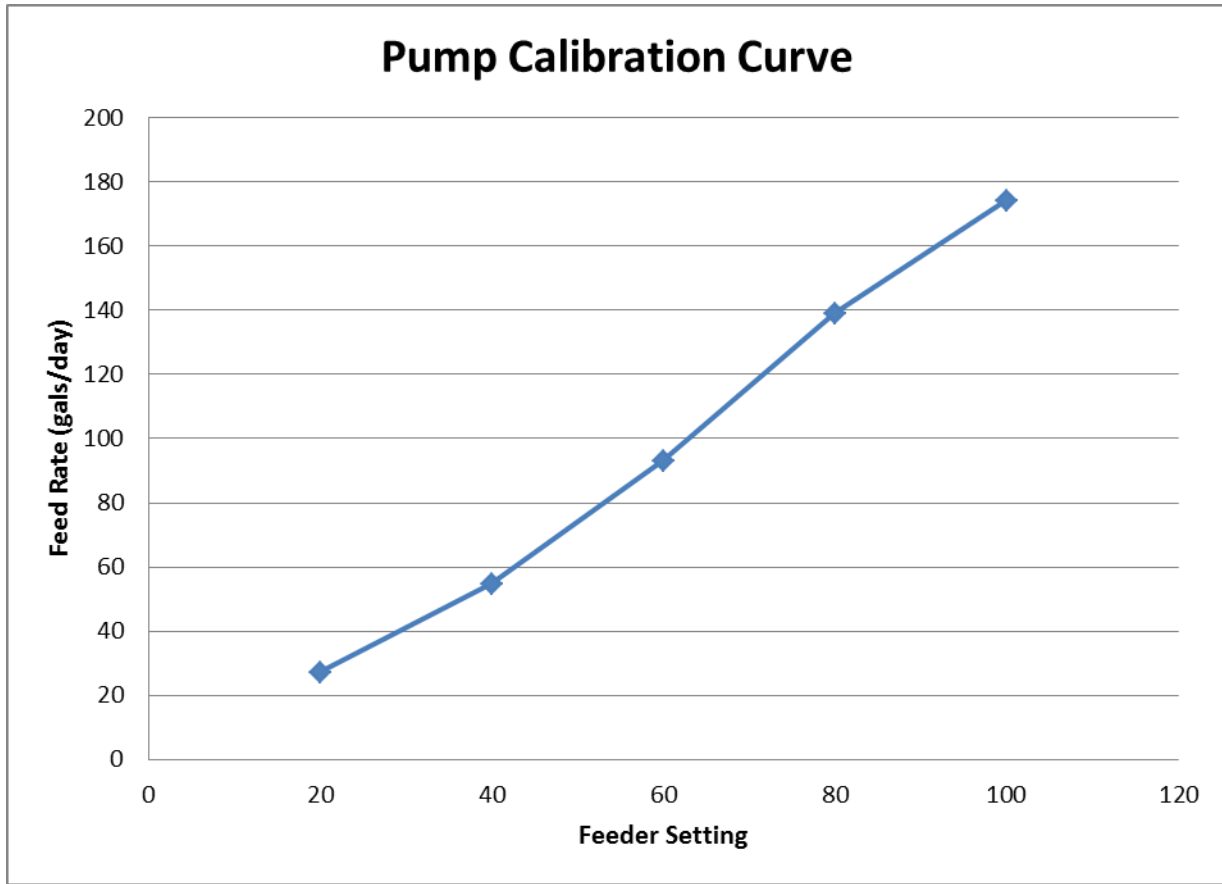

Figure 4.5 – Feeder Calibration Curve for Stroke 60%



Operator Tips: Pump Calibration

- Pump calibration is conducted to determine the pump's feed rate.
- A pump calibration curve is constructed to serve as a quick reference should the pump setting need to be adjusted in response to varying water quality or chemical demand.
- The pump speed setting equals the number of strokes per minute. A pump calibration should run for at least 50 strokes at each setting.
- If a calibration curve is constructed in ascending (increasing) order and a decrease in pump output is required, the pump control dial(s) should be turned down below the desired setting and then slowly increased to the appropriate setting. Q: Why? (Pump output is different going up the scale than it is going down the scale. Output from 30 - 40 is different than 40 - 30.)

Some of you might be familiar with a formula used to determine the theoretical pump output.

Take a look at the formula in your workbooks.

$$\text{PUMP OUTPUT} = \text{MAXIMUM PUMP OUTPUT} \times \% \text{ SPEED} \times \% \text{ STROKE}$$

The maximum pump output can be found on the data plate on the pump control panel.

For example, if a 24 GPD pump is set at 80% stroke length and 100% speed, the theoretical pump output would be:

$$24.0 \frac{\text{gal}}{\text{day}} \times .80 \times 1.0 = 19.2 \frac{\text{gal}}{\text{day}}$$

And, if we convert this to mL/min:

$$? \frac{\text{mL}}{\text{min}} = 3785 \frac{\text{mL}}{1 \text{ gal}} \times 19.2 \frac{\text{gal}}{\text{day}} \times \frac{1 \text{ day}}{1440 \text{ min}} \times = 50.5 \frac{\text{mL}}{\text{min}}$$

This formula should only be used as an estimate. The values are accurate only when the pump is brand new and under ideal conditions.

Because the output will change with wear and tear on the pump, pump calibration is still the most accurate tool used to determine the pump's output.

Step 3: Select the pump setting from all the % stroke calibration tables that provides the calculated feed rate.

The optimal pump setting would take into account:

- The dosage required.
- The manufacturer's recommendations for minimum and maximum settings.
- The linearity of the "curves". A more linear (straight) curve is better.

Once the appropriate percent stroke setting has been determined, future calibration would only involve the speed range (20-100) at that percent stroke.



Key points for Unit 4 Chemical Feed Components and Pump Calibration

- Corrosion chemicals storage containers consist of a chemical drum when the solution is fed neat (undiluted) or a day tank that may be used to store, dilute or mix chemicals.
- To contain accidental spills, spill containment areas should be large enough to contain a spill of 110% of the largest single container.
- A calibration cylinder, located on the suction side of the pump, is used for accurate determination of the pump's feed rate.
- In order to assure proper mixing, the discharge point of the injector assembly should be located in the middle of the flow of the pipe.
- Follow manufacturer's recommendations for maintenance of all liquid and dry feed system equipment.
- When mixing a percent solution for a day tank, use the following equation:

$$? \text{ lbs} = 8.34 \frac{\text{lbs}}{\text{gal}} \times \text{Volume (gal)} \times \% \text{ Strength (either as decimal or a fraction)}$$
- Specific gravity is the weight or density of a substance compared to the weight or density of the same volume of water. Substances with specific gravities greater than 1 will sink in the water. Substances with specific gravities less than 1 will float in water.
- Chemical feed rate calculations involve 4 primary considerations:
 1. Chemical Product Strength
 2. Product Feed Rate
 3. Plant Flow
 4. Dosage
- The Davidson Pie diagram can be used to solve for feed rate (lbs or lbs/day), flow (MGD) or dosage (mg/L) by using the following formulas:
 1. Feed Rate, lbs/day = Flow (MGD) or Volume (MG) x Dosage (mg/L) x 8.34 (which is the density of water)
 2. Flow (MGD) = $\frac{\text{Feed Rate (lbs/day)}}{[\text{Dosage (mg/L)} \times 8.34]}$
 3. Dosage (mg/L) = $\frac{\text{Feed Rate (lbs/day)}}{[\text{Flow(MGD)} \times 8.34]}$
- In order to use any of these formulas, all flows or volumes must be converted to either million gallons per day (MGD) or million gallons (MG).

- If you are calculating a feed rate (lbs/day) for a solution that is not a 100% pure chemical (like caustic soda), remember to:
 1. Calculate the feed rate as if it's 100% pure,
 2. Then divide the feed rate of 100% pure chemical by the percent purity of the solution (as a decimal).
- The “active ingredient” weight provides the pounds of active ingredients that are found in each gallon of certain % solution. This “active ingredient” weight can then be used to determine the number of gallons you need to feed from the “lbs/day” feed rate.
- Pump calibration is conducted to determine the pump’s feed rate. The chemical feed pump must be calibrated to deliver the selected dosage.
- Setting the proper feed pump setting to deliver the selected dosage involves:
 - Step 1: Determining actual feed pump output for each stroke and speed setting.
 - Step 2 – Developing a feed pump calibration curve for each stroke setting.
 - Step 3 – Selecting the pump setting from all the % stroke calibration tables (and plotted calibration curves) that provides the calculated feed rate.
 - The optimal pump setting would take into account:
 - The dosage required.
 - The manufacturer’s recommendations for minimum and maximum settings.
 - The linearity of the “curves”. A more linear (straight) curve is better.
- The theoretical pump output can be calculated using the following equation:

Pump Output = Maximum Pump Output X %Speed X %Stroke

This formula should only be used as an estimate because the values are accurate only when the pump is brand new and under ideal conditions.



Exercise for Unit 4 – Chemical Feed Components and Pump Calibration

1. Liquid chemical feed components consist of:
 - a. Chemical Storage
 - b. Calibration cylinder
 - c. Metering Pump
 - d. Pulsation Damper
 - e. All of the above

2. Secondary spill containment areas should be provided and include leak detection equipment to provide an alarm in the event of a chemical spill or leak.

a) True b) False

3. The _____ is used to prevent the pump from losing prime.

4. A clogged suction assembly can be cleaned with a weak acid solution (i.e., vinegar or 1:1HCL).

a) True b) False

5. Volumetric/Gravimetric dry feeders are extremely accurate. (circle correct answer)

6. Chemical feed calculations involve 4 considerations:
 1. Dosage
 2. Plant Flow
 3. Chemical Product Strength
 4. _____

7. Why should the discharge point of the injector assembly should be located in the middle of the flow of the pipe?

_____.

8. A pump calibration curve plots feed rate delivery versus the _____.

APPENDIX: CORROSION CHEMICAL TABLE

Chemical Name	Chemical Formula	Common Use	Available Forms	Weight lb/ft ³ or lb/gal	Commercial Strength	Best Feeding Form	Active Chemical Strength lb/gal	Batch Strength lb/gal
Blended Phosphates	Varies with manufacturer	Corrosion Control	Powder, Liquid	Varies	Varies	Varies	varies	Per Manufacturer
Calcium Hydroxide (Hydrated Lime)	Ca(OH) ₂	pH Adjustment & Coagulation	Powder	20 – 50 lb/ft ³	82 – 95%	Dry to form slurry	0.93 (10% slurry)	0.93 (10% slurry)
Calcium Oxide (Quick Lime)	CaO	pH Adjustment & Coagulation	Lump, Pebble, Granular, Ground, Pellet	Granules 68 – 80 Powder 32 – 50 lb/ft ³	70 – 96% (below 85% can be poor quality)	¼ - ¾ inch pebble (Slaker) Feed as slurry	1.4 – 3.3 (Slaker) (2.1 avg)	0.93 (10% slurry)
Orthophosphates	Varies with manufacturer	Corrosion Control	Powder, Liquid	Varies	Varies	Varies	varies	Per Manufacturer
Polyphosphates	Varies with manufacturer	Corrosion Control	Powder, Liquid	Varies	Varies	Varies	varies	Per Manufacturer
Sodium Bicarbonate	NaHCO ₃	pH Adjustment & Coagulation	Granular, Powder	59 – 62 lb/ft ³	99%	Dry to form solution	0.3	0.3
Sodium Carbonate (Soda Ash)	Na ₂ CO ₃	pH Adjustment & Coagulation	Granular, Powder	50 – 70 lb/ft ³	98%	Dry to form solution	0.25	0.25
Sodium Hexa-Meta Phosphate	(NaPO ₃) ₆	Corrosion Control	“Glass”	65 – 100 lb/ft ³	67%	Dry to form solution	1.0	1.0
Sodium Hydroxide	NaOH	pH Adjustment & Coagulation	Flake, Lump, Powder	45 – 70 lb/ft ³	99%	Dry to form Solution		
Sodium Hydroxide (Caustic Soda)	NaOH	pH Adjustment & Coagulation	Liquid	12 – 75 lb/gal	12 – 50%	Liquid	6.38 for 50% solution	Neat

Safety Data Sheets (formerly MSDS)

A Safety Data Sheet, or SDS, is available from the chemical manufacturer/supplier for every chemical. For years, these sheets were commonly known as MSDS for Material Safety Data Sheet. However, the Occupational Safety and Health Administration (OSHA) Hazard Communication Standard of 2012 (HazCom 2012) mandates the use of a single format for safety data sheets featuring 16 sections. MSDS sheets can be used by manufacturers until June 1, 2015, but many manufacturers are complying before this date.

You should read and understand the SDS for each chemical used in the plant. You should also maintain a personal copy for all hazardous chemicals that are used.

An SDS contains detailed assessments of chemical characteristics, hazards and other information relative to health, safety and the environment. The SDS includes:

- **Section 1, Identification**
- **Section 2, Hazard(s) identification**
- **Section 3, Composition/information on ingredients**
- **Section 4, First-aid measures**
- **Section 5, Fire-fighting measures**
- **Section 6, Accidental release measures**
- **Section 7, Handling and storage**
- **Section 8, Exposure controls/personal protection**
- **Section 9, Physical and chemical properties**
- **Section 10, Stability and reactivity**
- **Section 11, Toxicological information**
- **Section 12, Ecological information**
- **Section 13, Disposal considerations**
- **Section 14, Transport information**
- **Section 15, Regulatory information**
- **Section 16, Other information**, includes the date of preparation or last revision.

Safety Data Sheet

1. IDENTIFICATION OF THE MATERIAL AND SUPPLIER

Product Name: CAUSTIC SODA - LIQUID (46%-50%)

Other name(s): Sodium hydroxide - liquid (46%-50%), Soda lye solution (46%-50%), Caustic soda solution (46%-50%), Sodium hydroxide solution (46%-50%), Liquid caustic soda (46%-50%), LCS 46%, Rezolv 46, Algane C46, Rezolv 50.

Recommended use of the chemical and restrictions on use: Chemical manufacture; neutralizing agent; pulp and paper, aluminum, detergent, and textile processing; vegetable oil refining; reclaiming rubber; etching and electroplating; food additive.

Supplier: ABC Chemical
ABN: 55555
Street Address: 3000 Roadway
 Roadway, PA

Telephone Number: 555-555-5555
Facsimile: 555-555-5555
Emergency Telephone: 1 800-555-5555

2. HAZARDS IDENTIFICATION

Classified as Dangerous Goods by the criteria of the Australian Dangerous Goods Code (ADG Code) for Transport by Road and Rail; DANGEROUS GOODS.

This material is hazardous according to Safe Work Australia; HAZARDOUS SUBSTANCE.

Classification of the substance or mixture:

Corrosive to Metals - Category 1 Skin Corrosion - Sub-category 1B Eye Damage - Category 1

SIGNAL WORD: POISON



CORROSIVE

8

Hazard Statement(s):

H290 May be corrosive to metals.

H314 Causes severe skin burns and eye damage.

Precautionary Statement(s): Prevention:

P234 Keep only in original container.

P260 Do not breathe dust/fume/gas/mist/vapors/spray. P264 Wash hands thoroughly after handling.

P280 Wear protective gloves/protective clothing/eye protection/face protection.

Safety Data Sheet

Response:

P301+P330+P331 IF SWALLOWED: Rinse mouth. Do NOT induce vomiting.
 P303+P361+P353 IF ON SKIN (or hair): Take off immediately all contaminated clothing. Rinse skin with water/shower. P363 Wash contaminated clothing before re-use.
 P304+P340 IF INHALED: Remove person to fresh air and keep comfortable for breathing. P310 Immediately call a POISON CENTER or doctor/physician.
 P321 Specific treatment (see First Aid Measures on Safety Data Sheet).
 P305+P351+P338 IF IN EYES: Rinse cautiously with water for several minutes. Remove contact lenses, if present and easy to do. Continue rinsing.
 P390 Absorb spillage to prevent material damage.

Storage:

P405 Store locked up.
 P406 Store in corrosive resistant container with a resistant inner liner.

Disposal:

P501 Dispose of contents/container in accordance with local/regional/national/international regulations.

Poisons Schedule (SUSMP): S6 Poison.

3. COMPOSITION/INFORMATION ON INGREDIENTS

Components	CAS Number	Proportion	Hazard Codes
Water	7732-18-5	50-54%	-
Sodium hydroxide	1310-73-2	46-50%	H290 H314 H318

4. FIRST AID MEASURES

For advice, contact a Poisons Information Centre or a doctor.

Inhalation:

Remove victim from area of exposure - avoid becoming a casualty. Remove contaminated clothing and loosen remaining clothing. Allow patient to assume most comfortable position and keep warm. Keep at rest until fully recovered. For all but the most minor symptoms arrange for patient to be seen by a doctor as soon as possible, either on site or at the nearest hospital.

Skin Contact:

If spilt on large areas of skin or hair, immediately drench with running water and remove clothing. Continue to wash skin and hair with plenty of water (and soap if material is insoluble) until advised to stop by the Poisons Information Centre or a doctor.

Eye Contact:

If in eyes, hold eyelids apart and flush the eye continuously with running water. Continue flushing until advised to stop by a Poisons Information Centre or a doctor, or for at least 15 minutes.

Ingestion:

Immediately rinse mouth with water. If swallowed, do NOT induce vomiting. Give a glass of water. Seek immediate medical assistance.

Safety Data Sheet

Indication of immediate medical attention and special treatment needed:

Treat symptomatically. Can cause corneal burns.

5. FIRE FIGHTING MEASURES**Suitable Extinguishing Media:**

Not combustible, however, if material is involved in a fire use: Fine water spray, normal foam, dry agent (carbon dioxide, dry chemical powder).

Hazchem or Emergency Action Code: 2R

Specific hazards arising from the substance or mixture:

Non-combustible material.

Special protective equipment and precautions for fire-fighters:

Not combustible, however following evaporation of aqueous component residual material can decompose if involved in a fire, emitting toxic fumes. Contact with metals may liberate hydrogen gas which is extremely flammable. Fire fighters to wear self-contained breathing apparatus and suitable protective clothing if risk of exposure to products of decomposition.

6. ACCIDENTAL RELEASE MEASURES**Emergency procedures/Environmental precautions:**

Clear area of all unprotected personnel. If contamination of sewers or waterways has occurred advise local emergency services.

Personal precautions/Protective equipment/Methods and materials for containment and cleaning up:

Slippery when spilled. Avoid accidents, clean up immediately. Wear protective equipment to prevent skin and eye contact and breathing in vapors. Work up wind or increase ventilation. Contain - prevent run off into drains and waterways. Use absorbent (soil, sand or other inert material). Collect and seal in properly labelled containers or drums for disposal. Caution - heat may be evolved on contact with water.

7. HANDLING AND STORAGE

This material is a Scheduled Poison S6 and must be stored, maintained and used in accordance with the relevant regulations.

Precautions for safe handling:

Avoid skin and eye contact and breathing in vapor, mists and aerosols.

Conditions for safe storage, including any incompatibilities:

Store in cool place and out of direct sunlight. Store away from incompatible materials described in Section 10. Store away from foodstuffs. Do not store in aluminum or galvanized containers nor use die-cast zinc or aluminum bungs; plastic bungs should be used. At temperatures greater than 40°C, tanks must be stress relieved. Keep containers closed when not in use - check regularly for leaks.

Safety Data Sheet

8. EXPOSURE CONTROLS/PERSONAL PROTECTION

Control Parameters: No value assigned for this specific material by Safe Work Australia. However, Workplace Exposure Standard(s) for constituent(s):

Sodium hydroxide: Peak Limitation = 2 mg/m³

As published by Safe Work Australia Workplace Exposure Standards for Airborne Contaminants.

Peak Limitation - a maximum or peak airborne concentration of a particular substance determined over the shortest analytically practicable period of time which does not exceed 15 minutes.

These Workplace Exposure Standards are guides to be used in the control of occupational health hazards. All atmospheric contamination should be kept to as low a level as is workable. These workplace exposure standards should not be used as fine dividing lines between safe and dangerous concentrations of chemicals. They are not a measure of relative toxicity.

Appropriate engineering controls:

Ensure ventilation is adequate and that air concentrations of components are controlled below quoted Workplace Exposure Standards. If inhalation risk exists: Use with local exhaust ventilation or while wearing suitable mist respirator. Keep containers closed when not in use.

Individual protection measures, such as Personal Protective Equipment (PPE):

The selection of PPE is dependent on a detailed risk assessment. The risk assessment should consider the work situation, the physical form of the chemical, the handling methods, and environmental factors.

Orica Personal Protection Guide No. 1, 1998: D - OVERALLS, CHEMICAL GOGGLES, FACE SHIELD, GLOVES (Long), APRON, RUBBER BOOTS.



Wear overalls, chemical goggles, face shield, elbow-length impervious gloves, splash apron or equivalent chemical impervious outer garment, and rubber boots. Always wash hands before smoking, eating, drinking or using the toilet. Wash contaminated clothing and other protective equipment before storage or re-use.

If risk of inhalation exists, wear suitable mist respirator meeting the requirements of AS/NZS 1715 and AS/NZS 1716.

9. PHYSICAL AND CHEMICAL PROPERTIES

Physical state: Liquid

Color: Colorless to Slightly Colored

Product Name: CAUSTIC SODA - LIQUID (46%-50%)

Issued: 03/12/2012
Version: 5

Safety Data Sheet

Solubility: Miscible with water.
Specific Gravity: 1.48-1.52 @20°C
Relative Vapor Density (air=1): Not available
Vapor Pressure (20 °C): 1.34 mm Hg (calculated)
Flash Point (°C): Not applicable
Flammability Limits (%): Not applicable **Autoignition Temperature (°C):** Not applicable **Boiling Point/Range (°C):** ca. 145 (literature) **pH:** 14 (literature)
Freezing Point/Range (°C): ca. 12 (calculated)

10. STABILITY AND REACTIVITY

Reactivity: Reacts violently with acids. Reacts exothermically on dilution with water.

Chemical stability: Stable under normal ambient and anticipated storage and handling conditions of temperature and pressure. Absorbs carbon dioxide from the air.

Possibility of hazardous reactions: Reacts with ammonium salts, evolving ammonia gas. Reacts readily with various reducing sugars (i.e. fructose, galactose, maltose, dry whey solids) to produce carbon monoxide. Take precautions including monitoring the tank atmosphere for carbon monoxide to ensure safety of personnel before vessel entry.

Conditions to avoid: Avoid exposure to moisture.

Incompatible materials: Incompatible with ammonium salts, aluminium, tin, and zinc.

Hazardous decomposition products: None known.

11. TOXICOLOGICAL INFORMATION

No adverse health effects expected if the product is handled in accordance with this Safety Data Sheet and the product label. Symptoms or effects that may arise if the product is mishandled and overexposure occurs are:

Ingestion: Swallowing can result in nausea, vomiting, diarrhea, abdominal pain and chemical burns to the gastrointestinal tract.

Eye contact: A severe eye irritant. Corrosive to eyes; contact can cause corneal burns. Contamination of eyes can result in permanent injury.

Skin contact: Contact with skin will result in severe irritation. Corrosive to skin - may cause skin burns.

Inhalation: Breathing in mists or aerosols may produce respiratory irritation.

Acute toxicity: No LD50 data available for the product. For the constituent Sodium hydroxide :

Safety Data Sheet

Skin corrosion/irritation: Severe irritant (rabbit).
Chronic effects: No information available for the product.

12. ECOLOGICAL INFORMATION

Ecotoxicity Avoid contaminating waterways.

13. DISPOSAL CONSIDERATIONS

Disposal methods:
Refer to Waste Management Authority. Dispose of contents/container in accordance with local/regional/national/international regulations.

14. TRANSPORT INFORMATION

Road and Rail Transport

Classified as Dangerous Goods by the criteria of the Australian Dangerous Goods Code (ADG Code) for Transport by Road and Rail; DANGEROUS GOODS.



CORROSIVE

8

UN No: 1824

Transport Hazard Class: 8 Corrosive

Packing Group: II

Proper Shipping Name or Technical Name: SODIUM HYDROXIDE SOLUTION 2R

Hazchem or Emergency Action Code:

Safety Data Sheet

Marine Transport

Classified as Dangerous Goods by the criteria of the International Maritime Dangerous Goods Code (IMDG Code) for transport by sea; DANGEROUS GOODS.

UN No: 1824

Transport Hazard Class: 8 Corrosive

Packing Group: II

Proper Shipping Name or

Technical Name:

SODIUM HYDROXIDE SOLUTION

IMDG EMS Fire: F-A

IMDG EMS Spill: S-B

Air Transport

Classified as Dangerous Goods by the criteria of the International Air Transport Association (IATA) Dangerous Goods Regulations for transport by air; DANGEROUS GOODS.

UN No: 1824

Transport Hazard Class: 8 Corrosive

Packing Group: II

Proper Shipping Name or

Technical Name:

SODIUM HYDROXIDE SOLUTION

15. REGULATORY INFORMATION

Classification:

This material is hazardous according to Safe Work Australia; HAZARDOUS SUBSTANCE.

Classification of the substance or mixture:

Corrosive to Metals - Category 1 Skin Corrosion - Sub-category 1B Eye Damage - Category 1

Hazard Statement(s):

H290 May be corrosive to metals.

H314 Causes severe skin burns and eye damage.

Poisons Schedule (SUSMP): S6 Poison.

All the constituents of this material are listed on the Australian Inventory of Chemical Substances (AICS).

16. OTHER INFORMATION

'Registry of Toxic Effects of Chemical Substances'. Ed. D. Sweet, US Dept. of Health & Human Services: Cincinnati, 2012.

This safety data sheet has been prepared by Orica Toxicology & SDS Services.

Reason(s) for Issue:

Addition/Change of synonymous name(s)

Product Name: CAUSTIC SODA - LIQUID (46%-50%)

Issued: 03/12/2012
Version: 5

APPENDIX: MSDS FOR 50% CAUSTIC SODA

This SDS summarizes to our best knowledge at the date of issue, the chemical health and safety hazards of the material and general guidance on how to safely handle the material in the workplace. Since Orica Limited cannot anticipate or control the conditions under which the product may be used, each user must, prior to usage, assess and control the risks arising from its use of the material.

If clarification or further information is needed, the user should contact their Orica representative or Orica Limited at the contact details on page 1.

Orica Limited's responsibility for the material as sold is subject to the terms and conditions of sale, a copy of which is available upon request.