

Drinking Water Operator Certification Training



General Overview Volume III

Revised February 2023

This course includes content developed by the Pennsylvania Department of Environmental Protection (Pa. DEP) in cooperation with the following contractors, subcontractors, or grantees:

The Pennsylvania State Association of Township Supervisors (PSATS)
Gannett Fleming, Inc.
Dering Consulting Group
Penn State Harrisburg Environmental Training Center

Topical Outline

Unit 1 – Overview of Disinfection

- I. Purposes of Disinfection
 - A. General
 - B. Regulatory Requirements

- II. Microbiological Contaminants
 - A. Bacteria
 - B. Viruses
 - C. Intestinal Parasites

- III. Factors Influencing Disinfection
 - A. Organisms
 - B. Temperature
 - C. pH
 - D. Disinfection Byproducts
 - E. Disinfection Demand
 - F. Process Control
 - G. Time

- IV. Disinfection Processes and Descriptions
 - A. Chemical Disinfection
 - B. Irradiation

- V. History of Disinfection Procedure

Unit 2 – Introduction to Maintenance

- I. Overview
 - A. Definition of Maintenance
 - B. The Role of Maintenance in the Overall Operation

Unit 3 –Typical Maintenance Procedures

- I. Centrifugal Pumps
 - A. Shaft Seal Adjustment
 - B. Lubrication
 - C. Condition Assessment

- II. Metering Pumps

Unit 4 – Distribution Networks

- I. Distribution Network Components
 - C. Introduction to Distribution Networks
 - D. Transmission Systems
 - E. Water Mains
 - F. Distribution Storage
 - G. Distribution Pumping
 - H. Valves
 - I. Meters
 - J. Fire Hydrants
 - K. Backflow Prevention

- II. Distribution Hydraulics
 - A. Pressure and Head

- III. Routine Maintenance and Repairs
 - A. Pipeline Maintenance and Repairs
 - B. Storage Tank Maintenance
 - C. Miscellaneous Distribution System Maintenance

Unit 5 – Other Hazard Sources at Treatment Plants

- I. Mechanical Hazards
 - A. Rotating Equipment
 - B. Crushing
 - C. Lockout/Tagout Program
 - D. Eye Protection
- II. Electrical Hazards
- III. Noise
 - A. Sources
 - B. Exposure Limits
 - C. Monitoring
 - D. Hearing Conservation Program
 - E. Noise Reduction and Hearing Protection
- IV. Slip, Trip and Fall Hazards
 - A. Walking/Working Surfaces
 - B. Stairs, Ladders and Scaffolds
 - C. Working at Elevations
 - D. Working Above 4 Feet or Adjacent to Water or Hazardous Equipment
- V. Excavations
 - A. Considerations
 - B. Inspections
 - C. Soil Classifications
 - D. Protective Systems
- VI. Confined Space
 - A. Characteristics of a Permit-Required Confined Space
 - B. Confined Entry Space Program

- VII. Fire
 - A. Classes of Fire
 - B. Fire Response Plan
 - C. Storage and Handling of Flammable Material/Other Chemical Storage Tips
 - D. Supplemental Reference Information
- VIII. Lifting Hazards
 - A. Manual Lifting Limits
 - B. Proper Lifting Procedure
 - C. NIOSH Lifting Equation
- IX. Traffic Hazards
- X. APPENDIX: Chemicals Used in Treatment

Unit 1 – Overview of Disinfection

Learning Objectives

- Explain the general purpose and regulatory requirements of the disinfection process.
- List bacteria, viruses and intestinal parasites that contaminate drinking water.
- List factors that influence disinfection and explain how they influence it.
- List five types of chemical disinfectants and explain the advantages and disadvantages of each.
- Explain how irradiation is used as a disinfection process.

General

Protect Public Health



Disinfection is the process designed to remove, kill or inactivate most microorganisms, including pathogenic bacteria, in a raw water supply.



Residual Disinfection is the process of maintaining a disinfectant level in the treated or finished water supply throughout a system to assure that re-growth of pathogenic microorganisms will not occur.

Regulatory Requirements

Groundwater

- ⦿ A sanitary survey of all potential well sites is required to assure that the aquifer is protected against potential sources of contamination. This should include surface sources and subsurface sources, evaluation of the local geology, current land use and proximity to flood plains.
 - A party desiring to obtain water from a well to be drilled is required to conduct a sanitary survey. The survey is performed thru desk top research, commonly using the internet, to define contaminated areas, locations of underground storage tanks and other potential sources of contamination. Subsequent field reviews and interviews are performed to further observe and identify potential pollutants of the source or well. Searches such as these are best performed by personnel trained in conducting these surveys.

DISINFECTION PURPOSE AND REGULATORY REQUIREMENTS

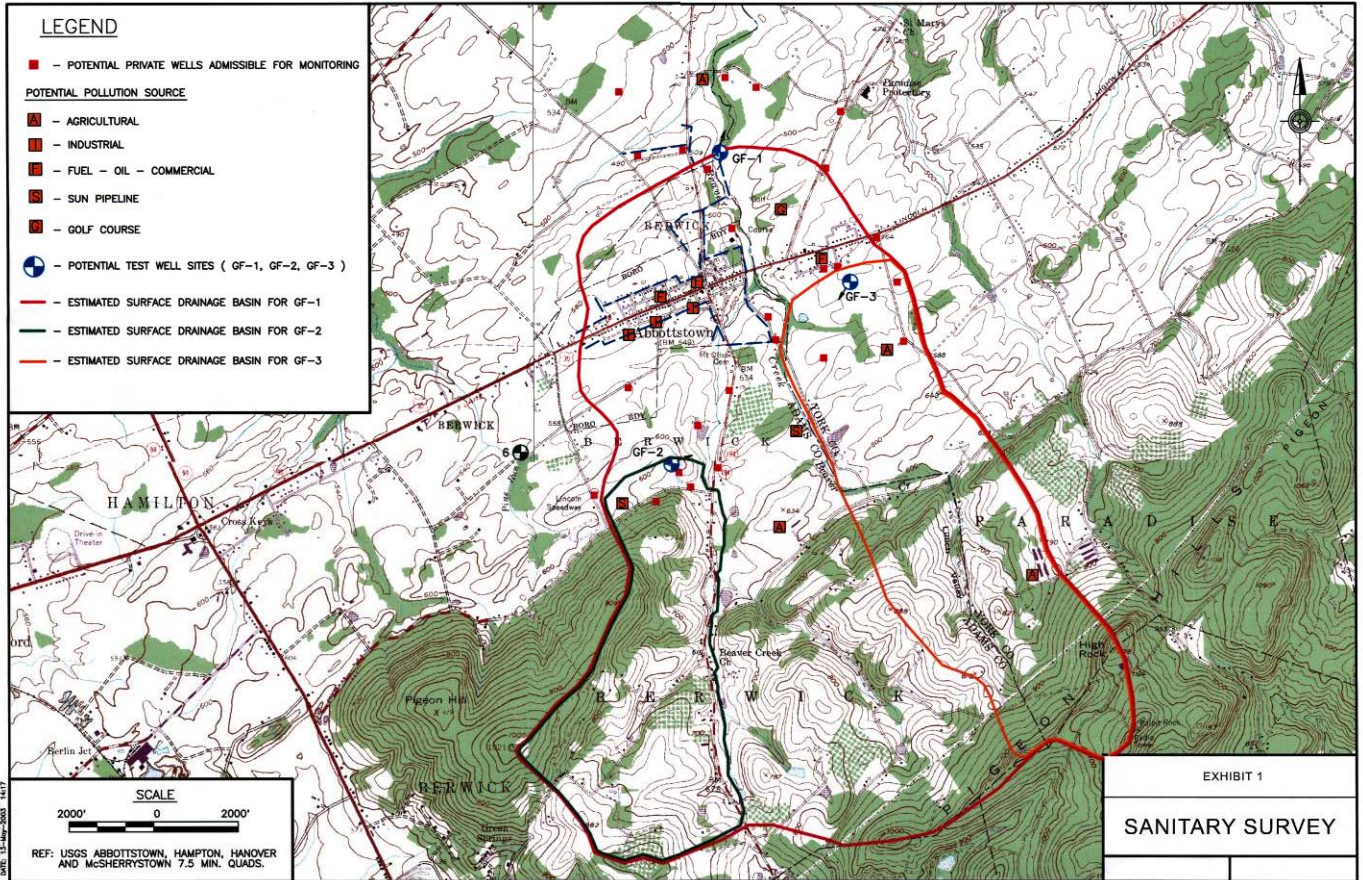

Figure 1.1 A Typical Presentation for a Sanitary Survey¹

A wellhead protection program should be implemented to assure that adverse development does not take place in the proximity of the well, which can lead to future contamination.

This is to be accomplished via ownership of surrounding property, or easements obtained from surrounding property owners.

Figure 1.2 shows a well with the property delineated that falls under the wellhead protection plan.

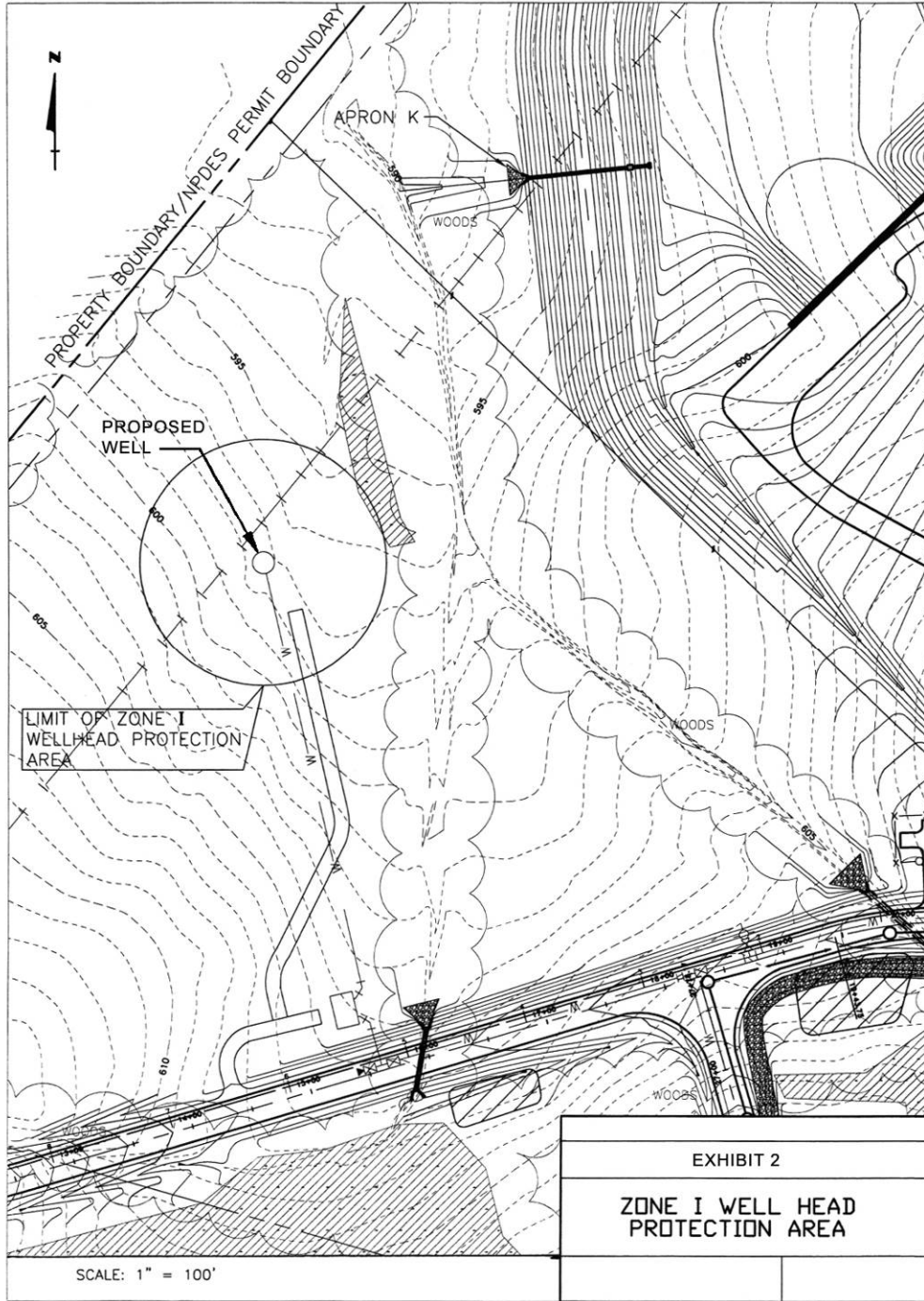

Figure 1.2 Wellhead Protection Area²

DISINFECTION PURPOSE AND REGULATORY REQUIREMENTS

- ⦿ Chemical treatment for well supplies as a minimum requires provision for disinfection to provide 4-log treatment of viruses (99.99% removal and/or inactivation).
- ⦿ For wells that are considered not to be under the influence of surface waters or requiring other forms of treatment, disinfection using chlorine or one of its compounds, followed by 20 minutes of detention time, is required.
- ⦿ Detention time is achieved by using a system that minimizes short-circuiting. For example, a baffled tank forces the water to flow through a circuitous route. The following figure shows a section through a tank of this type.
 - Short circuiting occurs when the flow path of water thru a vessel takes a route that is shorter and takes less time than desired. To avoid short circuiting, baffles are introduced into the flow path to force the flow to take a longer route through a vessel. This will assure that the time of flow through the vessel is lengthened and in contact with the disinfectant longer to maximize treatment.

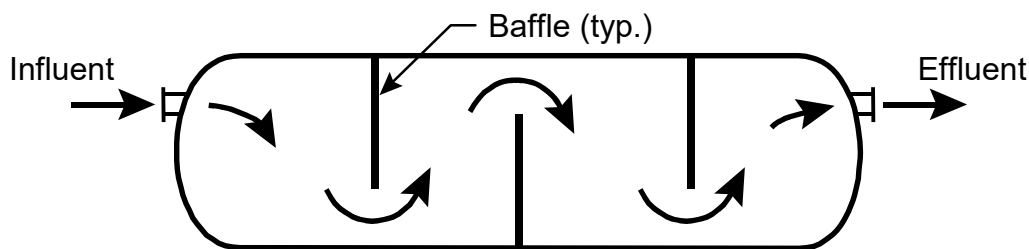

Figure 1.3 A Baffled Tank

Surface Water

Various forms of treatment may be required to clarify and disinfect surface waters.

- ⦿ Physical treatment of a raw water surface supply can remove pathogenic organisms. Some of these forms of treatment include filtration, ultraviolet rays (UV), heat and ultrasonic waves.
- ⦿ Chemical treatment includes coagulation followed by sedimentation, and treatment with oxidants such as chlorine and some of its compounds. Other chemicals such as iodine, bromine, sodium hydroxide and lime, as well as ozone are effective to varying degrees, but each has its drawbacks and is not commonly used as the primary disinfectant leaving a water treatment facility.

Various forms of microbiological contaminants may be found in raw water supplies. These include bacteria, viruses and intestinal parasites.

Bacteria

Common bacterial contaminants include the following:

- ⦿ *Salmonella*, which causes Salmonellosis.
- ⦿ *Shigella*, which causes Bacillary Dysentery.
- ⦿ *Bacillus typhosus*, which causes Typhoid.
- ⦿ *Salmonella paratyphi*, which causes Paratyphoid.
- ⦿ *Vibrio cholerae*, which causes Cholera.
- ⦿ *Escherichia coliform*

Viruses

Enteroviruses



Enteroviruses are a large family of viruses responsible for many infections in children such as viral meningitis, encephalitis and myelitis, among other illnesses. These viruses live in the intestinal tract, but can cause a wide variety of illnesses. Though more common in children, adults are also susceptible to these illnesses.

- ⦿ There are more than 70 different strains, which include the group A and group B coxsackieviruses, the echoviruses, the polioviruses, hepatitis A virus and several strains that just go by the name enterovirus.

- ⦿ These viruses can live for days at room temperature. Refrigerating and freezing do not inactivate them. They are, however, easy to kill with heat and with disinfectants.

Adenoviruses



Adenoviruses are very common viruses that can cause infections in children, such as tonsillitis, conjunctivitis, the common cold and other illnesses. Again, though more common in children, adults are also susceptible to these illnesses. There are over fifty subtypes of adenovirus.

- ⦿ Adenoviruses most commonly cause upper respiratory tract infections, including the common cold, sore throats, tonsillitis, ear infections and conjunctivitis.
- ⦿ Another common adenoviral infection is pharyngoconjunctival fever (sore throat, red eyes and a fever).
- ⦿ Less commonly, adenoviruses cause croup, pertussis syndrome or bronchitis.
- ⦿ Adenoviruses are a common cause of gastroenteritis. They can also cause urinary tract infections (UTI), including hemorrhagic cystitis, a UTI with blood in the urine.
- ⦿ In rare cases, adenoviruses cause pneumonia, meningitis or encephalitis.

Reoviruses



Reoviruses are responsible for many common human diseases such as colds, flu, diarrhea, chicken pox, measles and mumps.

- ⦿ Some viral diseases, such as rabies, hemorrhagic fevers, encephalitis, polio, yellow fever and acquired immunodeficiency syndrome (AIDS), can result in death.
- ⦿ German measles and cytomegalovirus can cause serious abnormalities or death in unborn infants.

Intestinal Parasites

Common intestinal parasites include the following:

- ⊙ *Entamoeba histolytica* (Amoebic Dysentery).
- ⊙ *Giardia lamblia* (Giardiasis).
- ⊙ *Ascaris lumbricoides* (Giant Roundworm).
- ⊙ *Cryptosporidium* (Cryptosporidiosis).

FACTORS INFLUENCING DISINFECTION

Several factors will influence the disinfection of water supplies. These include the type and number of organism, the water chemistry, the disinfection byproducts, the disinfection demand, process control and time.

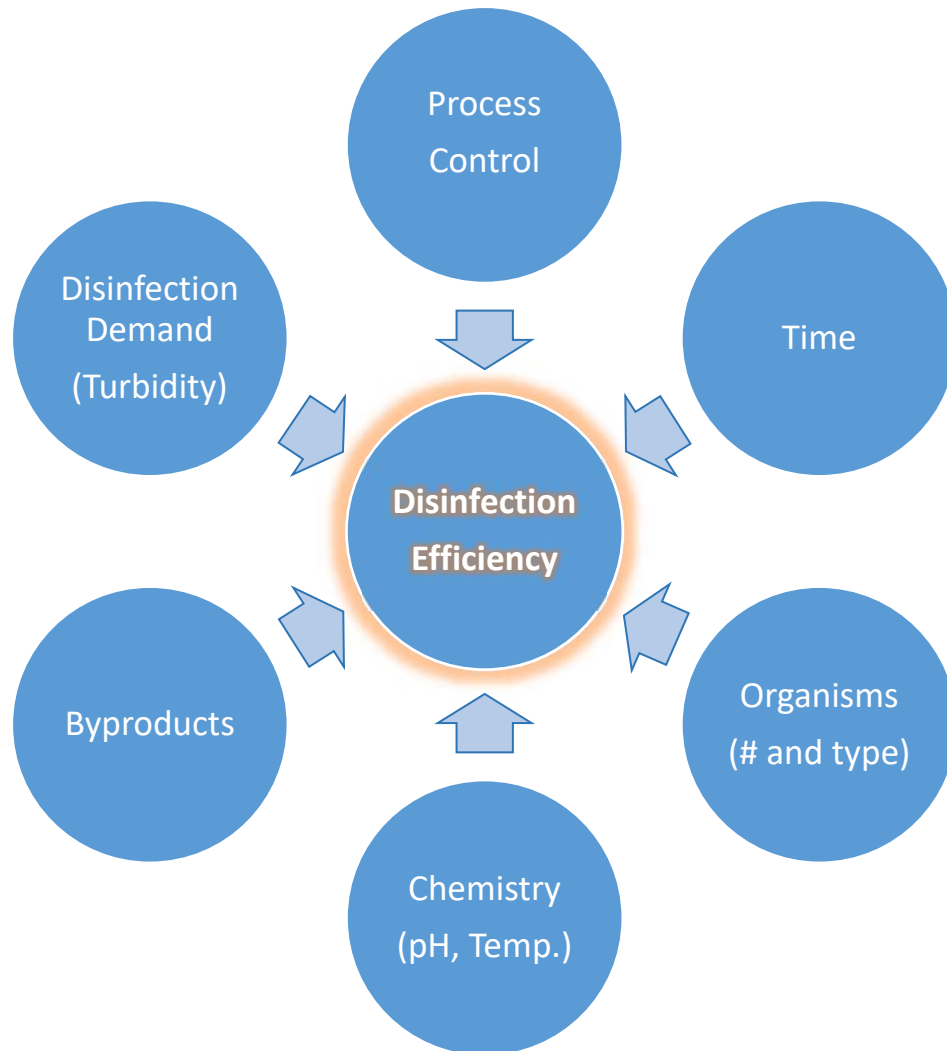

Organisms

The numbers and types of organisms could determine the type of disinfectant needed and the amount or dosage of that product.

In general, actual testing for these organisms is beyond the capability of the average lab. Testing is also time consuming and costly.

So, we use an indicator organism to determine the bacterial quality of the water.

Coliform bacteria make good indicator organisms because:

- They are always present when pathogens are present.
- The testing method for detection is easy and reliable.
- When they are absent, we can assume that pathogens are also absent.

Temperature

Disinfection of water with free chlorine will be more efficient at temperatures greater than 60°F than at temperatures less than 60°F.

- ⊙ Due to dissipation of chlorine into the atmosphere at warmer temperatures, it is important to monitor its residual throughout the disinfection process.

pH

Disinfection of water with free chlorine will be more efficient at values lower than 7.0 than at values greater than 7.0.

Disinfection Byproducts

Some people believe if a little is good, even more must be better. When it comes to chlorination, over-feeding may cause the formation of additional, harmful, byproducts.

- ⊙ Some of these reactions between organic compounds and chlorine will form regulated disinfection byproducts including trihalomethanes (THMs) and haloacetic acids (HAA). It is desirable to remove as much of these organic materials from the water as possible before disinfection with chlorine since the byproducts are carcinogenic.
- ⊙ All water systems that apply chlorine as a disinfectant must analyze for THMs. The number of samples analyzed and frequency is a function of system size and water source.

Disinfection Demand

Demand is defined as anything in the source water that will react with the disinfectant and make it unavailable for disinfection. This includes turbidity, inorganics and organic material.

Process Control

Process control refers to controlling the key parameters (chemical feed rates and application points, mixing time, detention time, etc.) to ensure proper water quality.

- Chemical feed of a disinfectant must be continuous and adequate.
- If the dosage of the disinfectant is not sufficient to kill the pathogenic organisms, breakthrough or re-growth may occur in the distribution system.

Time

Time is an important factor. Specifically, contact time is important. **Contact time is the amount of time in minutes deemed necessary for the applied chlorine to perform its disinfection function before the water is delivered to the first customer.**

Chemical Disinfection

Gas Chlorine

Gas chlorine is the pure elemental form of the chemical chlorine when delivered to a water treatment plant site. Although it is in liquid form in the pressurized vessel, it is converted to the gas form by evaporation in the delivery container or through evaporators in the facility.

Advantages

- ⊙ Gas chlorine is an effective disinfectant.
- ⊙ It lowers the pH of water, making it more effective as a disinfectant.
- ⊙ Gas chlorine is economical, stable, easy to use, and easy to apply.
- ⊙ It is easy to monitor to determine whether there is a residual disinfectant in the distribution system.

Disadvantages

- ⊙ Gas chlorine is an aggressive chemical that can corrode many materials it comes into contact with.
- ⊙ It can react with organics in either the raw water or finished water to form trihalomethanes and haloacetic acids, which are known carcinogens.
- ⊙ It requires special training to assure safe handling of the chemical and related equipment.
- ⊙ If a facility stores over 2,500 pounds of gas chlorine, a risk management plan must be prepared.

Hypochlorite

Hypochlorite generally is a compound of chlorine and either sodium or calcium.

Advantages

- ⊙ Hypochlorite is an effective disinfectant.
- ⊙ It is safer to handle than gas chlorine.
- ⊙ Hypochlorite is easy to use and apply and does not require special training for handling.
- ⊙ It is easy to monitor to determine whether there is a residual disinfectant in the distribution system.

Disadvantages

- ⊙ Hypochlorite solution is prone to degrade over time as chlorine vaporizes from solution, reducing its chlorine content, making it less effective and requiring a higher feed rate of the weaker product.
- ⊙ It may increase the pH of water and is less effective than gas chlorine.
- ⊙ It is an aggressive chemical that can corrode many materials it contacts.
- ⊙ Hypochlorite can react with organics in either the raw water or finished water to form trihalomethane and haloacetic acids, which are known carcinogenics.
- ⊙ It can "off gas" in the feed system, resulting in operational problems.
- ⊙ Hypochlorite can form chlorate, which may have adverse health impacts.

Chlorine Dioxide

Chlorine dioxide is a powerful disinfectant. It is relatively unstable and must be generated on site via the reaction of chlorine with sodium chlorite. Quantities of the chemical can be stored, but only for short durations. The chemical does not react with organic compounds and therefore is a good substitute for gas chlorine when a preoxidant is required and there is a high potential to form trihalomethanes.

Advantages

- Chlorine dioxide is an effective disinfectant that has pathogen removal values comparable to that of gas chlorine but at lower doses.

- It is still effective at higher pH values.
- Chlorine dioxide will not react with organics in either the raw water or finished water to form trihalomethanes or haloacetic acids.

Disadvantages

- Chlorine dioxide is an unstable chemical requiring on site generation.
- It requires the reaction of gas chlorine and sodium chlorite.
- In addition to the disadvantages associated with gas chlorine, sodium chlorite is a very aggressive chemical with strong bleaching capabilities and can spontaneously ignite when in the dry form and if it comes in contact with organic materials.
- The production of chlorine dioxide can generate chlorate and chlorite which may have adverse health impacts. It is therefore not used as the final disinfectant leaving a water treatment plant.

Chloramines

Although quite stable, chloramines are substantially less powerful as a disinfectant than the other forms of chlorine. They are therefore not used as the primary disinfectant in treatment plants, but rather as maintenance treatment following primary disinfection.

Advantages

- Although chloramines are a relatively weak disinfectant, they will maintain chlorine residual in the distribution system longer than free chlorine which is more prone to react with materials in the piping system.
- They will reduce the potential for trihalomethane and haloacetic formation in the distribution system.

Disadvantages

- Chloramines are not as effective as free chlorine at killing or inactivating pathogens.
- They must be monitored to assure that the **ammonia to chlorine feed ratio is properly maintained** at the feed point to ensure the generation of only the monochloramine variety of chloramines. Inadequate feed rates can generate the **dichloramine or trichloramine variety, which can create taste and odor** in the finished water.

Ozone

Ozone gas is an extremely powerful oxidant. It is very unstable and used immediately after manufacture. Although very effective as a disinfectant, its instability precludes its use as the final disinfectant entering the distribution system.

Advantages

- Ozone is the most effective disinfectant available of those commonly used in water treatment.
- It is more effective in treating for *Cryptosporidium* than other chemical disinfectants.
- Ozone will not generate trihalomethanes or haloacetic acids.

Disadvantages

- An ozone system is expensive to install and operate.
- Operating staff must become familiar with a relatively complex chemical feed system.
- Ozone is highly toxic and highly corrosive.
- It will not carry ozone residual into the distribution system, which means a second chlorine-based feed system is needed.

Irradiation

Ultra-violet Light

Ultra-violet is a band of non-visible light located between the purple end of the visible band, and x-rays. The waves are shorter than that of the visible spectrum, of higher frequency than the visible spectrum and higher energy than the visible spectrum. Light specifically in the wave lengths at and around 254 nanometers has been found to be readily absorbed by the cells of microorganisms causing damage to the genetic material. This damage, though not killing the microorganism, prevents it from reproducing itself.

Eventually the cell dies without replicating itself.

Advantages

- The use of ultra-violet light is an effective disinfectant process that can reliably inactivate *Cryptosporidium* oocysts.
- It is more effective than ozone in treating for *Cryptosporidium*.
- It is easier and less costly to operate than an ozone system.
- It will not form trihalomethanes or haloacetic acids.

Disadvantages

- This type of system is expensive to install and operate.
- The system requires routine maintenance to assure efficient operation.
- It requires the use of a chlorine-based chemical system to assure that a disinfectant chemical residual is carried into the distribution system.
- Standards have not been developed for the use of ultra-violet light as a disinfectant for water treatment.

Chlorination

United States – Historical Practices

- ⦿ Hypochlorination was first practiced in 1908 with the installation of a facility in Jersey City, New Jersey. This was followed by installations in Elmira, Poughkeepsie and Albany, New York.³
- ⦿ Gas chlorine was first used in Niagara Falls, New York in 1912.⁴

**Unit 1 Exercise**

- 1) Coliform bacteria make good indicator organisms because:
 - a) They are always present when pathogens are present.
 - b) The testing method for detection is easy and reliable.
 - c) Both (a) and (b)
 - d) When they are absent, we can't assume that pathogens are also absent.

- 2) Baffling in tanks provides:
 - a) A way to reduce short-circuiting
 - b) Decreased detention time
 - c) Increased detention time
 - d) Both (a) and (c)

For questions 3 and 4, underline the correct answer within the parentheses.

- 3) Disinfection of water with free chlorine will be **more efficient** at temperatures (lower/higher) than 60°F.
- 4) Disinfection of water with free chlorine will be **more efficient** at values (lower/higher) than 7.0.

- 5) List one advantage of using sodium or calcium hypochlorite versus gas chlorination.



Unit 1 Key Points

- Disinfection protects public health by rendering harmless or removing pathogenic microorganisms.
- Because of the importance to public health, the disinfection process has numerous regulatory requirements.
- Coliform is used as an indicator organism.
- The effectiveness of the disinfection process is influenced by many factors.
- Different disinfecting agents are available and their use depends on factors at each treatment system.

References

¹ Borough of Abbottstown, Adams County, Pennsylvania.

² Adams County Facilities Center, Straban Township, Adams County, Pennsylvania.

³ *Manual of Instruction for Water Treatment Plant Operators*, prepared by New York State Department of Health, Office of Environmental Health Manpower, Division of Pure Water, Office of Public Health Education, p. 153.

⁴ Connell, p. 4.

Unit 2 – Introduction to Maintenance

Learning Objectives

- Define maintenance
- Discuss the roles of maintenance
- Discuss safety practices of maintenance

OVERVIEW AND GOALS OF MAINTENANCE PROGRAM

Definition of Maintenance



Maintenance is a support function providing a cohesive process that assists operations and other departments in fulfilling the mission of the facility. This is achieved by ensuring that all equipment and systems are operated at an expected level of reliability within a specified budget and within the life cycle of the equipment.

The Role of Maintenance in the Overall Operation

As soon as a facility is built, its buildings and systems start a predictable decline in condition and efficacy. Some elements—such as a roof or building envelope—may have a life cycle of 25 to 30 years before major work is required. Other items—such as pumps and compressors—will need regular service almost immediately after start-up.

The role of maintenance is to identify and remedy potential problems before they impact plant operation. This requires establishment of a set of operating parameters. The design specifications for the equipment help to identify the maintenance parameters. By using a proactive approach (maintaining equipment so that it does not break down as often), we can ensure a level of service that ensures maximum operating efficiency.

As we mentioned in the previous section, a proactive approach to maintenance can prolong the usefulness of a facility.

Safety and Environmental Protection

Water treatment plants have a direct impact on public health. Plant operators constantly monitor process parameters to ensure the quality of the water.

It is the responsibility of the maintenance group to ensure that sensors, meters, and recorders function so that they can provide accurate data to the operators. This information is used to adjust plant processes to ensure the public receives a quality product.

It is equally important that valves and metering equipment function properly in response to plant operator requests.

Important: All required safety procedures must be followed at a water system. For example, drinking water system must have specially designed areas for chemical storage which allows containment in case of fire and explosion. Many accidents occur at treatment plants each year that could be avoided by following simple safety procedures such as the one listed above.

OVERVIEW AND GOALS OF MAINTENANCE PROGRAM

Good practice also extends to the actual service and maintenance of the equipment. Injuries to plant personnel result when people work without thinking through the tasks or they accept risks that are not necessary. Common ways to minimize hazards include:

- Using lockout-tagout procedures when isolating valves and equipment. Remember, the person performing the maintenance is responsible for initiating lock out/tag out protocol.
- Always replacing guards over moving parts after service.
- Before disconnecting power leads, mark the configuration. **Note: by hooking the leads in the reverse, you can change the direction of how a pump will run (e.g., a counter clockwise pump will run clockwise).**
- Following confined space procedures.
- Performing good housekeeping procedures.



Figure 2.1 Safety Hazard

Poorly maintained equipment can lead to:

- Poor water quality that is dangerous to public health.
- Hazardous discharges of chemicals to the environment.
- Safety hazards to plant personnel.

Unit 3 – Typical Pump Maintenance Procedures

Learning Objectives

- Discuss pump performance issues
- Discuss shaft adjustment
- Discuss mechanical seals
- Discuss lubrication of equipment

A review of typical Preventive Maintenance (PM) tasks contained in this unit will provide a guide to understanding what is expected in generating PM procedures. However, this unit will not give specific details on performing site-specific tasks. Only research into information about a site's unique equipment and how it functions within the content of the plant will allow specific tasks to be created. Depending on the facility, not all tasks discussed in this unit will be performed by in-house staff.

Pump Performance Issues

Before we review maintenance procedures, it is important to point out some pump performance issues.

To increase the life of a pump:

- It should be allowed to run for the longest period of time possible before being shut off. This helps to reduce the amount of starting torque on the thrust bearings and the pump. Starting also causes high power usage when compared to running the pump more consistently.
- Pump manufacturers always give a maximum amount of times a pump should be started per hour. This recommendation should be recorded in the O&M Manual and followed by the system.

Maintenance on a pump is important to keep the pump running at its optimum performance level. Worn impellers and bearings are just two issues that can cause poor performance.

It is important to note that when you see your pump performance affected, it is not always a problem with the pump itself.

- For example, if the pump is running but not discharging, troubleshooting could indicate that the pump has lost its prime, has a worn impeller or the valve on the discharge side is closed.
- These issues look like a pump problem, but they do not represent a pump maintenance problem.

Shaft Seal Adjustment

Shaft seals will be standard packing or mechanical.

Standard Packing Seals

Shaft seals are rings of gasket material that wrap around the shaft of the pump.

Shaft seals are contained within a "Stuffing box." This is a cylindrical box that surrounds the pump shaft designed to hold the packing rings. The box has packing nuts that can be tightened to maintain seals as the shaft seals wear.

- Proper packing adjustment consists of small, incremental taking up of the packing nuts to maintain proper sealing.
- When gland nuts are fully taken up, another ring of packing should be added.
- Periodically, the packing requires replacement.
- All rings need to be replaced, including the rings past the lantern ring (if utilized).
- Over-tightening leads to shaft/sleeve wear.
- Under-tightening leads to excess water leakage, which can cause corrosion of the gland bolts and allow water to infiltrate the bearings.

Note the leaking gland on a small circulating pump in Figure 3.1.



Figure 3.1 Leaking Gland

Mechanical Seals

In some situations, the packing material is not adequate for sealing the pump shaft. A mechanical seal can be used instead. A mechanical seal consists of:

1. A rotating element attach to the shaft
 2. A stationary element attached to the pump casing.
- Always follow the manufacturer's recommendations carefully.
 - Once installed, periodically check for leaks.
 - Rapid failure is a concern; replace leaking seals immediately.
 - Check flushing lines (if equipped) to make sure they remain clear.

Lubrication

Lubrication protects equipment. To achieve the highest level of protection, we must ensure an adequate supply of lubricant to the surfaces and maintain the lubricant quality.

Ensure an Adequate Supply of Lubricant to the Surfaces

Smaller equipment may be equipped with sealed bearings, so you won't need to lubricate these pieces. However, when bearings require grease, regular attention and periodic applications of grease are necessary.

Relief Plugs

- When equipped with a relief plug, always remove it before applying grease.
- Removing the plug while greasing will also work the old grease out of the bearing.
- Apply the grease and run the unit to allow excess grease to work out of the relief plug.

Bearings

- Oil lubricated bearings typically utilize a sight glass or bowl. This indicates the fluid level and provides additional reservoir capacity. Note: the manufacturer might recommend that you check your electrical amperage before greasing bearings and then again after greasing. If an increase in electrical amperage is detected, the drag on the bearings has increased due to over greasing the bearings.
- If the bearings are water cooled, check the inlet and outlet temperatures to ensure that flow is adequate.

Chain Drives

- Enclosed chain drives will have the lower casing act as an oil sump and may have an oil spray pump.
- It is important in oil lubricated systems to use a product with the correct viscosity for the application.

Maintain the Lubricant Quality

- Impurities reduce the effectiveness of the lubricant.
- Oil bearings can be contaminated with water from leaky glands. Water displaces the oil and allows metal-to-metal contact.
 - Periodically check the bearing sump for the presence of water.
- Always wipe the grease fitting or oil fill point prior to adding lubricant to avoid carrying foreign matter into the bearing.

Condition Assessment

The most common means of assessing the condition of a pump is for the operator or maintainer to look, touch, listen, and check the instrumentation (i.e., flow and amperage). While these are all good first steps in the maintenance procedure, they tend to be imprecise. Developing problems may be missed by the use of these tools. Various testing measures that are more precise can be applied; one such method is vibration analysis.

Vibration analysis is applied to pumps and other rotating equipment as a common means of determining condition. As with other predictive measures, a history should be built to pinpoint developing trends.

Such things as worn bearings, worn housings, loose bolts, and misalignment can cause excessive vibration in a pump. Misalignment can occur within a pump or between a motor and a pump which causes excessive vibration.

Figure 3.2 shows a close-up of an electric motor with an identification tag indicating the point to be tested.



Figure 3.2 Vibration Analysis Point

Metering Pumps (Chemical Feed Pumps)

A variety of low volume pumps are utilized for dispensing chemicals. All pumps should receive some PM; however, a decision must be made pertaining to which pumps are worth repairing. For example, a .25 GPH solenoid-actuated diaphragm pump costs about \$290.00, and it may not warrant extensive and costly repairs.

Having spare or back-up metering pump(s) on hand will ensure that necessary chemical addition continues without interruption.

General considerations for metering pump repairs include the following guidelines.

- Be sure that replacement parts are appropriate for the system.
 - Know what materials for packing, fasteners, and pipe and valve fittings are compatible with the chemicals being handled. Have key replacement parts on hand.
 - For diaphragm pumps, diaphragms are to be replaced per manufacturer recommendations.
 - For peristaltic pumps, flexible tube replacement per manufacturer recommendations.
- All leaks must be identified and repaired promptly.
- Make repairs to piping with the fewest joints and simplest runs.
- Keep gearboxes at proper oil levels.
- Ensure that mountings are tight in order to prevent vibration that can be transmitted to the piping.
- Keep intake strainers clean.
- Ensure that check valves operate.
 - Foot valves prevent the loss of prime.
 - Discharge valves on common header lines prevent back pressure on off-line pumps.
- Observe strokes per minute, and compare the results to the pump curve. Calibration cylinders should be installed properly on the suction side of the metering pump to accurately calibrate the metering pump flow rates to ensure the proper amount of chemical is being dispensed.
- Be proactive in service. A joint leakage could cause an air gap on the suction side of a positive discharge pump which is harmful to the pump.



Unit 2 & 3 Exercise

1. List good plant safety maintenance practices.

- a) _____
- b) _____
- c) _____
- d) _____
- e) _____

2. What can cause excessive vibration in a pump?

3. List 3 general considerations for metering pump repairs.

- a) _____
- b) _____
- c) _____

For question 4, underline the correct answer within the parentheses.

4. An air gap on the (discharge/suction) side of a positive discharge pump could be harmful.



Unit 2 & 3 Key Points

- Maintenance is a support function providing a cohesive process that assists Operations and other departments in fulfilling the mission of the facility.
- All required safety procedures must be followed at a water system. For example, drinking water system must have specially designed areas for chemical storage which allows containment in case of fire and explosion.
- When you see your pump performance affected, it is not always a problem with the pump itself. For example, if the pump is running but not discharging, troubleshooting could indicate that the pump has lost its prime, has a worn impeller or the valve on the discharge side is closed.
- A variety of low volume pumps are utilized for dispensing chemicals.
- The most common means of assessing the condition of a pump is for the operator or maintainer to look, touch, listen, and check the instrumentation (i.e., flow and amperage).
- Be proactive in service. A joint leakage could cause an air gap on the suction side of a positive discharge pump which is harmful to the pump.

Unit 4 – Distribution Networks

Learning Objectives

- Identify the key components of a distribution network and describe the primary purpose or function of each component.
- Define the relationship among pressure and head.
- Outline the relationship between distribution system customers' demands and their effects on distribution system performance.
- List five programs involved in routine maintenance of distribution networks.
- List three key components of a pipeline maintenance program.

Introduction to Distribution Networks

Purposes of Distribution Networks

- The primary purpose of a distribution network is to deliver adequate volumes of safe drinking water to system customers at adequate pressures.
- Another important purpose of a distribution network is to provide adequate fire flows to areas of the system.

Components of Distribution Network

Distribution systems are composed of various types of valves, fire hydrants, water meters and pumps that, together, protect public health and provide water to the public. Distribution systems must maintain safe drinking water quality, adequate pressure, high clarity and taste that are acceptable to the public.

- Pipes
- Storage Facilities
- Pumps
- Valves
- Meters
- Hydrants

Pipes

Purpose of Transmission Systems

Transmission systems are used to convey water from a system's source of supply to the distribution network.

Typical Characteristics of Transmission Systems

- Large diameter pipelines
- May be miles in length
- Typically, no service connections directly from a transmission system

Pipe Features

- Size
 - Distribution network pipes are normally sized to accommodate normal and peak system flows and fire flows without adversely impacting water quality or resulting in an excessive pressure drop.

- Material
 - Distribution network pipes are constructed of material that is durable and corrosion resistant.
 - Materials currently used for distribution network pipes include ductile iron, steel, concrete, and plastic.
 - Materials often used for older pipes in a distribution network include cast iron, asbestos cement, galvanized iron, and wood.

- Pressure Rating
 - The pressure rating of a pipe is a measure of the maximum normal pressure that a pipe is able to withstand.
 - The pressure rating of a pipe will vary based on pipe material and pipe class.

Service Connections

- Service lines are used to convey water from the distribution network to individual system customers. Typical materials used for service lines include plastic, copper, steel, iron and lead. Lead service lines are being neutralized by corrosion control practices or are being removed from service.

- A corporation stop or shut-off valve is typically located at the connection of the service line and distribution pipe.

- An additional shut-off valve, the curb stop, is typically located along the service line, near the customer property line.

- The customer meter used for billing purposes is located on the downstream side of the curb stop.

- Backflow prevention devices are installed at customer meters or between the meter and the customer's line to prevent contamination of the distribution network from potential backflow.

Storage Facilities

The main purpose of a water storage facility is to provide a sufficient amount of water to equalize the daily demands on the water supply system. The storage facility should be able to provide water for both average and peak demands. Storage facilities:

- Help minimize fluctuations in system pressure;
- Provide reserve volumes of water to help meet fire flow needs;
- Provide an emergency source of supply for the system, and;
- Help offset fluctuations in system demands

Types of Water Storage Facilities:

- Elevated Tanks are used primarily to maintain system pressure.
- Stand Pipes are storage tanks that are set on the ground.
- Reservoir or ground level storage tanks may be buried on the ground or located on the ground surface.
- Pressure Tanks are storage systems which a water pump is controlled by the air pressure in a tightly sealed tank.

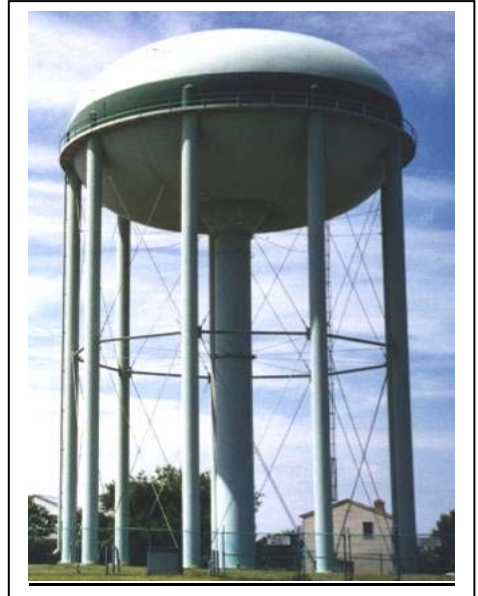

Distribution Pumping

Purpose of Pumps

The purpose of a distribution pump is to provide the energy necessary to lift water from lower elevations to higher elevations.

Valves

Purpose of Valves

Valves have many uses in the distribution system. Valves are commonly used to stop flow, regulate flow, drain lines or isolate a section of line. These valves can be operated manually or by motorized controls that may be operated through a remote.

- The primary purpose of valves is to allow for isolation of mains or sections of main within the network.
- Valves shall be exercised and properly maintained. In order to avoid water hammer, valves shall be opened and closed slowly.

Meters

Purpose of Meters

Meters measure, display, and record the amount of water that passes through a distribution system component.

Meter Uses

Typical applications of meters in a distribution network include:

- Measuring the amount of water supplied to the system.
- Measuring the amount of water supplied to a particular area of the system, including through a pump station or control valve.

- ❑ Measuring the amount of water used by a customer, for billing purposes.
- ❑ Monitoring unaccounted-for water in a distribution network.

Types of Meters

Meters can usually be classified as small-flow meters, large flow meters, and combination large and small flow meters.

- ❑ Displacement Meters
 - Commonly used as customer service meters.
 - Typically have diameters of 2-inches or less.
 - Generally used to measure low flow rates.
 - Have limitations at very high flows.



Figure 4.1 - Displacement Meter⁸

- ❑ Velocity Meters
 - Commonly used in pump stations, industrial facilities, and large diameter mains to measure high rates of flow.
 - Do not accurately measure low flow rates.
 - Include the Venturi, Turbine, and Propeller type meters.

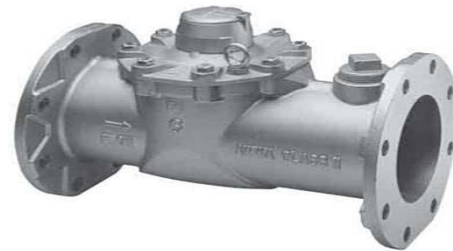

Figure 4.2 – Velocity Meter⁹

- ❑ Compound Meters
 - Commonly used to measure flow at apartment complexes, schools, and industries that can typically have high peaks in water use compared with daily averages.
 - Composite of the displacement and velocity meters.
 - Used to measure flowrates that vary widely.



Figure 4.3 – Compound Meter¹⁰

- ❑ Electric Meters
 - Measure flow magnetically (mag meter) or sonically.
 - Highly accurate if properly located.



Figure 4.4 – Electronic Meter¹¹

- ❑ Proportional Meters
 - Measure high flow rates at locations such as fire service lines.
 - Do not measure low flows accurately.



Figure 4.5 - Proportional Meter¹²

Fire Hydrants

Purpose of Fire Hydrants

Hydrants are an important part of the distribution system.

- ❑ The primary purpose of a fire hydrant is to provide water at high flow rates to aid in extinguishing fires.
- ❑ Fire hydrants can also be used for flushing pipelines and for supplying water to water trucks and construction equipment.

Types of Fire Hydrants

- Dry-barrel hydrants
 - Include a shut-off valve at the base of the hydrant that allows all water in the barrel of the hydrant to drain to prevent damage from freezing.

- Wet-barrel hydrants
 - Have a shut-off valve at the outlet and can only be used in areas where freezing is not a concern.



Figure 4.6 – Dry Barrel Hydrant¹³

Nozzles

- Hydrants generally have three nozzles
 - Two 2 ½-inch nozzles, and
 - One 4 ½ -inch nozzle (pumper connection).

- Protective caps for the nozzle heads are necessary to safeguard the nozzle threads.

Locations of Fire Hydrants

- Hydrants should be easily accessible.

- The maximum distance between hydrants in a distribution network should be approximately 500 feet, depending on the area served.

Backflow Prevention



Backflow—is the flow of water, or mixture of water and other substances, from a source other than an intended source into the distribution network. Backflow can occur when the pressure at the unintended source, often a customer connection, is greater than the pressure in the distribution network.

Purpose of Backflow Prevention

To prevent potential contaminants from being introduced to the distribution network by the reverse flow of water from a source of questionable water quality.

Types of Backflow Prevention Devices

- A physical air gap or separation between the backflow source and the distribution network.
- A reduced pressure device (double-check valve with relief valve as added redundancy).
- A double-check valve assembly.

Pressure and Head



Pressure - the force per unit of area. Pressure is commonly expressed in units of pounds per square inch (psi).



Pressure Head - the vertical distance from a free water surface to a point below the surface (i.e., pressure increases with increasing depth). Pressure head is commonly expressed in units of feet of water (ft).



Relation between Head and Pressure

Pressure, psi = Pressure Head, ft \div 2.31, or

Pressure, psi \times 2.31 = Pressure Head, ft

Pressure is a function of the height of water. Every 2.31 feet of water exerts 1 pound of pressure at the bottom of the base of the container.

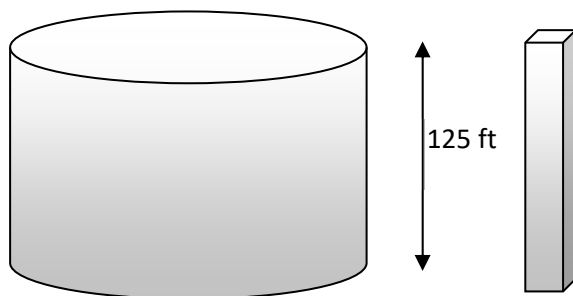

How much pressure does water exert on both tanks if they are filled to the top (psi)?

Note: pressure is not affected by the volume of the tank, only the height. Both tanks are the same height, therefore both tanks will exert the same amount of pressure on 1 square inch.

$$\text{psi} = \frac{1 \text{ psi}}{2.31 \text{ ft}} \times \frac{125 \text{ ft}}{1} = \frac{125 \text{ psi}}{2.31 \text{ ft}} = 54.1 \text{ psi}$$

Example #1:

What would the pressure head in feet be on a fire hydrant if a pressure gauge on that fire hydrant read 155 psi?

$$\begin{aligned} \text{ft} &= \frac{2.31 \text{ ft}}{1 \text{ psi}} \times 155 \text{ psi} \\ &= (2.31) (155) \\ &= 358.05 \text{ Feet} \end{aligned}$$

Practice Problem: A pressure gauge at the bottom of an 80 foot tall, 16 foot diameter tank reads 28.2 psi. How many feet of water are in the tank?

$$? \text{ft} = \frac{2.31 \text{ ft}}{1 \text{ psi}} \times 28.2 \text{ psi} = \underline{\hspace{2cm}} \text{ ft}$$

Note: Remember pressure is not affected by volume, only height.

Example #2:

What would the pressure head in psi be on a fire hydrant if a pressure gauge on that fire hydrant read 258 feet?

$$\text{psi} = \frac{1 \text{ psi}}{2.31 \text{ ft}} \times 258 \text{ ft} = \frac{258}{2.31} = 111.7 \text{ psi}$$

Customers and Demands

Terms and Definitions



Consumption—refers to actual (metered) or estimated water uses within a distribution network. Consumption includes **metered or estimated customer usage** and can also include authorized uses that can be estimated such as **fire fighting, main flushing, and street cleaning**.



Unaccounted-for Water— is the **difference between the amount of water produced and the amount of water metered for billing purposes**. It generally refers to water used or lost from the distribution network that cannot be estimated such as water lost through main breaks or leaks, inaccurate meters, or theft of water. Other examples may be sites that never had meters installed such as libraries, schools, and churches.



System Demand—is the total amount of water supplied to the system, including consumption and unaccounted-for water. System demand is commonly referred to in units of gallons per day (gpd).



Leak Detection—programs are a necessary task in a distribution system. The cost of treating water and never receiving any income from the water is foolish. Unaccounted for water (the difference between net water produced and total water metered) should not exceed 15%. All services should be metered and accounted for each month.

Examples to determine the amount of non-revenue water (unaccounted for) are below:

Example #1

ABC water treated 96,000,000 gallons of water during December of 2012. Records indicate that ABC billed 88,673,249 gallons for December of 2012. What is their percent of water loss?

$$96,000,000 \text{ gallons} - 88,673,249 \text{ gallons} = 7,326,751 \text{ gallons}$$

$$\frac{7,326,751 \text{ gallons}}{96,000,000 \text{ gallons}} \times 100 = 7.6 \% \text{ or } 8\% \text{ Unaccounted for water loss}$$

Example #2

The master meter for a system shows a monthly total of 700,000 gallons. 600,000 gallons were used for billing. Another 30,000 gallons was used for flushing. On top of that, 15,000 gallons were used in a fire episode and an estimated 20,000 gallons were lost to a main break that was repaired that same day. What is the total unaccounted for water loss percentage for the month?

$600,000 + 30,000 + 15,000 + 20,000 = 665,000$ gallons accounted for.

$700,000$ Master Meter Reading - $665,000$ Accounted for Through System = $35,000$ Unaccounted for

$\frac{35,000 \text{ Unaccounted For}}{700,000 \text{ Master Meter}} = 0.05 \times 100 = 5\%$

Practice Problem: In one month a water system produced 5,500,000 gallons of water. Of the total water, 4,500,000 gallons were billed, 250,000 were used for fire protection and 200,000 gallons were used for flushing. What is the total unaccounted for water loss percentage for this month?

Step 1: Add total gallons accounted for (billed, fire protection and flushing)

Gallons Accounted for = _____ (billed) + _____ (fire protection) + _____ (flushing) = _____

Step 2: Subtract "accounted for" from total produced to find "Unaccounted for"

Total Produced = 5,500,000 - _____ (Step 1 Accounted for) = _____ (Unaccounted for)

Step 3: Divide "Unaccounted for" by total produced and multiply by 100 to equal the % unaccounted for

_____ (Step 2 Unaccounted For) = _____ X 100 = _____% Unaccounted for
5,500,000 (Total Produced)

Customer Types

Customers of a water system are often classified by category for record keeping purposes. Typical customer category types are as follows:

- Residential** customers include residential or domestic establishments. Residential customers can also include apartment complexes and mobile home parks.
- Commercial** customers include typical commercial businesses, including stores and office buildings.
- Industrial** customers include larger facilities such as industrial plants and warehouses.
- Other** commonly used customer category types include institutional (schools, hospitals, etc.), bulk (service to another water utility), and municipal (municipal buildings and facilities).

Routine Maintenance and Repairs

Pipeline Maintenance and Repairs

Whenever any part of the distribution system is subject to contamination, such as during repairs, additions, or modifications, disinfection procedures utilizing chlorine must be used before returning it to service. The appropriate procedure to be used for disinfection depends on which part of the distribution system is involved and other factors. There are three key components of a pipeline maintenance program. They are Leak Detection, Main Break Repair and Replacement, and Cleaning and Lining.

Leak Detection

As discussed previously, leak detection programs are a necessary task in a distribution system. The cost of treating water and never receiving any income from the water is foolish. Common methods of leak detection include:

- Direct observation,
- Use of acoustic equipment, and
- Water audits.

Main Break Repair and Replacement

Main breaks are caused by unbalanced forces exerted on a pipeline, which may result from events such as subsidence, earthquake, and freeze/thaw.

- Detection of Main Breaks
 - Physical observations.
 - Customer complaints of low pressure.
 - Observation of non-typical system records.
- Main Break Response Steps
 - Locate the leak.
 - Make preliminary assessment of the situation, including identifying procedures to isolate the break and the corresponding effects to customer services.
 - Isolate the leak.
 - Prior to beginning any excavation, you must identify and locate potential underground utilities. In Pennsylvania this was referred to as a PA One Call. This has now been replaced with 811.

- Make full assessment of the situation, including traffic control, finalizing the repair method, and inspections. If there is a loss of positive water pressure that is caused by a main break, repair or replacement and the operator sees evidence of contamination or he suspects a high risk of contamination, **DEP should be notified within 1 hour** of this investigation. Water supply personnel should follow DEP's *"Policy for Determining When Loss of Positive Pressure Situations in the Distribution System Require One-Hour Reporting to DEP and Issuing Tier 1 Public Notification."* (393-2129-003)
- Repair and test, including flushing and disinfection. This water will be heavily chlorinated. You will need to be aware of where you are going to flush this water. If you are going to flush it to the sewer plant, you need to make them aware. Remember, if there is any question as to whether the water could cause any damage to persons, property, or the environment, an adequate amount of reducing agent (like sodium sulfite or sodium bisulfate) should be used to neutralize the chlorine. Prior to any discharges, the DEP Clean Water program must be notified. Additionally, sodium thiosulfate must be added to the bacteriological sample to remove/neutralize the chlorine residual.
- Return main to service and restore site.
- Develop a main break report/repair log.

Cleaning and Lining

Cleaning and lining of water mains is performed to improve water quality and increase the hydraulic capacity of pipelines. These can result in increased flows and pressures and reduction of pump power costs.

Storage Tank Maintenance

Storage tank maintenance is relatively simple. However, every tank must be periodically inspected. Inspection steps include:

- Prepare for maintenance – drain all the water, clean scale, remove dirt and growth and repair loose rivets and weld damaged seams.
- Paint – to prevent rust, painting should begin as soon as possible after the structure is cleaned and repaired.
- Cure – The tank must be allowed to dry, or cure, before refilling.
- Sterilize – There are several methods to disinfect storage tanks.
- Sample Collection – water samples must be collected before the tank can be placed back into service. Follow proper sampling techniques to ensure the tank can be placed back into service as soon as possible.
Note: the most critical factor in water sampling and analysis is proper sampling techniques. The majority of sampling inaccuracy is the result of poor sampling technique.
- Return to service

Miscellaneous Distribution System Maintenance

Preventative programs help operating personnel keep equipment in satisfactory operating conditions and aid in detecting and correction malfunctions. The way an operator can track preventive maintenance program is by good recordkeeping. Other distribution system equipment which needs maintenance includes:

- Fire Hydrants – flushing is typically done biannually
- Valves – exercising is typically done yearly.
- Pump Maintenance – done as per manufacturer. Should only be done by qualified/authorized person. Remember this is an electrical device; the person performing the maintenance is responsible for following all lock out/tag out procedures.
- Meter - done as per manufacturer.

**Unit 4 Distribution Exercise**

1. Circle those items that are components of a distribution network.
 - a. Pumps
 - b. Grit Chamber
 - c. Storage Facilities
 - d. Intake
 - e. Outfall
 - f. Pipes
 - g. Hydrants
 - h. Valves
 - i. Settling Basin
 - j. Meters

2. How many feet of water are in a water tank that is 35 feet tall with a 50 foot diameter when the pressure gauge at the bottom of the tank reads 10.8 psi?

3. What is the unaccounted for water loss percentage for one month if a water system:

Produced:	8,500,000 gallons
Billed:	7,400,000 gallons
Fire Protection	275,000 gallons
Flushing	100,000 gallons

4. Proper sampling technique is the most critical factor in water sampling.
 - a. True
 - b. False



Unit 4 Key Points

- Drinking water distribution networks provide adequate supplies of safe drinking water and fire flows to areas of the system.
- Distribution network pipes are normally sized to accommodate normal and peak system flows and fire flows without adversely impacting water quality or resulting in an excessive pressure drop.
- The main purpose of a water storage facility is to provide a sufficient amount of water to equalize the daily demands on the water supply system.
- Valves are commonly used to stop flow, regulate flow, drain lines or isolate a section of line.
- Meters measure, display, and record the amount of water that passes through a distribution system component.
- The primary purpose of a fire hydrant is to provide water at high flow rates to aid in extinguishing fires.
- Pressure is a function of the height of water. Every 2.31 feet of water exerts 1 pound of pressure at the bottom of the base of the container.
- Unaccounted-for Water is the difference between the amount of water produced and the amount of water metered for billing purposes.
- When repairing a main break, be sure to follow DEP's "*Policy for Determining When Loss of Positive Pressure Situations in the Distribution System Require One-Hour Reporting to DEP and Issuing Tier 1 Public Notification.*" (393-2129-003)
- Proper sampling technique is the most critical factor in water sampling and analysis.

Unit 5 – Other Hazard Sources at Treatment Plants

Learning Objectives

- List and explain the sources of mechanical hazards and electrical hazards at a Treatment Plant.
- Describe the Lockout/Tagout Program and eye protection requirements as they relate to mechanical hazards in a Treatment Plant.
- Describe the sources and exposure limits for noise in a Treatment Plant and explain the role of a hearing conservation program, noise reduction and hearing protection.
- Name four sources of slip, trip and fall hazards in a Treatment Plant and explain what can be done to minimize or prevent those hazards.
- List six safety considerations when excavating.
- Explain the importance of inspections in regards to excavations.
- Explain the protective systems used for excavations.
- List and explain four soil classifications.
- Describe the characteristics of a Permit-Required Confined Space and the elements of a Confined Space Entry Program.
- List four classes of fire and describe the proper methods for storing and handling flammable material.
- Describe a typical Fire Response Plan and list three sources of reference information related to fire hazard prevention.
- Explain manual lifting limits, proper lifting procedure and the NIOSH lifting equation.
- Describe the Pennsylvania requirements for traffic safety and work zone isolation.

Rotating Equipment

Rotating equipment such as fans, blowers, motors, drive belts, gears, pulleys, blades and shafts pose a significant hazard for fingers, clothing and tools to be caught in the rotating parts, resulting in serious injury.

Guarding

- Rotating shafts, drive belts, couplings, etc. must be guarded and guards should not be removed for any reason other than maintenance.
- OSHA has established machine-guarding requirements in its Machine Guarding Standard (29 CFR 1910.212) and has published a reference booklet, *Concepts and Techniques of Machine Safeguarding* (publication No. 3067), that establishes methods of machine guarding.
- Workers should not wear loose fitting clothing, rings or jewelry when working around this equipment. Also, if you have long hair it should be secured.
- Prior to working on rotating equipment, you must ensure that the equipment is shut down and all energy sources have been locked out in accordance with your facilities lock out/ tag out program. Upon completion of the work and prior to restarting the equipment after a shutdown, follow appropriate restart procedures to include:
 - Removing all tools and materials.
 - Replace all guards.
 - Ensure that all personnel are clear of the equipment.
 - Restart.

Centrifugal Force

- During restart it is important to keep people away from the area as centrifugal force caused by the rotating equipment can throw dusts, oils, loose metal, materials and tools from rotating shafts and couplings.

Crushing

Conveyor Rollers

- Crushing hazards are usually associated with conveyors, presses, hoisting equipment and moving machinery such as trucks and backhoes.
- Again, machine guarding should be employed where practical and extreme caution must be used when working around heavy equipment and hoists. Most conveyors are equipped with an emergency stop—you should be familiar with this device.

Equipment Movement

- Heavy equipment operators must be appropriately trained and authorized for the type of equipment they are operating and they must ensure that the machinery is in good working condition by performing daily inspections.
- Hoisting equipment should be appropriate for the material being lifted or lowered and within the safe lifting limits of the hoist and lifting devices (chains, slings, cables).
- Areas where potential crush hazards exist should be barricaded to prevent people from accidentally being struck.
- Lock out/tag out must be used whenever equipment is to be worked on.

Lockout/Tagout Program

Standard operating procedures should be established for all equipment that has the potential for accidental startup or movement caused by an energy source such as electricity, hydraulics, pneumatic, rotating equipment, gravity, stored energy, pressure and water flow.

Purpose

These procedures usually are in the form of a lockout/tagout program. The purpose of a lockout/tagout program is to ensure that all personnel follow standardized shutdown and startup procedures to prevent accidental equipment start up, energization or release of stored energy and personal injury or property damage. The person performing the maintenance on an electrical device is responsible for the lock out/tagout procedure.

OSHA has established requirements for energy isolation, lockout/tagout in the Control of Hazardous Energy Standard, 29 CFR 1910.147 and the Electrical Safety Standard, 29 CFR 1910.333(b).

A lockout/tagout program should include the following basic elements:

- An energy control program that consists of energy control procedures for each piece of equipment, employee training and periodic inspections to ensure that the appropriate procedures and energy isolation is being performed.
- Lockout/tagout must be used to provide full protection for workers when performing maintenance or repair on equipment. If the energy isolating device for a piece of equipment is capable of being locked out then the energy control procedure should use a standardized lockout device similar to those shown in the figures below. A lockout device uses a positive means such as a lock, chain, blank flange, wedge, block or slip blind to prevent the energizing of a machine or equipment.

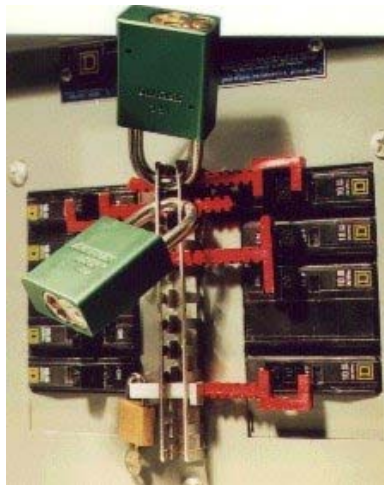

Figure 5.1 Lockout Device for Circuit Breakers¹



Figure 5.2 Typical Lockout Device²

- A standardized tagout system must be used if an energy-isolating device is not capable of being locked out.



A **tagout device** is a prominent warning, such as a tag, which can be securely fastened to an energy-isolating device to indicate that the energy isolating device and equipment are not to be operated until the tag is removed.

- ✦ The tags should have appropriate warning language such as: *Do Not Start, Do Not Open, Do Not Close, Do Not Energize, Do Not Operate*. The following two figures are examples of tagout devices.



Figure 5.3 Warning Tags³

A combination of both a lockout device and tagout device is recommended when possible to ensure the most protection.

Energy Control

- ✦ Energy control procedures should be developed, documented and used.
- ✦ The procedures should state the intended use of the procedure; the steps and responsibility for the placement, removal and transfer of lockout or tagout devices; and the requirement for testing a machine or equipment to ensure that the lockout/tagout devices are effective in controlling the hazardous energy.

Training

- ✦ Training should be provided to all employees that will be performing maintenance or may be affected by the maintenance.

- The training should include the purpose and function of the energy control program and the procedures for the safe application, use, and removal of the energy controls such as locks or tags.

Sample Lockout/Tagout Procedure

A sample lockout/tagout procedure at your facility might look something like this:

- An authorized employee who knows the type and extent of energy a piece of equipment uses and the associated hazards will notify all affected employees that a lockout or tagout system is going to be used and the reason why.
- Shut down the equipment by the normal shut down procedure.
- Operate the switch, valve or other energy-isolating device to ensure that the equipment is isolated from its energy source.
- Ensure that stored energy that may be in springs; elevated equipment parts (gravity); rotating flywheels; hydraulic systems; pneumatic systems; or gas, steam or water pressure is dissipated or controlled by venting, bleeding, blocking or repositioning.
- Apply the lockout or tagout device in accordance with your procedures.
- Perform a final energy isolation test by operating the start button or normal operating controls as a check to make sure that the energy source is isolated. This should only be done after making sure that no personnel are exposed and all tools and equipment are out of the area of operation. After completing the test make sure that all operating controls are reset to the neutral or off position.
- Proceed with the necessary maintenance or repair work.
- Upon completion of the work, remove all tools, reinstall the guards, and clear the area of all personnel.
- Remove the lockout or tagout device and restore energy to the equipment.



How does the lockout/tagout procedure at your plant differ from the sample procedure above?

Outside Contractors

- ✦ It is extremely important that any contractors brought into your facility to perform work be familiar with that lockout/tagout program and procedures at your facility.
- ✦ Communication and coordination must be established between your facility and contractors when shutting down or restarting energized equipment. Prior to the start of any contractor work at your facility a meeting should be held to review the equipment to be shutdown, the schedule, the lockout/tagout procedures to be used, the restart time and the restart procedures.
- 🔑 Never remove a lock or tag unless it is your own and you have followed the appropriate procedures.

Eye Protection

Requirements

- ✦ Eye protection should be worn whenever there is a potential for flying objects, debris or exposure to chemicals or hazardous light radiation from welding or cutting.
- ✦ Eye protection should conform to the requirements of ANSI Z87.1 – 1989, American National Standard Practice for Occupational and Educational Eye and Face Protection.

Welding Lens Shades

- ✦ Lens shades used for protection against radiant energy during welding or cutting should be appropriate for the type of activity being performed and in accordance to guidelines established in OSHA standards.

Serious injury from electrical shock often occurs to personnel who attempt to repair or troubleshoot electrical equipment when not qualified or authorized to perform work on the equipment.



It is important to keep in mind that all electrical systems are considered to be energized until a qualified electrician verifies that it is de-energized and, therefore, you must not perform work on electrical equipment unless you are qualified and authorized to do so.

A qualified person is one who has specific training in the following:

- Distinguishing live exposed parts from other parts of electrical equipment.
- Determining the nominal voltage of exposed live electrical parts.
- Determining the clearance distances required for working with or near various voltage lines.

The most common shock-related injury is a burn. Electrical accident burns take three forms and can occur simultaneously.

- Electrical burns result from electric current flowing through body tissue or bone. The heat generated by the current flow through the body causes the tissue damage. Electrical burns are one of the most serious injuries and should be given immediate attention.
- Arc burns, or flash burns, result from high temperatures near the body caused by an electric arc or explosion.
- Thermal contact burns occur when the skin contacts hot surfaces of overheated electric conductors, conduits, or other energized equipment. This can also cause clothing to ignite and produce additional thermal burns.

Electric shock can also cause secondary injuries such as bruises, bone fractures and death as a result of falls or striking objects caused by electric shock induced involuntary muscle contractions.

Electrical Hazard Control

Electric arcs caused by short circuits can cause injury or start a fire. High-energy arcs can damage equipment and cause fragmented metal to fly in all directions. Even low energy arcs are capable of causing violent explosions in atmospheres containing flammable gases, vapors or combustible dusts.

Electrical accidents are typically the result of unsafe equipment or installation, environmental effects and unsafe work practices.

Electrical hazards can be controlled by:

✦ **Insulation**

Insulation such as glass, mica, rubber and plastic is used on conductors to prevent shock, fire, and short circuits. Before you work with electrical equipment, especially power tools and extension cords always check the insulation before connecting to a power source to be sure that there are no exposed wires.

✦ **Guarding**

Guarding against accidental contact must be provided on the live parts of electrical equipment at 50 volts or more. Guarding is usually achieved by: 1) location in a room, vault or enclosure accessible only to qualified persons, 2) using permanent partitions or screens to keep unqualified personnel away, 3) location on a balcony or platform elevated and arranged to exclude unauthorized personnel, or 3) elevation of 8 feet or more above the floor or work surface. Also, entrances to rooms or other guarded locations with exposed live parts must be posted with conspicuous warning signs.

✦ **Grounding**

This is a secondary means of protection in which an intentional conductive connection is made between an electrical circuit and the ground or ground plane. By grounding a tool or electrical system a low-resistant path to the earth is created to prevent the buildup of voltages that may cause a hazard. It is important that all electrical service and equipment be appropriately grounded.

✦ **Electrical Protective Devices**

These are designed to automatically limit or stop the flow of electricity in the event of a ground-fault, overload or short circuit in a wiring system. These devices include fuses, circuit breakers and ground-fault circuit interrupters (GFCI). Fuses and circuit breakers are over-current devices that are used in circuits to limit the amount of current a circuit will carry. When the amount of current flow becomes unsafe they automatically break the circuit. A GFCI is designed to shutoff electric power within about 1/40 of a second by comparing the amount of current going to the equipment to the amount of current returning. If there is a difference of more than 6 milliamperes, the GFCI interrupts the current in time to prevent electrocution. GFCIs should be used in wet locations, on extension cords and during construction activities.

✦ **Safe Work Practices**

These must be employed by all plant personnel when working with or around electrical equipment. Work practices may include deenergizing electric equipment before inspecting or making repairs, using only tools that are in good repair, using good judgment when working near energized lines and using the right protective equipment.

✦ Deenergizing Electrical Equipment (Lockout/Tagout)

Deenergizing is essential prior to performing any inspection or repair on electrical equipment, even on low voltage circuits. The current must be turned off at the source and locked in the off position. Also, the switch or controls of the equipment or machine being serviced should be locked out or tagged. Only qualified electricians familiar with lockout/tagout procedures should be authorized to work on electrical equipment.

✦ Tools

Tools such as electric drills and saws must be regularly maintained and in proper working order to maximize your safety. Inspect the tool prior to use and remove it from service if any defects, such as broken insulation, frayed wires, broken plug, no ground plug or cracked casing are found. Tools used for electrical safety protection such as lineman's gloves, insulating blankets and hot sticks must be maintained, inspected routinely and designed to handle the voltage and stresses to which they will be exposed.

✦ Overhead/Underground Power Lines

These must only be worked on by qualified electricians. The lines must be deenergized and grounded by the owner or operator of the lines or other protective measures such as guarding or insulating must be provided. Unqualified workers must keep themselves, tools and equipment (e.g. backhoe) at least 10 feet away from overhead/underground power lines. If the voltage is over 50,000 volts then the safe distance must be increased 4 inches for each additional 10,000 volts.

✦ Protective Equipment

Protective Equipment must be used if your job requires you to work directly with electricity. This equipment includes rubber insulating gloves, hoods, sleeves, matting, blankets, line hose, and protective helmets, all of which must be rated for the particular voltage to be worked on.

✦ Good Judgment

Good judgment and common sense is your best defense against electrical hazards. Make sure that you are familiar with safety procedures for your particular job. Make sure you maintain a safe distance from energized electrical equipment. When you must work around electrical equipment keep in mind these basic procedures:

- Have the equipment deenergized by a qualified person.
- Ensure the equipment remains deenergized by using lockout/tagout procedures.
- Use insulating protective equipment.
- Maintain a safe distance from energized parts.

Sources

- ✦ Treatment plant operation and maintenance activities expose workers to a variety of intermittent or continuous high noise sources. These include: pumps, motors, blowers, compressors and hand tools. You should be aware of the work activities that you perform that may expose you to excessive noise levels.
- ✦ Remember that reducing your noise exposure is important not only to prevent permanent hearing loss but also to ensure that you can hear desired sounds such as speech and warning signals.

Exposure Limits

- ✦ The OSHA Occupational Noise Standard found in 29 CFR 1910.95 establishes an 8-hour time weighted average (TWA) noise exposure level of 90 decibels on the A-weighted scale (dBA), with an action level of 85 dBA, and a maximum noise level that should never be exceeded of 115 dBA. In general if you have to shout or cannot hear someone talking in a normal voice then the noise level can be assumed to be excessive.

Monitoring

- ✦ Plant noise surveys should be performed in high noise areas and for activities (e.g. using a jack hammer) to determine the noise level.
- ✦ Monitoring should be performed using a sound level meter set to the A-weighted scale by a person who has been trained to use the meter.
- ✦ Monitoring should be performed periodically and when new equipment is added to the plant.

Hearing Conservation Program

- ✦ At 85 dBA, exposed workers should be placed into a hearing conservation program that includes annual audiometric (hearing) testing, noise reduction efforts, noise monitoring, the provision and use of hearing protection, employee training and record keeping.

Noise Reduction and Hearing Protection

- ✚ Ideally, excessive noise sources should be eliminated or reduced by engineering or administrative controls such as:
 - Replacing equipment with less noisy equipment.
 - Enclosure of the noise source.
 - Preventive maintenance.
 - Sound proofing or dampening materials.

- ✚ When these efforts are not effective, employees must be provided with hearing protection in the form of earplugs or muffs with an adequate noise reduction rating (NRR) to reduce noise exposure to acceptable levels.

- ✚ To calculate the noise reduction provided by a particular hearing protection device, take the NRR of the device and subtract 7 dBA from it. Then, subtract that number from the measured noise exposure.



Calculation

A motor produces a sound level of 93 dBA and you have been provided with earplugs with an NRR of 25. What would the effective noise reduction from the earplugs be?

Walking/Working Surfaces

Walking and working surfaces in treatment plants are inherent sources of slip, trip and fall hazards.

- Ladders, walkways and stairs are continuously subjected to wet conditions and with the addition of slippery polymers used in the process, these areas can become even more hazardous. Even small polymer spills can create extremely slippery conditions on walking and working surfaces.
- Good housekeeping and the maintenance of clean dry floors and walkways are essential to reducing slip hazards.
- Make sure that you have good footwear with adequate tread.
- Floor and grate openings, especially during maintenance and repair activities, present trip and fall hazards. These opening should be protected by placing covers labeled "hole" or providing a guardrail around the opening.

Stairs, Ladders and Scaffolds

- Stairs must be kept dry, free of debris, equipment and materials that create a tripping hazard and must be properly illuminated.
- Ladders must be maintained in good condition. Ensure that fixed metal ladders that serve as access to manholes or chambers are free of corrosion and are dry.
- Portable extension and stepladders should be used appropriately and you should ascend and descend ladders using both feet and both hands. Raise and lower tools and equipment by a tag line.
- Portable ladders should be placed on solid footing at a pitch so that the horizontal distance from the top support to the foot of the ladder is one quarter of the working length of the ladder (4 to 1 rule). The ladder should extend at least 3 feet above the landing and/or be secured from falling. Portable ladders must not be used in a horizontal position as platforms, runways or scaffolds.
- Metal ladders should never be used around energized electrical equipment.

Working at Elevations

- Scaffolds must be erected by qualified personnel on solid, level, rigid footing capable of withstanding the maximum intended load.
- Guardrails, midrails and a toeboard must be provided when scaffolds are greater than 4 feet high or employees must be provided with other means of fall protection.
- Make sure that the required clearance, 10 feet minimum, is provided from energized electrical lines.
- Refer to the OSHA Safety Requirements for Scaffolding, 29 CFR 1910.28 for additional information on scaffold erection and use.

Working Above 4 Feet or Adjacent to Water or Hazardous Equipment

- Working surfaces that present a fall hazard of greater than 4 feet must be protected with a guardrail system or employees must be provided with a personal fall protection device.
- Working on top of tanks, walkways roofs, and other elevated surfaces more than 4 feet or when working above open tanks or hazardous machinery requires the provision of fall protection.
- Fall protection comes in various forms such as:
 - ▶ Guard rails, which typically includes a top rail at a height of about 42 inches and capable of withstanding 200 pounds of force.
 - ▶ A midrail at about the midway point between the top rail and working surface.
 - ▶ A toe board to prevent tools and/or equipment from falling.
 - ▶ Personal fall arrest systems, which include a full body harness, a shock absorbing lanyard and an anchorage capable of withstanding 5,000 pounds of force.
 - ▶ Aerial lifts, which are an excellent means to gain access to elevated work areas. Make sure that the aerial lift is in good working order, provided with a guardrail system and that you have been trained on how to use the lift. Also, when working on an aerial lift you must wear a full body harness attached by lanyard to the lift. Never step on top of the aerial lift railings or use a ladder to gain additional height. Make sure that the required clearance, 10 feet minimum, is provided from energized electrical lines.
 - ▶ Safety nets, which can also be used for fall protection and to catch debris and tools/equipment that might fall. Safety nets are typically not feasible for normal plant operations and maintenance.

For additional fall protection requirements and methods refer to the OSHA Standards on Guarding floor and Wall openings 29 CFR 1910.23 and Fall Protection (29 CFR 1926 Subpart M).

- Many times you will be required to work above or adjacent to open tanks. Working in these locations exposes you to potential fall hazards that may lead to drowning.
 - A United States Coast Guard Approved life vest/jacket should be worn when fall protection, such as a guardrail system, is not provided.
 - Life saving devices such as life rings must be available for emergency rescue.
 - These areas should be provided with fall protection in the form of guardrails or personal fall protection.

- ✦ Prior to beginning any excavation, you must identify and locate potential underground utilities such as gas lines, water lines, electrical conduit and TV and cable lines. Typically, this can be handled by reviewing facility utility drawings and the Pennsylvania One Call System at 1-800-242-1776. **Remember: Call Before You Dig.** The free one call system is an essential resource for identifying underground utilities. You can also call 811 and your call will be transferred to your local call center.
- ✦ Be familiar with the Uniform Temporary Markings for underground utilities as described below and are shown in the following figure.

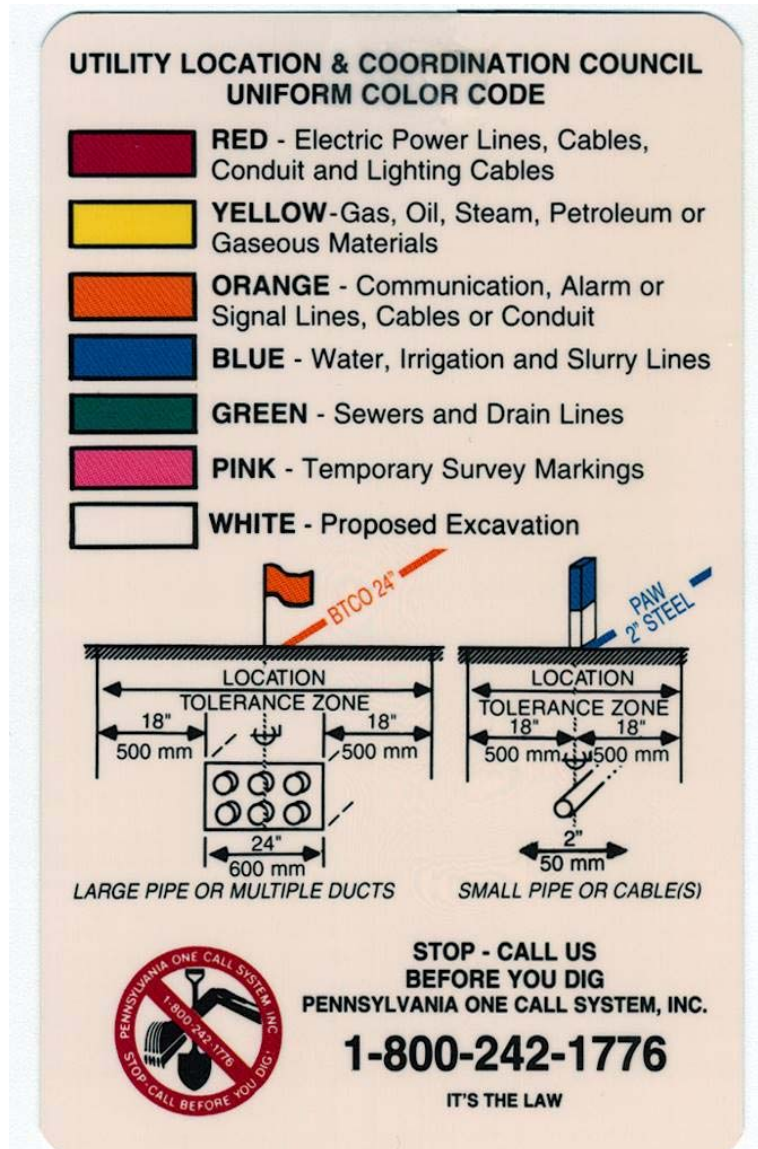

Figure 5.4 PA One Call System, Inc. Utility Markings⁴

Considerations

Additional considerations prior to excavation include:

- Surface encumbrances that are located in the area of your proposed excavation that may pose a hazard must be removed or supported to protect workers.
- Underground installations as described above must be identified and located. These must be supported, protected or removed if necessary to safeguard workers.
- General excavation requirements must also be considered. This includes the provision of access and egress for personnel as well as equipment. Ramps for access/egress must be designed by a competent person and be capable of handling the intended loads. A stairway, ladder or ramp must be provided within 25 lateral feet of employees in trench excavations greater than 4 feet.
- Workers must remain clear of loads handled by lifting or digging equipment to avoid being struck by falling objects or spillage.
- When mobile equipment is operated adjacent to an excavation or is required to approach the edge, a warning system must be used such as barricades, hand or mechanical signals, or stop logs.
- In excavations greater than 4 feet consideration should be made for the potential for hazardous atmospheres. If there is a potential for hazardous atmospheres either from oxygen deficiency, accumulation of combustion gases from excavation equipment or hazardous materials from contaminated soils or adjacent locations, then atmospheric monitoring must be performed prior to employees entering the excavation. Also, emergency rescue equipment such as an SCBA, safety harness and line or basket stretcher must be provided and readily available.
- Water accumulation should not be permitted in an excavation in which personnel are working.
- Adjacent structures such as buildings, walls and sidewalks must not be undermined unless they are shored, braced or underpinned to ensure stability and protection of excavation workers unless a registered professional engineer determines that there is no hazard posed.
- Loose rock or soil must be kept from falling onto workers inside the excavation. This can be accomplished by scaling the sidewalls to remove loose soils or rocks or installing protective barricades. Excavation spoils should be placed no closer than 2 feet from the edge of the excavation or shielded to prevent the material from falling back into the excavation.
- Fall protection should be provided for employees who must cross over excavations greater than 6 feet deep. This should consist of walkways with appropriate guardrails.

Inspections

- Inspections must be made by a competent person each day prior to the start of work and as needed throughout the shift.
- The inspections should focus on checking for evidence of possible cave in, indications of failure of protective systems, hazardous atmospheres, or other hazardous conditions. If hazards are identified the competent person must ensure that action has been taken to protect exposed workers.

Soil Classifications

Soil classification must be based on the results of at least one visual and one manual analysis in accordance with accepted methods. The soil classifications are defined as:

Stable Rock

- Stable rock is a natural solid mineral matter that can be excavated with vertical sides and remain intact while exposed.

Type A

- Type A soils are cohesive soils with an unconfined, compressive strength of 1.5 tons per square foot (tsf) or greater.
- Examples are clay soils and cemented soils like hardpan.
- Soil cannot be Type A if the soil:
 - Is fissured.
 - Is subject to heavy vibration.
 - Has been previously disturbed.
 - Is part of a sloped, layered system where the layers dip into the excavation on a slope of four horizontal to one vertical.

Type B

Type B soils consist of:

- Cohesive soils with an unconfined, compressive strength greater than 0.5 tsf but less than 1.5 tsf.
- Granular cohesionless soils.
- Previously disturbed soils other than Type C.
- Type A soil that is fissured or subject to vibration.
- Unstable, dry rock.
- Material that is part of a sloped, layered system where the layers dip into the excavation on a slope less steep than four horizontal to one vertical, but only if the material would otherwise be classified Type B.

Type C

Type C soils consist of:

- Cohesive soil with an unconfined, compressive strength of 0.5 tsf or less.
- Granular soils.
- Submerged soil or soil from which water is freely seeping.
- Submerged rock that is not stable.
- Material in a sloped, layered system where the layers dip into the excavation on a slope of four horizontal to one vertical or steeper.

Protective Systems

- Protective systems such as sloping, shoring or shielding must be provided for excavations that are deeper than 5 feet in order to protect workers within the excavation from cave-in.
- The OSHA Standard for Requirements for Protective Systems, 29 CFR 1926.652 establishes this requirement and details the methods and types of protective systems.
- It is important to note that protective systems for excavations greater than 20 feet deep must be designed by a registered professional engineer.

The following is a brief summary of each of these systems in order to provide you with the basic fundamentals.

Sloping and Benching

- Sloping and benching consists of the removal of the trench wall at a specific slope based on the type of soil being excavated.
- A good rule of thumb is to slope the sidewalls at least one and one half foot back for every one foot in depth on both sides of the trench unless the soils have been classified as to the type and the options provided in the OSHA Standard have been selected by a competent person.
- Figure 5.5 on the next page shows the sloping and benching options by soil type that are provided in the OSHA Standard.

**FIGURE B-1.2
EXCAVATIONS MADE IN TYPE B SOIL**

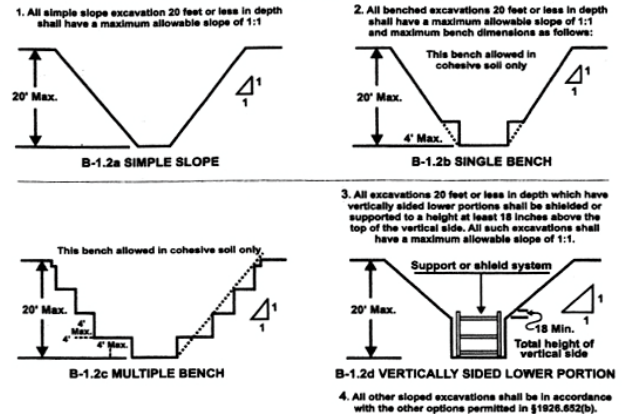

Table B-1 - Maximum Allowable Slopes

Soil or Rock Type	Maximum Allowable Slopes (H:V) ¹ For Excavations Less Than 20 Feet Deep ²
Stable Rock	Vertical (90 Deg.)
Type A ²	3/4:1 (53 Deg.)
Type B	1:1 (45 Deg.)
Type C	1 1/2:1 (34 Deg.)

- Numbers shown in parentheses next to maximum allowable slopes are angles expressed in degrees from the horizontal. Angles have been rounded off.
- A short-term maximum allowable slope of 1/2H:1V (63 degrees) is allowed in excavations in Type A soil that are 12 feet (3.67 m) or less in depth. Short-term maximum allowable slopes for excavations greater than 12 feet (3.67 m) in depth shall be 3/4H:1V (53 degrees).
- Sloping or benching for excavations greater than 20 feet deep shall be designed by a registered professional engineer.

**FIGURE B-1
SLOPE CONFIGURATIONS**

(All slopes stated below are in the horizontal to vertical ratio)
B-1.1 EXCAVATIONS MADE IN TYPE A SOIL

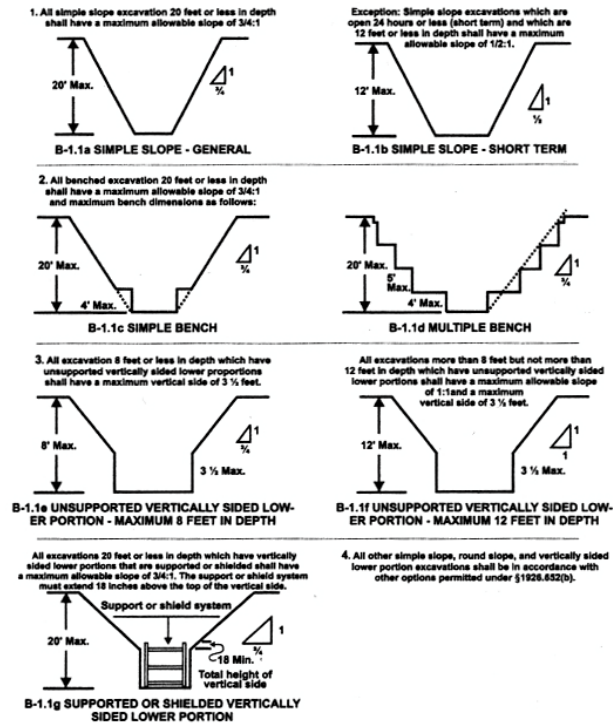

**FIGURE B-1.3
EXCAVATIONS MADE IN TYPE C SOIL**

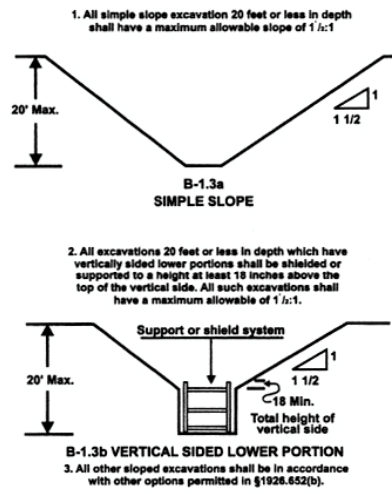

**FIGURE B-1.4
EXCAVATIONS MADE IN LAYERED SOILS**

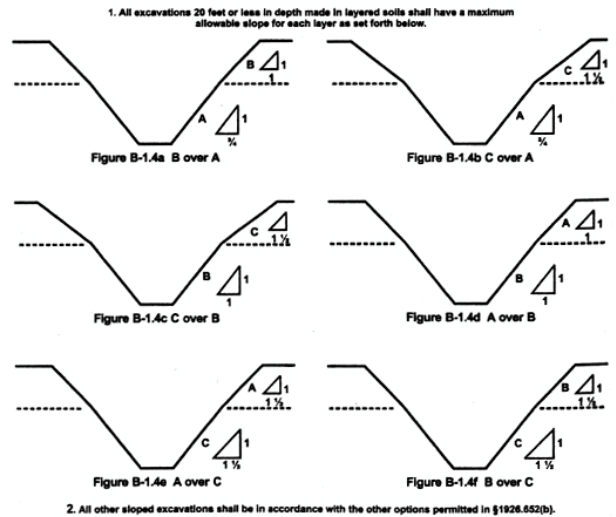

Figure 5.5 OSHA Slope Tables⁵

Shoring

- Shoring is a framework of timber and/or metal that is designed to support the walls of a trench.
- Sheeting, consisting of wooden sheets or metal plates, is placed against the side of the trench to hold back the walls. Uprights placed vertically along the face of the trench wall are used to support the sheeting. Stringers or wales are placed horizontally along the uprights in which trench braces are attached to prevent cave-in.

Shielding

- This uses a two-sided, braced box sometimes referred to as a drag shield or trench box, which is open at the top, bottom and ends.
- The trench box is literally pulled through the excavation as the trench is being dug.
- It is important to remember that you must always stay within the walls of the trench box and never leave the area of the shields protection while inside the trench.

It is important that you become familiar with the confined spaces and the hazards associated with your facility and that you have been thoroughly trained on the confined space entry procedures at your facility.



Never enter a confined space without following the appropriate procedures.

A confined space is defined as a space that meets the following three criteria:

- Is large enough and so configured that a person can bodily enter and perform their assigned work.
- Has a limited or restricted means for entry or exit.
- Is not designed for continuous worker occupancy.

Generally, if you cannot walk upright into a space and you must duck, crawl, climb, or squeeze into a space, it is considered a confined space.

Confined spaces are further classified either as “permit-required” or “non-permit required.”

Characteristics of a Permit-Required Confined Space



A **permit-required confined space** is a confined space that has one or more of the following hazardous characteristics:

- it contains or has the potential to contain a hazardous atmosphere such as oxygen deficiency, toxicity or flammability;
- it contains a material that has the potential to engulf an entrant such as water;
- it has an internal configuration such that an entrant could be trapped or asphyxiated by inwardly converging walls or by a floor that slopes downward and tapers to a smaller cross section such as a hopper or bin;
- it contains any other recognized serious safety or health hazard.



A **non-permit required confined space** does not contain or have the potential to contain, any hazard capable of causing death or serious physical harm.

Atmospheric Testing

Potentially hazardous atmospheres present a threat of causing death, injury, illness or incapacitation due to flammable/explosive, toxic or oxygen deficient atmospheres.

The primary atmospheric concerns associated with treatment plants are:

- Oxygen deficiency (less than 19.5% oxygen) from metal corrosion, oxygen scavenging or depletion by another gas.
- Flammability/explosive atmosphere from methane gas, hydrogen sulfide and fuels.

- A toxic atmosphere from hydrogen sulfide, chlorine and other process chemicals.

Monitoring

- It is important to keep in mind that the work you perform within a confined space may create a hazardous atmosphere. Welding, painting, solvent cleaning, pipe grouting or use of power tools with combustion engines can all produce hazardous contaminants that will create a hazardous atmosphere. Therefore, it is imperative that the atmosphere of a confined space that you will be entering is checked using reliable, calibrated direct-reading instruments prior to and during your entry into a confined space.
- The monitoring must be performed by an individual who is knowledgeable about the potential confined space hazards and air monitoring procedures.
 - Atmospheric monitoring should be performed outside of the confined space in the vicinity of the opening or at potential contaminant sources that may pose a problem and, at stratified levels (top, middle, and bottom) within the confined space.
 - Monitoring should be performed in the following order and acceptable results should be within the acceptable concentrations:

<u>Contaminant</u>	<u>Acceptable Concentration</u>
Oxygen	19.5% - 23.5%
Flammable gases/vapors	>10% of the lower flammable/explosive limit
Potential toxic contaminants:	
Hydrogen sulfide	<10 ppm
Carbon monoxide	<25 ppm
Chlorine	<0.5 ppm
Other contaminants	< the OSHA PEL or ACGIH TLV or other recognized exposure limit

Ventilation

Air monitoring results that are not within the acceptable concentrations will classify the space as a permit-required confined space and appropriate action must be taken to eliminate or control the hazard. This will involve the following:

- Allowing the space to naturally ventilate.
- Use of forced air ventilation.
- Purge the space with an inert gas or water.

The space should be continuously ventilated using explosion proof, forced air blowers.

- The blowers should be set up to either supply fresh air into the space or to exhaust contaminants out of the space (this is especially useful when activities within the space such as welding or painting create a potential hazardous atmosphere) or, a combination of supply and exhaust ventilation.
- It is important to know the density of the potential contaminants in order to properly position ventilation equipment. Heavier than air gases/vapors will sink to the bottom and lighter than air gases /vapors will tend to accumulate at the top of a space and, therefore, ventilation equipment should be positioned accordingly.

Controls

Prior to entry into a confined space all physical hazards must be considered.

- These may include:
 - Electrical.
 - Hazardous energy sources.
 - Power driven equipment.
 - Material or water flow.
 - Fall hazards.
 - Noise exposure.
- These physical hazards must all be controlled prior to entering a confined space.
- Water supply lines should be disconnected, shut off and locked out or blanked to prevent water flow into the space.
- Electrical and other hazardous energy sources must be deenergized and locked out.
- Appropriate personal protective equipment must be worn.

Confined Space Entry Program

Confined space entries should be performed under a facility specific Confined Space Entry Program that establishes:

- Written entry procedures to be followed.
- The responsibilities of each individual involved in confined space entry (entrants, attendants and supervisors).
- The confined space entry permit system to be used.

Permit-required confined spaces can only be entered under a permit system. A Confined Space Entry Permit is a written document that identifies:

- The space to be entered.
- The work to be done within that space.
- The potential hazards associated with the space.
- The hazard control measures taken.
- Documentation of atmospheric testing results.
- Identification of the workers working within the space (entrants).
- The worker serving as the attendant outside the space.
- The competent person who certifies the permit and authorizes the confined space entry and work.

Work within confined spaces can pose serious safety and health hazards if you are uninformed or untrained in confined space hazards and proper entry procedures. Make sure that your plant's confined spaces have been identified and the hazards associated with each space have been identified and assessed and that appropriate procedures have been established to enter and work within a confined space.

The OSHA Permit-Required Confined Space Standard, 29 CFR 1910.146, establishes the requirements for confined space entry programs, permit systems and entry procedures.

The major hazards of fire are the loss of life or the injury of plant employees or others as well the direct property damage to structures and equipment, which can be very costly.



There are also some less obvious consequences of fire. What do you think some of those consequences are?

Every facility should develop and implement a fire prevention plan to minimize the risk of fires and to establish procedures on how to respond to a fire if one occurs.

Classes of Fire

Class A

- Includes ordinary combustibles such as wood, paper and textiles. Class A fire extinguishers are identified with a letter A in a triangle.

Class B

- Includes flammable or combustible liquids such as gasoline, oils, paints and greases. Class B fire extinguishers are identified with a letter B in a square.

Class C

- Are electric fires from wiring and electrical equipment or class A or B fires adjacent to electrical equipment. Class C fire extinguishers are identified with a letter C in a circle.

Class D

- Includes combustible metals such as aluminum, magnesium and titanium. Class D fire extinguishers are identified with a letter D in a five-point star.

Fire Response Plan

Fire response plans should establish the appropriate personnel and responsibilities to respond to a fire. Plant employees should only attempt to extinguish incipient (beginning) stage fires only unless they have received comprehensive, hands-on training under the supervision of an approved fire fighting school. The plan should also include evacuation procedures and routes as well as provision for routine fire evacuation drills.

At minimum, plant workers must be trained on:

- How to recognize the types of fire.
- How to activate the fire alarm system.
- Location, selection and use of the appropriate fire extinguisher.
- How to fight incipient stage fires if required to do so.
- When and how to call for outside assistance.
- When to abandon the fire fight.
- When and how to evacuate the area.

The recommended procedure for fire response upon notification of a fire at your facility should be:

- Alert coworkers and other plant personnel of the fire and activate the alarm system.
- Evacuate the immediate area and/or the entire facility if necessary.
- Contain the fire if possible by turning off valves or shutting down fuel supply.
- Attempt to extinguish the fire with available equipment keeping in mind that only incipient stage fires should be handled by plant personnel if they have been trained to do so.

The OSHA General Industry Standards (29 CFR 1910) should be reviewed and will provide the necessary information to develop a fire prevention and response plan and safe storage and handling procedures.

Storage and Handling of Flammable Material

- Flammable/combustible liquids, solids and gases must be stored and handled appropriately. Storage should be in approved containers and storage areas that are equipped for the amount and type of material. Only the minimum needed amount of material should be stored and used at your facility. Incompatible materials should also be segregated. Flammable liquid containers should be bonded and grounded when transferring the material from one container to another in order to prevent vapor ignition from static spark.
- Flammable storage areas or rooms should be of adequate construction and size for the materials being stored and properly vented to prevent the build-up of vapors. Also, flammable storage areas should be provided with explosion proof electrical equipment such as lights and ventilation to prevent vapor ignition. Ignition source should be eliminated and appropriate fire fighting media (extinguishers, sprinklers, hoses, etc.) provided. Aisles and passageways must be kept clear and free of obstruction to allow for quick exit in case of an emergency and access by firefighters and equipment.
- Compressed gases, such as acetylene, should be stored separately from other flammable/combustible materials and separated from oxygen cylinders by at least 20 feet or a fire rated partition. Additional information on compressed gas handling and storage can be obtained from the Compressed Gas Association.
- Treatment processes produce explosive gases such as methane and hydrogen sulfide that pose serious fire and explosion hazards. Areas where these gases can accumulate should be provided with explosion proof electrical equipment and ventilation systems. Monitors should be provided to warn plant personnel of excessive concentrations of flammable gases. Smoking and other sources of ignition such as welding, grinding or cutting should not be performed unless hazardous areas have been checked for flammable gas concentrations, properly ventilated and a hot work permit has been issued.

Additional Chemical Storage Tips

All chemicals shall be stored with regards to chemical compatibility. Secondary containment volumes shall be provided and able to hold the volume of 110% of the largest storage tank. Chemical storage requirements are listed on Safety Data Sheet (SDS) for each chemical. In general:

- Store acids and bases separately.
- Store oxidizers and reducers separately. No smoking, drinking or eating when working with chemicals.
- Store carbon in a clean, dry place in single or double rows with access around every stack for inspections.
- Store chlorine in secure areas with leak detection equipment.
- Handle cylinders and containers carefully, insure cylinders and containers are secured (chained) to prevent tipping/rolling.
- First aid kits, safety showers and eyewash stations should be available and easy to access.

Supplemental Reference Information

Additional sources of information include:

- The International Fire Information Network
- United States Fire Administration.
- National Fire Protection Association.
- OSHA general industry standards.

Manual Lifting Limits

- ✦ Keep in mind your manual lifting limits and ask for help when lifting or moving a heavy object. Reduce or eliminate manual lifting as much as possible.
- ✦ Items that are too heavy to be lifted or moved by hand should be performed by hoists, fork trucks, pallet jacks or other mechanical means.
- ✦ Manhole covers should never be removed using your hands and fingers. Serious hand, finger, and back injuries occur from removing manhole covers. Always use a manhole tool that is especially designed for that purpose.

Proper Lifting Procedure

Remember to use the following lifting procedure help reduce the risk of back injury:

- ✦ Size up the load.
- ✦ Bend at your knees, not your back to pick-up the load.
- ✦ Establish a firm grip on the load.
- ✦ Gradually lift with your legs not your back.
- ✦ Keep the load close to your body.
- ✦ Never twist while lifting.

NIOSH Lifting Equation

The National Institute for Occupational Safety and Health (NIOSH) has developed an equation that can help your facility's safety coordinator to identify and assess hazardous lifting activities.

For more detailed information on the NIOSH lifting equation refer to the NIOSH publication: *Applications Manual for the Revised NIOSH Lifting Equation* by Tom Waters, Vern Putz-Anderson and Arun Garg.

Pennsylvania Requirements

- Prior to starting work in a traffic area be sure to plan out the appropriate traffic control to protect you and your coworkers from vehicular hazards as well as the drivers. Ensure that you are providing adequate warning and protection for your work area by consulting the local police department and the Pennsylvania traffic codes for the required traffic control patterns required in your area. Avoid working during rush hour traffic.
- Make sure that appropriate warning signs, safety cones, barricades and flagmen are provided throughout the duration of your work. Flagmen should use a red warning flag or slow/stop paddle and appropriate hand signals to direct traffic.
- All personnel should wear a reflective safety vest. As added protection, if possible place your work vehicle or "crash truck" (with flashing or revolving amber warning lights on) between your work area and the oncoming traffic. This provides additional visual notification to the traffic of your work area.

**Unit 5 Exercise**

1. Electrical hazards can be controlled by:

- a. Insulation
- b. Guarding
- c. Grounding
- d. Ground-Fault Circuit Devices
- e. All of the above

2. Draw a line to match the fire class with the appropriate type of material to be extinguished.

Fire Class	Type of Material to be Extinguished
Class A	Wiring and electrical equipment
Class B	Combustible metals
Class C	Wood, paper, and textiles
Class D	Gasoline, oils, paints and greases

3. Guarding is not necessary for rotating shafts, drive belts, and couplings.

- a. True
- b. False

4. In general if you have to shout or cannot hear someone talking in a normal voice then the noise level can be assumed to be excessive.

- a. True
- b. False

5. To help reduce the risk of back injury when lifting:

- a. Bend at your knees, not your back to pick-up the load.
- b. Gradually lift with your legs not your back.
- c. Keep the load close to your body.
- d. Never twist while lifting.
- e. All of the above



Unit 5 Key Points – Other Hazard Sources at Treatment Plants

- Follow the recommendations identified within this unit to minimize the hazards within your treatment plant.
- Lockout/tagout programs are designed to prevent accidental equipment start up, energization or release of stored energy and personal injury or property damage.
- The person performing the maintenance on an electrical device is responsible for the lock out/tagout procedure.
- Pa One Call system (also known as 811) is an essential resource for identifying underground utilities.
- Never enter a confined space without following the appropriate procedures.
- Follow the chemical storage requirements on the Safety Data Sheet (SDS) to avoid fire and explosion reactions.
- Refer to Table 5.1 **Chemicals Used in Treatment** located in the Appendix for hazards and symptoms of exposure.

¹ www.safetyinfo.com.

² www.safetyinfo.com.

³ www.safetyinfo.com.

⁴ Pennsylvania One Call System, Inc., reference card, revised January, 1997.

⁵ Excavation Standard 29 CFR 1926 Subpart P, Occupational Safety and Health Administration.

⁶ *Operation of Wastewater Treatment Plants, A Field Study Training Guide*, Vol II, (Sacramento California: California State University, Sacramento Foundation, 1999), p. 238.

Table 5.1 Chemicals Used in Treatment

Chemical	Use	Characteristics	Hazards and Symptoms of Exposure	Exposure Limits
Chlorine	Disinfection and odor control	Usually stored under pressure in cylinders in a liquefied gas form but can also be used in diluted liquid and granular forms. Heavier than air, yellow-green gas with a pungent, irritating odor. Nonflammable but a strong oxidizer.	Exposure to low concentration can cause burning in the eyes, nose, mouth, and throat. Chronic low-level exposure can cause teeth corrosion and susceptibility to tuberculosis and emphysema. Acute exposure to high concentrations can cause coughing, choking, nausea, nose and throat bleeding, respiratory distress, and dermatitis.	OSHA PEL = 1.0 ppm ACGIH TLV = 0.5 ppm NIOSH REL = 0.5 ppm IDLH = 10 ppm
Sodium Hypochlorite	Used in the disinfection process and is usually a safer substitute for chlorine.	Corrosive. Can be a potential fire and explosion hazard.	Causes irritation of the eyes, skin, mouth, and lungs. Prolonged exposure can burn the skin and cause permanent eye and lung damage.	OSHA PEL = Not established ACGIH TLV = Not established NIOSH REL = Not established IDLH = Not established
Chlorine Dioxide	Disinfection and taste and odor control.	A yellow to red gas or a red-brown liquid with an unpleasant odor similar to chlorine and nitric acid. Heavier than air as a gas and is considered flammable. The liquid form is considered a combustible.	Produces eye, nose and throat irritation, coughing, wheezing, bronchitis, and difficulty in breathing.	OSHA PEL = 0.1 ppm ACGIH TLV = 0.1 ppm NIOSH REL = 0.1 ppm IDLH = 5 ppm

APPENDIX

Chemical	Use	Characteristics	Hazards and Symptoms of Exposure	Exposure Limits
Sulfur Dioxide	Dechlorination after disinfection.	A colorless, nonflammable gas with a characteristic, irritating odor. Also a strong oxidizer. Usually shipped as a liquefied compressed gas.	Irritates the eyes, nose, throat, and lungs. Produces rhinitis, choking, cough and bronchial constriction.	OSHA PEL = 5.0 ppm ACGIH TLV = 2.0 ppm NIOSH REL = 2.0 ppm IDLH = 100 ppm
Ferric Chloride	Used as a coagulant.	Acidic solution. Noncombustible.	Irritates (corrosive) the eyes, skin, and mucous membranes. Can produce abdominal pain, diarrhea, vomiting, and possible liver damage.	OSHA PEL = Not established ACGIH TLV = 1.0 mg/m ³ NIOSH REL = 1.0 mg/m ³ IDLH = Not Determined
Bases such as 1) sodium hydroxide (caustic soda), and 2) calcium oxides and 3) calcium hydroxides (limes)	Used for pH adjustment, water softening, sludge conditioning and dewatering, and phosphorous removal.	Colorless to white, odorless solid (flakes, beads, granules, or powder). Noncombustible but reacts violently with water and generates heat, which may produce burns.	The base typically causes eye, nose, throat, and mucous membrane irritation. Respiratory tract irritation, skin and nasal burns. Causes dermatitis.	OSHA PEL = 1) 2.0 mg/m ³ , 2) 5 mg/m ³ , 3) 15 mg/m ³ ACGIH TLV = 1) 2.0 mg/m ³ , 2) 2.0 mg/m ³ , 3) 5 mg/m ³ NIOSH REL = 1) 2.0 mg/m ³ , 2) 2.0 mg/m ³ , 3) 5 mg/m ³ IDLH = 1) 10 mg/m ³ , 2) 25 mg/m ³ , 3) Not determined

APPENDIX

Chemical	Use	Characteristics	Hazards and Symptoms of Exposure	Exposure Limits
Aluminum Sulfate (Alum)	Used as a coagulant.	Used in both powder and liquid form. Creates slippery conditions when combined with water and can produce sulfuric acid.	Irritating to the skin, eyes, respiratory system, and mucous membranes. Can produce skin burns. Prevent skin contact.	OSHA PEL = Not Established ACGIH TLV = 2.0 mg/m ³ NIOSH REL = 5.0 mg/m ³ IDLH = Not determined
Polymers (Acrylamide containing)	Used for sludge conditioning.	Polymers are either in liquid or powder/granular form. They are very slippery, especially when in contact with water, and can cause a walking-surface hazard. Some polymers give off ammonia and formaldehyde vapors.	Acrylamide containing polymers irritate the eyes and skin. Also, can produce muscle weakness, hand sweats, fatigue, lethargy, and reproductive effects. Affects the Central Nervous System and may cause cancer. Absorbed through the skin.	As Acrylamide: OSHA PEL = 0.3 mg/m ³ ACGIH TLV = 0.03 mg/m ³ NIOSH REL = 0.03 mg/m ³ IDLH = 60 mg/m ³
Potassium Permanganate	Disinfection and taste and odor control.	Dark purple crystals with a blue metallic sheen. A flammable and explosion hazard by chemical reaction. A strong oxidizer.	Poison by intravenous or subcutaneous routes. Moderately toxic by ingestion. May cause gastrointestinal effects if ingested.	Not established

APPENDIX

Chemical	Use	Characteristics	Hazards and Symptoms of Exposure	Exposure Limits
Resins (Styrene containing)	Water softening.	Styrene is a colorless to yellow, oily liquid with a sweet floral odor. Considered a flammable liquid.	Causes eye, nose, and respiratory system irritation. Headaches, fatigue, dizziness, unsteady gait, narcosis, dermatitis, liver damage, reproductive effects, and Central Nervous System effects.	OSHA PEL = 100 ppm ACGIH TLV = 20 ppm NIOSH REL = 50 ppm IDLH = 700 ppm
Ozone	Disinfection and taste and odor control.	Colorless to blue gas with a very pungent odor. Nonflammable gas but a powerful oxidizer.	Eye and mucous membrane irritant. Also, causes respiratory system effects.	OSHA PEL = 0.1 ppm ACGIH TLV = 0.08 ppm NIOSH REL = 0.1 ppm IDLH = 5.0 ppm