



**COMMONWEALTH OF PENNSYLVANIA
DEPARTMENT OF ENVIRONMENTAL PROTECTION
AIR QUALITY PROGRAM**

TITLE V/STATE OPERATING PERMIT

Issue Date:	October 3, 2019	Effective Date:	March 18, 2020
Revision Date:	March 18, 2020	Expiration Date:	October 2, 2024
Revision Type:	Amendment		

In accordance with the provisions of the Air Pollution Control Act, the Act of January 8, 1960, P.L. 2119, as amended, and 25 Pa. Code Chapter 127, the Owner, [and Operator if noted] (hereinafter referred to as permittee) identified below is authorized by the Department of Environmental Protection (Department) to operate the air emission source(s) more fully described in this permit. This Facility is subject to all terms and conditions specified in this permit. Nothing in this permit relieves the permittee from its obligations to comply with all applicable Federal, State and Local laws and regulations.

The regulatory or statutory authority for each permit condition is set forth in brackets. All terms and conditions in this permit are federally enforceable applicable requirements unless otherwise designated as "State-Only" or "non-applicable" requirements.

TITLE V Permit No: 15-00010

Federal Tax Id - Plant Code: 20-0653500-1

Owner Information

Name: ARCELORMITTAL PLATE LLC
Mailing Address: 139 MODENARD
COATESVILLE, PA 19320-4036

Plant Information

Plant: ARCELORMITTAL PLATE LLC/COATESVILLE
Location: 15 Chester County 15001 Coatesville City
SIC Code: 3312 Manufacturing - Blast Furnaces And Steel Mills

Responsible Official

Name: CORY CHAPPELL
Title: OPERATIONS MNGR
Phone: (610) 383 - 2000

Permit Contact Person

Name: REZA AJALLI
Title: MGR - ENVIRONMENTAL
Phone: (610) 383 - 2097

[Signature] 
JAMES D. REBARCHAK, SOUTHEAST REGION AIR PROGRAM MANAGER



SECTION A. Table of Contents

Section A. Facility/Source Identification

Table of Contents
Site Inventory List

Section B. General Title V Requirements

- #001 Definitions
- #002 Prohibition of Air Pollution
- #003 Property Rights
- #004 Permit Expiration
- #005 Permit Renewal
- #006 Transfer of Ownership or Operational Control
- #007 Inspection and Entry
- #008 Compliance Requirements
- #009 Need to Halt or Reduce Activity Not a Defense
- #010 Duty to Provide Information
- #011 Reopening and Revising the Title V Permit for Cause
- #012 Reopening a Title V Permit for Cause by EPA
- #013 Operating Permit Application Review by the EPA
- #014 Significant Operating Permit Modifications
- #015 Minor Operating Permit Modifications
- #016 Administrative Operating Permit Amendments
- #017 Severability Clause
- #018 Fee Payment
- #019 Authorization for De Minimis Emission Increases
- #020 Reactivation of Sources
- #021 Circumvention
- #022 Submissions
- #023 Sampling, Testing and Monitoring Procedures
- #024 Recordkeeping Requirements
- #025 Reporting Requirements
- #026 Compliance Certification
- #027 Operational Flexibility
- #028 Risk Management
- #029 Approved Economic Incentives and Emission Trading Programs
- #030 Permit Shield
- #031 Reporting
- #032 Report Format

Section C. Site Level Title V Requirements

- C-I: Restrictions
- C-II: Testing Requirements
- C-III: Monitoring Requirements
- C-IV: Recordkeeping Requirements
- C-V: Reporting Requirements
- C-VI: Work Practice Standards
- C-VII: Additional Requirements
- C-VIII: Compliance Certification
- C-IX: Compliance Schedule

Section D. Source Level Title V Requirements

- D-I: Restrictions
- D-II: Testing Requirements
- D-III: Monitoring Requirements
- D-IV: Recordkeeping Requirements
- D-V: Reporting Requirements



SECTION A. Table of Contents

D-VI: Work Practice Standards
D-VII: Additional Requirements

Note: These same sub-sections are repeated for each source!

Section E. Alternative Operating Scenario(s)

E-I: Restrictions
E-II: Testing Requirements
E-III: Monitoring Requirements
E-IV: Recordkeeping Requirements
E-V: Reporting Requirements
E-VI: Work Practice Standards
E-VII: Additional Requirements

Section F. Emission Restriction Summary

Section G. Miscellaneous

**SECTION A. Site Inventory List**

Source ID	Source Name	Capacity/Throughput	Fuel/Material
035	2-ARC BUILD. BOILERS-6.28MMBTU EACH	6.300 MMBTU/HR	
		12.560 MCF/HR	Natural Gas
055	ELECTRIC MELT SHOP BOILER	62.300 MMBTU/HR	
		62.300 MCF/HR	Natural Gas
104	ELECTRIC FURNACE	177.000 Tons/HR	CARBON/STAINLESS STEEL
		177.000 Tons/HR	ALLOY STEEL
		75.000 MCF/HR	Natural Gas
136	BATCH HT. TRT. FURNACES 2-8 & 10	284.700 MCF/HR	Natural Gas
146A	145' NAB FURNACE (CHT)	55.000 MCF/HR	Natural Gas
146B	200' NAB FURNACE (CHT)	128.000 MMBTU/HR	
		128.000 MCF/HR	Natural Gas
151	15 SOAKING PITS	450.000 MCF/HR	Natural Gas
174	GREEN ANNEAL GRIT BLASTER & BAGHOUSE	25.000 Tons/HR	STEEL PLATES
176	VERT. BLAST CONT. FIN. & BAGHOUSE	35.000 Tons/HR	STEEL PLATES
181	SOUTH STEEL YARD & BAGHOUSE	200.000 Tons/HR	STEEL INGOTS
182	ACA POWDER CUTTING & BAGHOUSE	50.000 Tons/HR	STEEL SLABS
183	MISC PROCS & GAS USE (10)	259.000 MCF/HR	Natural Gas
190	BICKLEY FURNACE	6.000 MCF/HR	Natural Gas
192	140M SAUDER FURNACE	8.000 MCF/HR	Natural Gas
207	ICA HOT TOP CUT. STATION & BAGHOUSE	75.000 Tons/HR	INGOTS & SLABS
211	PARTS WASHERS	2,700.000 Lbs/HR	SOLVENT
226	12,000 GAL UNDERGROUND GAS STORAGE TANK	12,000.000 Gal/HR	GASOLINE
228	LADLE REFINER - FCE	177.000 Tons/HR	CARBON/ALLOY/STAINLESS
229	LADLE PRE-HEATER	10.000 MMBTU/HR	
		9.709 MCF/HR	Natural Gas
229A	LADLE PRE-HEATER (4575-10-B)	12.000 MMBTU/HR	
		11.650 MCF/HR	Natural Gas
229B	LADLE PRE-HEATERS "B" AND "D"	24.000 MMBTU/HR	
		23.300 MCF/HR	Natural Gas
230	VACUUM OXYGEN DECARBURIZATION (VOD)	75.000 Tons/HR	LIQUID METAL
		8.400 MCF/HR	Natural Gas
231	EMS LADLE DRYER/PREHEATER	10.000 MCF/HR	Natural Gas
232	SLAG SKIMMING-VOD & BAGHOUSE	75.000 Tons/HR	SLAG
234	TEEMING PROCESS & BAGHOUSE	165.000 Tons/HR	LIQUID STEEL
235	SLAB CUT-OFF TORCH & BAGHOUSE	2.100 MCF/HR	Natural Gas
237	CASTER DECK	271.000 Tons/HR	LADLE
238	MOLD GRINDING & BAGHOUSE	3.100 Lbs/HR	PARTICULATES
249	SURFACE COATING	50.000 Gal/HR	PAINT
250	IDENTIFICATION MARKING	50.000 Gal/HR	PAINT
254	NICKEL PLATING LINE AND 2 SCRUBBERS	20.000 Tons/HR	STEEL PLATES
258	HORIZONTAL GRIT BLASTER AND BAGHOUSE	18.000 Tons/HR	STEEL PLATES

**SECTION A. Site Inventory List**

Source ID	Source Name	Capacity/Throughput	Fuel/Material
270	CONTINUOUS CASTING SPRAY CHAMBER	93.600 Tons/HR	STRAND
768	EMER PUMP/GENERATOR (20 MM GAL RESERVIOR)	25.000 Gal/HR	Diesel Fuel
769	NG EMERG ICU'S	N/A	Natural Gas
770	SMALL EMERGENCY GENERATORS/PUMPS	N/A	NATURAL GAS/PROPANE
		N/A	DIESEL FUEL/GASOLINE
C003	A, B & D BAGHOUSES	72.000 Lbs/HR	PARTICULATES
C012	VERT BLASTER BAGHOUSE	N/A	PARTICULATES
C017	SOUTH STEEL YARD BAGHOUSE	N/A	PARTICULATES
C090	CANOPY SYS. BAGHOUSE "E"	71.300 Lbs/HR	PARTICULATES
C101	ICA HOT TOP CUT STATION BAGHOUSE	N/A	PARTICULATES
C104	VOD FLARE		
C105	CASTER BAGHOUSE	N/A	PARTICULATES
C106	MOLD GRINDING BAGHOUSE	N/A	PARTICULATES
C110	PLATE CLEANING LINE SCRUBBER		
C111	NICKEL PLATING LINE SCRUBBER		
C113	HORIZ GRIT BLSTR BAGHOUSE	N/A	PARTICULATES
C141	CAMFIL-FARR DUST COLLECTOR	N/A	PARTICULATES
C182	GE ENERGY DUST COLLECTOR		
FML01	NATURAL GAS		
FML02	PROPANE		
FML03	DIESEL FUEL		
FML05	GASOLINE		
S03	A B D BAGHOUSE STACK		
S105	HOT TOP BAGHOUSE STACK		
S119	VOD FLARE STACK		
S120	PREHEATER STACK		
S121	EMS BOILER STACK		
S122	C-O TORCH BAGHOUSE STACK		
S140	CASTER SPRAY STACK		
S141	2-ARC BLDG BOILERS STACK		
S145	SOAK PIT 37 STACK		
S146	SOAK PIT 38/39/40 STACK		
S147	SOAK PIT 41/42/43 STACK		
S148	SOAK PIT 44/45/46 STACK		
S149	SOAK PIT 47/48/49 STACK		
S37	SOAK PIT 35 STACK		
S38	SOAK PIT 36 STACK		
S48	GREEN ANNEAL G.B.STACK		
S50	VERT.BLAST CONT.FIN.STK.		
S55	HOT TOP CUTTER BAGHS.STK.		

**SECTION A. Site Inventory List**

Source ID	Source Name	Capacity/Throughput	Fuel/Material
S56	ACA POWDER CUTTING BAGHS.		
S62	EMER PUMP/GEN STACK		
S769	NG EMERG ICU'S STACK		
S770	SMALL EMERGENCY GEN/PUMP STACKS		
S80	NI PLATE SCRUBBER STACK		
S81	NI PLATE SCRUBBER STACK		
S83	HORIZ GRIT BLSTR STACK		
S90	CANOPY STACK (EMS)		
Z03	EMS FUGITIVES		
Z10	BATCH HT.FURNACE EMISSION		
Z100	MISC. FUGITIVES		
Z101	GRIT BLAST FUGITIVES		
Z12	NAB FURNACE FUGITIVES		
Z13	SAFETY KLEEN EMISSIONS		
Z16	FUEL STORAGE FUGITIVES		
Z21	ROLLING MILL FUGITIVES		
Z24	CUT-OFF TORCH FUGITIVES		
Z54	SURFACE COATING FUGITIVES		
Z55	ID MARKING FUGITIVES		

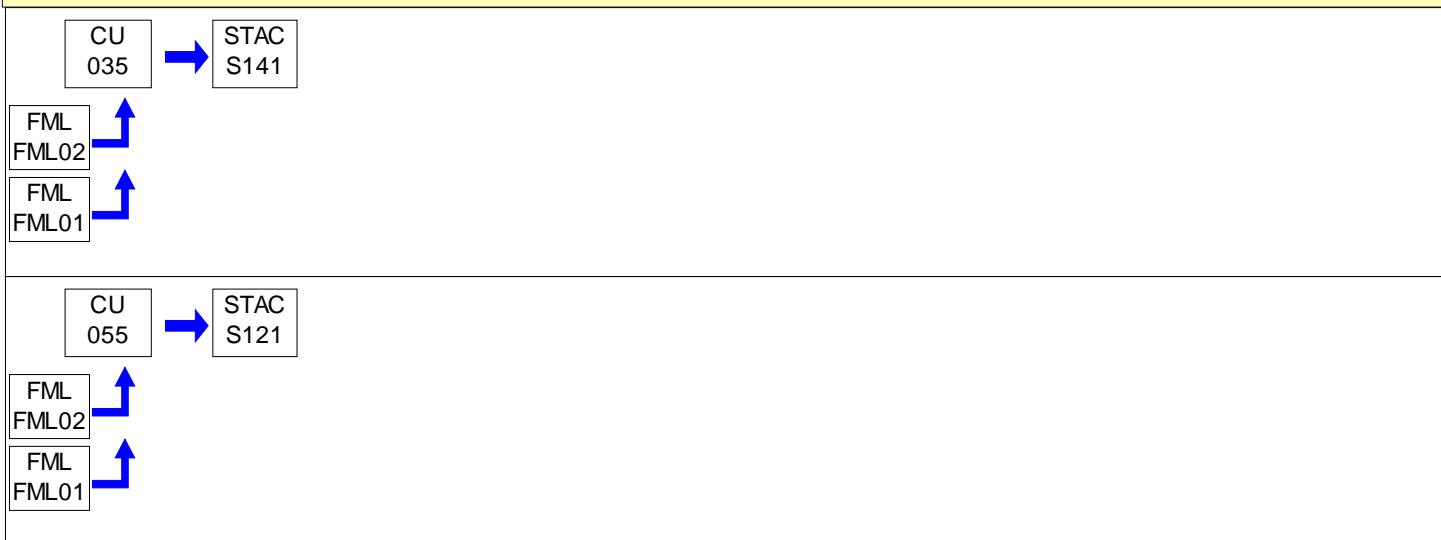
PERMIT MAPS



PERMIT MAPS

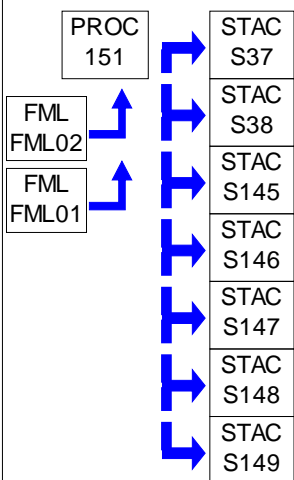
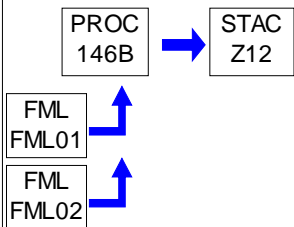
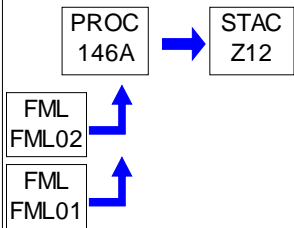
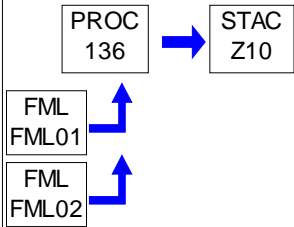
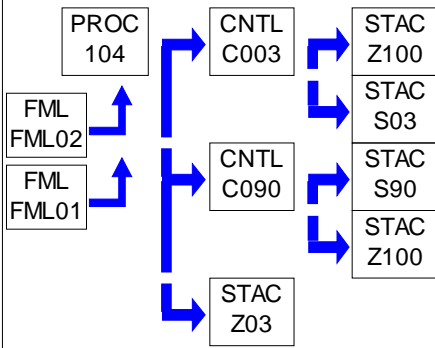



PERMIT MAPS

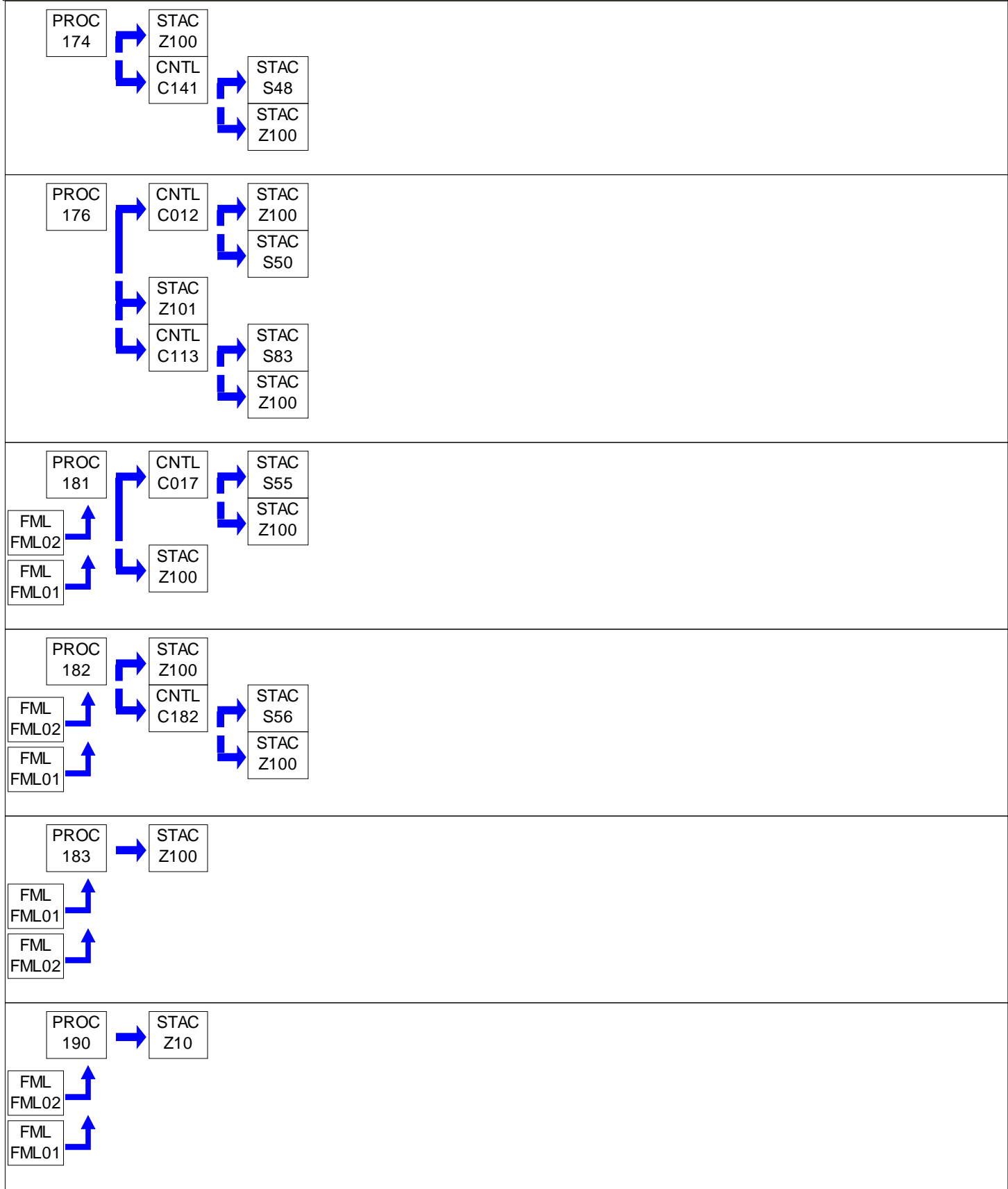



PERMIT MAPS

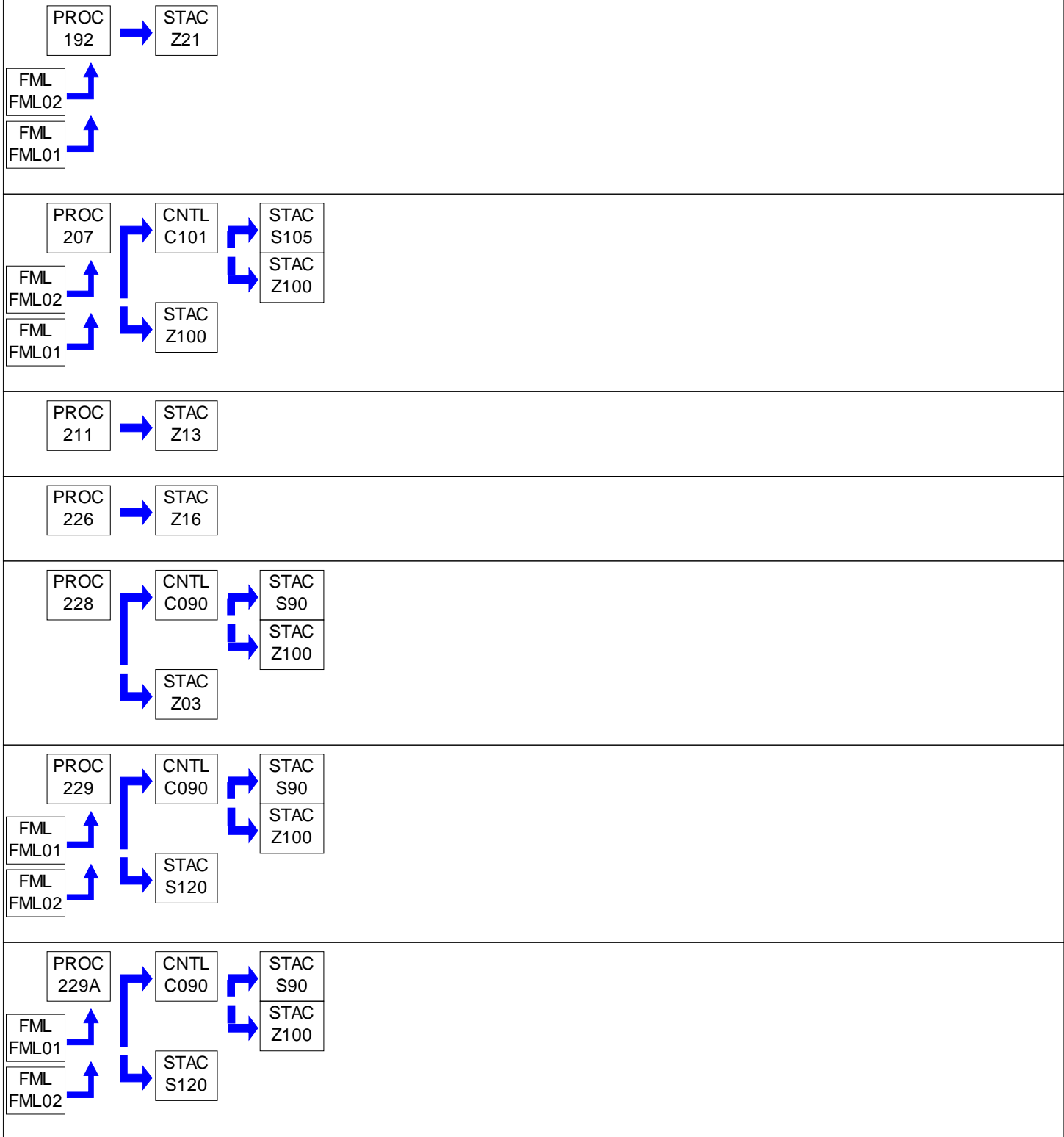



PERMIT MAPS

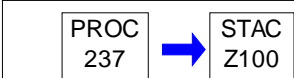
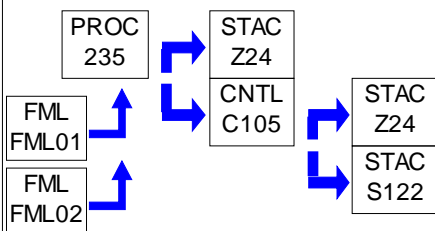
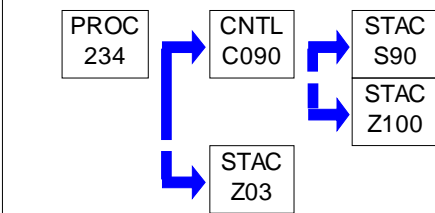
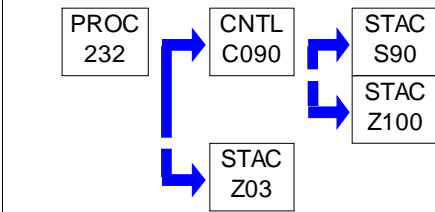
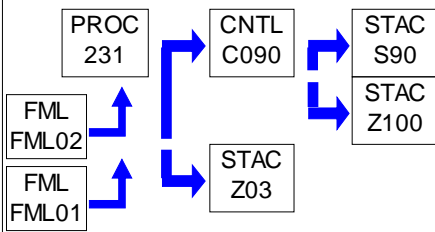
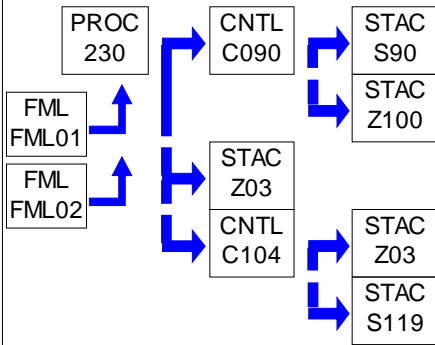
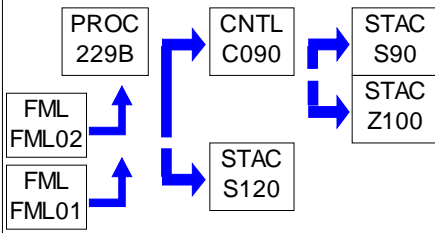



PERMIT MAPS

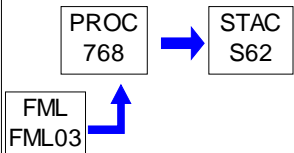
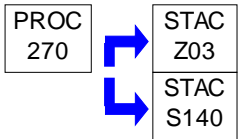
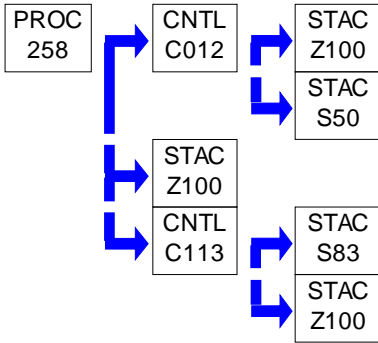
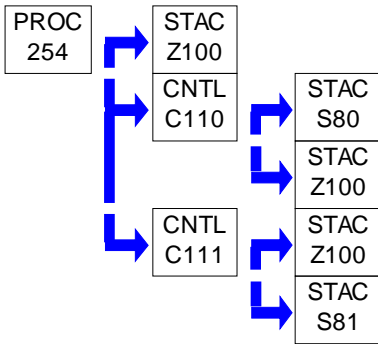
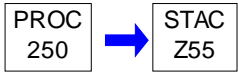
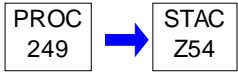
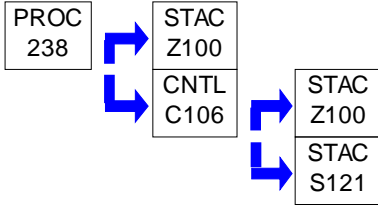



PERMIT MAPS

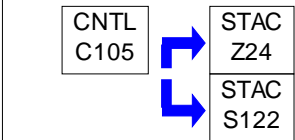
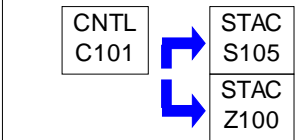
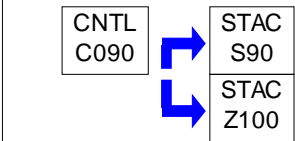
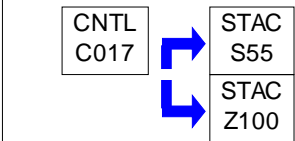
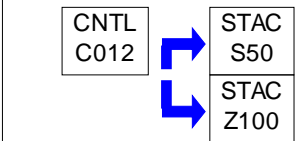
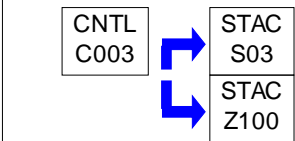
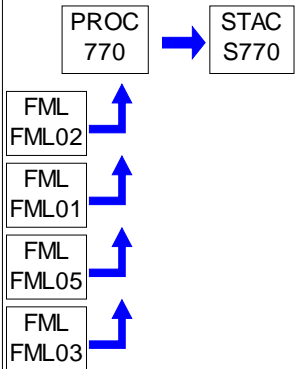
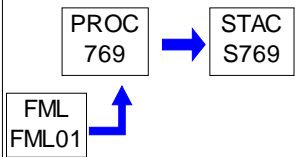



PERMIT MAPS

CNTL
C106 → STAC
Z100

CNTL
C113 ↻ STAC
Z100
STAC
S83

CNTL
C141 ↻ STAC
S48
STAC
Z100

CNTL
C182 ↻ STAC
S56
STAC
Z100

**SECTION B. General Title V Requirements****#001 [25 Pa. Code § 121.1]****Definitions**

Words and terms that are not otherwise defined in this permit shall have the meanings set forth in Section 3 of the Air Pollution Control Act (35 P.S. § 4003) and 25 Pa. Code § 121.1.

#002 [25 Pa. Code § 121.7]**Prohibition of Air Pollution**

No person may permit air pollution as that term is defined in the act.

#003 [25 Pa. Code § 127.512(c)(4)]**Property Rights**

This permit does not convey property rights of any sort, or any exclusive privileges.

#004 [25 Pa. Code § 127.446(a) and (c)]**Permit Expiration**

This operating permit is issued for a fixed term of five (5) years and shall expire on the date specified on Page 1 of this permit. The terms and conditions of the expired permit shall automatically continue pending issuance of a new Title V permit, provided the permittee has submitted a timely and complete application and paid applicable fees required under 25 Pa. Code Chapter 127, Subchapter I and the Department is unable, through no fault of the permittee, to issue or deny a new permit before the expiration of the previous permit. An application is complete if it contains sufficient information to begin processing the application, has the applicable sections completed and has been signed by a responsible official.

#005 [25 Pa. Code §§ 127.412, 127.413, 127.414, 127.446(e) & 127.503]**Permit Renewal**

(a) An application for the renewal of the Title V permit shall be submitted to the Department at least six (6) months, and not more than 18 months, before the expiration date of this permit. The renewal application is timely if a complete application is submitted to the Department's Regional Air Manager within the timeframe specified in this permit condition.

(b) The application for permit renewal shall include the current permit number, the appropriate permit renewal fee, a description of any permit revisions and off-permit changes that occurred during the permit term, and any applicable requirements that were promulgated and not incorporated into the permit during the permit term.

(c) The renewal application shall also include submission of proof that the local municipality and county, in which the facility is located, have been notified in accordance with 25 Pa. Code § 127.413. The application for renewal of the Title V permit shall also include submission of compliance review forms which have been used by the permittee to update information submitted in accordance with either 25 Pa. Code § 127.412(b) or § 127.412(j).

(d) The permittee, upon becoming aware that any relevant facts were omitted or incorrect information was submitted in the permit application, shall promptly submit such supplementary facts or corrected information during the permit renewal process. The permittee shall also promptly provide additional information as necessary to address any requirements that become applicable to the source after the date a complete renewal application was submitted but prior to release of a draft permit.

#006 [25 Pa. Code §§ 127.450(a)(4) & 127.464(a)]**Transfer of Ownership or Operational Control**

(a) In accordance with 25 Pa. Code § 127.450(a)(4), a change in ownership or operational control of the source shall be treated as an administrative amendment if:

(1) The Department determines that no other change in the permit is necessary;

(2) A written agreement has been submitted to the Department identifying the specific date of the transfer of permit responsibility, coverage and liability between the current and the new permittee; and,

(3) A compliance review form has been submitted to the Department and the permit transfer has been approved by the Department.

**SECTION B. General Title V Requirements**

(b) In accordance with 25 Pa. Code § 127.464(a), this permit may not be transferred to another person except in cases of transfer-of-ownership which are documented and approved to the satisfaction of the Department.

#007 [25 Pa. Code § 127.513, 35 P.S. § 4008 and § 114 of the CAA]**Inspection and Entry**

(a) Upon presentation of credentials and other documents as may be required by law for inspection and entry purposes, the permittee shall allow the Department of Environmental Protection or authorized representatives of the Department to perform the following:

- (1) Enter at reasonable times upon the permittee's premises where a Title V source is located or emissions related activity is conducted, or where records are kept under the conditions of this permit;
- (2) Have access to and copy or remove, at reasonable times, records that are kept under the conditions of this permit;
- (3) Inspect at reasonable times, facilities, equipment including monitoring and air pollution control equipment, practices, or operations regulated or required under this permit;
- (4) Sample or monitor, at reasonable times, substances or parameters, for the purpose of assuring compliance with the permit or applicable requirements as authorized by the Clean Air Act, the Air Pollution Control Act, or the regulations promulgated under the Acts.

(b) Pursuant to 35 P.S. § 4008, no person shall hinder, obstruct, prevent or interfere with the Department or its personnel in the performance of any duty authorized under the Air Pollution Control Act.

(c) Nothing in this permit condition shall limit the ability of the EPA to inspect or enter the premises of the permittee in accordance with Section 114 or other applicable provisions of the Clean Air Act.

#008 [25 Pa. Code §§ 127.25, 127.444, & 127.512(c)(1)]**Compliance Requirements**

(a) The permittee shall comply with the conditions of this permit. Noncompliance with this permit constitutes a violation of the Clean Air Act and the Air Pollution Control Act and is grounds for one (1) or more of the following:

- (1) Enforcement action
- (2) Permit termination, revocation and reissuance or modification
- (3) Denial of a permit renewal application

(b) A person may not cause or permit the operation of a source, which is subject to 25 Pa. Code Article III, unless the source(s) and air cleaning devices identified in the application for the plan approval and operating permit and the plan approval issued to the source are operated and maintained in accordance with specifications in the applications and the conditions in the plan approval and operating permit issued by the Department. A person may not cause or permit the operation of an air contamination source subject to 25 Pa. Code Chapter 127 in a manner inconsistent with good operating practices.

(c) For purposes of Sub-condition (b) of this permit condition, the specifications in applications for plan approvals and operating permits are the physical configurations and engineering design details which the Department determines are essential for the permittee's compliance with the applicable requirements in this Title V permit.

#009 [25 Pa. Code § 127.512(c)(2)]**Need to Halt or Reduce Activity Not a Defense**

It shall not be a defense for a permittee in an enforcement action that it would have been necessary to halt or reduce the permitted activity in order to maintain compliance with the conditions of this permit.

#010 [25 Pa. Code §§ 127.411(d) & 127.512(c)(5)]**Duty to Provide Information**

(a) The permittee shall furnish to the Department, within a reasonable time, information that the Department may request in writing to determine whether cause exists for modifying, revoking and reissuing, or terminating the permit, or

**SECTION B. General Title V Requirements**

to determine compliance with the permit.

(b) Upon request, the permittee shall also furnish to the Department copies of records that the permittee is required to keep by this permit, or for information claimed to be confidential, the permittee may furnish such records directly to the Administrator of EPA along with a claim of confidentiality.

#011 [25 Pa. Code §§ 127.463, 127.512(c)(3) & 127.542]**Reopening and Revising the Title V Permit for Cause**

(a) This Title V permit may be modified, revoked, reopened and reissued or terminated for cause. The filing of a request by the permittee for a permit modification, revocation and reissuance, or termination, or of a notification of planned changes or anticipated noncompliance does not stay a permit condition.

(b) This permit may be reopened, revised and reissued prior to expiration of the permit under one or more of the following circumstances:

(1) Additional applicable requirements under the Clean Air Act or the Air Pollution Control Act become applicable to a Title V facility with a remaining permit term of three (3) or more years prior to the expiration date of this permit. The Department will revise the permit as expeditiously as practicable but not later than 18 months after promulgation of the applicable standards or regulations. No such revision is required if the effective date of the requirement is later than the expiration date of this permit, unless the original permit or its terms and conditions has been extended.

(2) Additional requirements, including excess emissions requirements, become applicable to an affected source under the acid rain program. Upon approval by the Administrator of EPA, excess emissions offset plans for an affected source shall be incorporated into the permit.

(3) The Department or the EPA determines that this permit contains a material mistake or inaccurate statements were made in establishing the emissions standards or other terms or conditions of this permit.

(4) The Department or the Administrator of EPA determines that the permit must be revised or revoked to assure compliance with the applicable requirements.

(c) Proceedings to revise this permit shall follow the same procedures which apply to initial permit issuance and shall affect only those parts of this permit for which cause to revise exists. The revision shall be made as expeditiously as practicable.

(d) Regardless of whether a revision is made in accordance with (b)(1) above, the permittee shall meet the applicable standards or regulations promulgated under the Clean Air Act within the time frame required by standards or regulations.

#012 [25 Pa. Code § 127.543]**Reopening a Title V Permit for Cause by EPA**

As required by the Clean Air Act and regulations adopted thereunder, this permit may be modified, reopened and reissued, revoked or terminated for cause by EPA in accordance with procedures specified in 25 Pa. Code § 127.543.

#013 [25 Pa. Code § 127.522(a)]**Operating Permit Application Review by the EPA**

The applicant may be required by the Department to provide a copy of the permit application, including the compliance plan, directly to the Administrator of the EPA. Copies of title V permit applications to EPA, pursuant to 25 PA Code §127.522(a), shall be submitted, if required, to the following EPA e-mail box:

R3_Air_Apps_and_Notices@epa.gov

Please place the following in the subject line: TV [permit number], [Facility Name].

#014 [25 Pa. Code § 127.541]**Significant Operating Permit Modifications**

When permit modifications during the term of this permit do not qualify as minor permit modifications or administrative amendments, the permittee shall submit an application for significant Title V permit modifications in accordance with

**SECTION B. General Title V Requirements**

25 Pa. Code § 127.541. Notifications to EPA, pursuant to 25 PA Code §127.522(a), if required, shall be submitted, to the following EPA e-mail box:

R3_Air_Apps_and_Notices@epa.gov

Please place the following in the subject line: TV [permit number], [Facility Name].

#015 [25 Pa. Code §§ 121.1 & 127.462]**Minor Operating Permit Modifications**

The permittee may make minor operating permit modifications (as defined in 25 Pa. Code §121.1), on an expedited basis, in accordance with 25 Pa. Code §127.462 (relating to minor operating permit modifications). Notifications to EPA, pursuant to 25 PA Code §127.462(c), if required, shall be submitted, to the following EPA e-mail box:

R3_Air_Apps_and_Notices@epa.gov

Please place the following in the subject line: TV [permit number], [Facility Name].

#016 [25 Pa. Code § 127.450]**Administrative Operating Permit Amendments**

(a) The permittee may request administrative operating permit amendments, as defined in 25 Pa. Code §127.450(a). Copies of request for administrative permit amendment to EPA, pursuant to 25 PA Code §127.450(c)(1), if required, shall be submitted to the following EPA e-mail box:

R3_Air_Apps_and_Notices@epa.gov

Please place the following in the subject line: TV [permit number], [Facility Name].

(b) Upon final action by the Department granting a request for an administrative operating permit amendment covered under §127.450(a)(5), the permit shield provisions in 25 Pa. Code § 127.516 (relating to permit shield) shall apply to administrative permit amendments incorporated in this Title V Permit in accordance with §127.450(c), unless precluded by the Clean Air Act or the regulations thereunder.

#017 [25 Pa. Code § 127.512(b)]**Severability Clause**

The provisions of this permit are severable, and if any provision of this permit is determined by the Environmental Hearing Board or a court of competent jurisdiction, or US EPA to be invalid or unenforceable, such a determination will not affect the remaining provisions of this permit.

#018 [25 Pa. Code §§ 127.704, 127.705 & 127.707]**Fee Payment**

(a) The permittee shall pay fees to the Department in accordance with the applicable fee schedules in 25 Pa. Code Chapter 127, Subchapter I (relating to plan approval and operating permit fees).

(b) Emission Fees. The permittee shall, on or before September 1st of each year, pay applicable annual Title V emission fees for emissions occurring in the previous calendar year as specified in 25 Pa. Code § 127.705. The permittee is not required to pay an emission fee for emissions of more than 4,000 tons of each regulated pollutant emitted from the facility.

(c) As used in this permit condition, the term "regulated pollutant" is defined as a VOC, each pollutant regulated under Sections 111 and 112 of the Clean Air Act and each pollutant for which a National Ambient Air Quality Standard has been promulgated, except that carbon monoxide is excluded.

(d) Late Payment. Late payment of emission fees will subject the permittee to the penalties prescribed in 25 Pa. Code § 127.707 and may result in the suspension or termination of the Title V permit. The permittee shall pay a penalty of fifty percent (50%) of the fee amount, plus interest on the fee amount computed in accordance with 26 U.S.C.A. § 6621(a)(2) from the date the emission fee should have been paid in accordance with the time frame specified in 25 Pa. Code § 127.705(c).

**SECTION B. General Title V Requirements**

(e) The permittee shall pay an annual operating permit administration fee according to the fee schedule established in 25 Pa. Code § 127.704(c) if the facility, identified in Subparagraph (iv) of the definition of the term "Title V facility" in 25 Pa. Code § 121.1, is subject to Title V after the EPA Administrator completes a rulemaking requiring regulation of those sources under Title V of the Clean Air Act.

(f) This permit condition does not apply to a Title V facility which qualifies for exemption from emission fees under 35 P.S. § 4006.3(f).

#019 [25 Pa. Code §§ 127.14(b) & 127.449]**Authorization for De Minimis Emission Increases**

(a) This permit authorizes de minimis emission increases from a new or existing source in accordance with 25 Pa. Code §§ 127.14 and 127.449 without the need for a plan approval or prior issuance of a permit modification. The permittee shall provide the Department with seven (7) days prior written notice before commencing any de minimis emissions increase that would result from either: (1) a physical change of minor significance under § 127.14(c)(1); or (2) the construction, installation, modification or reactivation of an air contamination source. The written notice shall:

- (1) Identify and describe the pollutants that will be emitted as a result of the de minimis emissions increase.
- (2) Provide emission rates expressed in tons per year and in terms necessary to establish compliance consistent with any applicable requirement.

The Department may disapprove or condition de minimis emission increases at any time.

(b) Except as provided below in (c) and (d) of this permit condition, the permittee is authorized during the term of this permit to make de minimis emission increases (expressed in tons per year) up to the following amounts without the need for a plan approval or prior issuance of a permit modification:

- (1) Four tons of carbon monoxide from a single source during the term of the permit and 20 tons of carbon monoxide at the facility during the term of the permit.
- (2) One ton of NO_x from a single source during the term of the permit and 5 tons of NO_x at the facility during the term of the permit.
- (3) One and six-tenths tons of the oxides of sulfur from a single source during the term of the permit and 8.0 tons of oxides of sulfur at the facility during the term of the permit.
- (4) Six-tenths of a ton of PM₁₀ from a single source during the term of the permit and 3.0 tons of PM₁₀ at the facility during the term of the permit. This shall include emissions of a pollutant regulated under Section 112 of the Clean Air Act unless precluded by the Clean Air Act or 25 Pa. Code Article III.
- (5) One ton of VOCs from a single source during the term of the permit and 5.0 tons of VOCs at the facility during the term of the permit. This shall include emissions of a pollutant regulated under Section 112 of the Clean Air Act unless precluded by the Clean Air Act or 25 Pa. Code Article III.

(c) In accordance with § 127.14, the permittee may install the following minor sources without the need for a plan approval:

- (1) Air conditioning or ventilation systems not designed to remove pollutants generated or released from other sources.
- (2) Combustion units rated at 2,500,000 or less Btu per hour of heat input.
- (3) Combustion units with a rated capacity of less than 10,000,000 Btu per hour heat input fueled by natural gas supplied by a public utility, liquefied petroleum gas or by commercial fuel oils which are No. 2 or lighter, viscosity less than or equal to 5.82 c St, and which meet the sulfur content requirements of 25 Pa. Code § 123.22 (relating to combustion units). For purposes of this permit, commercial fuel oil shall be virgin oil which has no reprocessed, recycled or waste material added.
- (4) Space heaters which heat by direct heat transfer.

**SECTION B. General Title V Requirements**

(5) Laboratory equipment used exclusively for chemical or physical analysis.

(6) Other sources and classes of sources determined to be of minor significance by the Department.

(d) This permit does not authorize de minimis emission increases if the emissions increase would cause one or more of the following:

(1) Increase the emissions of a pollutant regulated under Section 112 of the Clean Air Act except as authorized in Subparagraphs (b)(4) and (5) of this permit condition.

(2) Subject the facility to the prevention of significant deterioration requirements in 25 Pa. Code Chapter 127, Subchapter D and/or the new source review requirements in Subchapter E.

(3) Violate any applicable requirement of the Air Pollution Control Act, the Clean Air Act, or the regulations promulgated under either of the acts.

(4) Changes which are modifications under any provision of Title I of the Clean Air Act and emission increases which would exceed the allowable emissions level (expressed as a rate of emissions or in terms of total emissions) under the Title V permit.

(e) Unless precluded by the Clean Air Act or the regulations thereunder, the permit shield described in 25 Pa. Code § 127.516 (relating to permit shield) shall extend to the changes made under 25 Pa. Code § 127.449 (relating to de minimis emission increases).

(f) Emissions authorized under this permit condition shall be included in the monitoring, recordkeeping and reporting requirements of this permit.

(g) Except for de minimis emission increases allowed under this permit, 25 Pa. Code § 127.449, or sources and physical changes meeting the requirements of 25 Pa. Code § 127.14, the permittee is prohibited from making physical changes or engaging in activities that are not specifically authorized under this permit without first applying for a plan approval. In accordance with § 127.14(b), a plan approval is not required for the construction, modification, reactivation, or installation of the sources creating the de minimis emissions increase.

(h) The permittee may not meet de minimis emission threshold levels by offsetting emission increases or decreases at the same source.

#020 [25 Pa. Code §§ 127.11a & 127.215]**Reactivation of Sources**

(a) The permittee may reactivate a source at the facility that has been out of operation or production for at least one year, but less than or equal to five (5) years, if the source is reactivated in accordance with the requirements of 25 Pa. Code §§ 127.11a and 127.215. The reactivated source will not be considered a new source.

(b) A source which has been out of operation or production for more than five (5) years but less than 10 years may be reactivated and will not be considered a new source if the permittee satisfies the conditions specified in 25 Pa. Code § 127.11a(b).

#021 [25 Pa. Code §§ 121.9 & 127.216]**Circumvention**

(a) The owner of this Title V facility, or any other person, may not circumvent the new source review requirements of 25 Pa. Code Chapter 127, Subchapter E by causing or allowing a pattern of ownership or development, including the phasing, staging, delaying or engaging in incremental construction, over a geographic area of a facility which, except for the pattern of ownership or development, would otherwise require a permit or submission of a plan approval application.

(b) No person may permit the use of a device, stack height which exceeds good engineering practice stack height, dispersion technique or other technique which, without resulting in reduction of the total amount of air contaminants emitted, conceals or dilutes an emission of air contaminants which would otherwise be in violation of this permit, the Air Pollution Control Act or the regulations promulgated thereunder, except that with prior approval of the Department,

**SECTION B. General Title V Requirements**

the device or technique may be used for control of malodors.

#022 [25 Pa. Code §§ 127.402(d) & 127.513(1)]**Submissions**

(a) Reports, test data, monitoring data, notifications and requests for renewal of the permit shall be submitted to the:

Regional Air Program Manager
PA Department of Environmental Protection
(At the address given on the permit transmittal letter,
or otherwise notified)

(b) Any report or notification for the EPA Administrator or EPA Region III should be addressed to:

Office of Air Enforcement and Compliance Assistance (3AP20)
United States Environmental Protection Agency
Region 3
1650 Arch Street
Philadelphia, PA 19103-2029

(c) An application, form, report or compliance certification submitted pursuant to this permit condition shall contain certification by a responsible official as to truth, accuracy, and completeness as required under 25 Pa. Code § 127.402(d). Unless otherwise required by the Clean Air Act or regulations adopted thereunder, this certification and any other certification required pursuant to this permit shall state that, based on information and belief formed after reasonable inquiry, the statements and information in the document are true, accurate and complete.

#023 [25 Pa. Code §§ 127.441(c) & 127.463(e); Chapter 139; & 114(a)(3), 504(b) of the CAA]**Sampling, Testing and Monitoring Procedures**

(a) The permittee shall perform the emissions monitoring and analysis procedures or test methods for applicable requirements of this Title V permit. In addition to the sampling, testing and monitoring procedures specified in this permit, the Permittee shall comply with any additional applicable requirements promulgated under the Clean Air Act after permit issuance regardless of whether the permit is revised.

(b) The sampling, testing and monitoring required under the applicable requirements of this permit, shall be conducted in accordance with the requirements of 25 Pa. Code Chapter 139 unless alternative methodology is required by the Clean Air Act (including §§ 114(a)(3) and 504(b)) and regulations adopted thereunder.

#024 [25 Pa. Code §§ 127.511 & Chapter 135]**Recordkeeping Requirements**

(a) The permittee shall maintain and make available, upon request by the Department, records of required monitoring information that include the following:

- (1) The date, place (as defined in the permit) and time of sampling or measurements.
- (2) The dates the analyses were performed.
- (3) The company or entity that performed the analyses.
- (4) The analytical techniques or methods used.
- (5) The results of the analyses.
- (6) The operating conditions as existing at the time of sampling or measurement.

(b) The permittee shall retain records of the required monitoring data and supporting information for at least five (5) years from the date of the monitoring sample, measurement, report or application. Supporting information includes the calibration data and maintenance records and original strip-chart recordings for continuous monitoring instrumentation, and copies of reports required by the permit.

**SECTION B. General Title V Requirements**

(c) The permittee shall maintain and make available to the Department upon request, records including computerized records that may be necessary to comply with the reporting, recordkeeping and emission statement requirements in 25 Pa. Code Chapter 135 (relating to reporting of sources). In accordance with 25 Pa. Code Chapter 135, § 135.5, such records may include records of production, fuel usage, maintenance of production or pollution control equipment or other information determined by the Department to be necessary for identification and quantification of potential and actual air contaminant emissions. If direct recordkeeping is not possible or practical, sufficient records shall be kept to provide the needed information by indirect means.

#025 [25 Pa. Code §§ 127.411(d), 127.442, 127.463(e) & 127.511(c)]**Reporting Requirements**

(a) The permittee shall comply with the reporting requirements for the applicable requirements specified in this Title V permit. In addition to the reporting requirements specified herein, the permittee shall comply with any additional applicable reporting requirements promulgated under the Clean Air Act after permit issuance regardless of whether the permit is revised.

(b) Pursuant to 25 Pa. Code § 127.511(c), the permittee shall submit reports of required monitoring at least every six (6) months unless otherwise specified in this permit. Instances of deviations (as defined in 25 Pa. Code § 121.1) from permit requirements shall be clearly identified in the reports. The reporting of deviations shall include the probable cause of the deviations and corrective actions or preventative measures taken, except that sources with continuous emission monitoring systems shall report according to the protocol established and approved by the Department for the source. The required reports shall be certified by a responsible official.

(c) Every report submitted to the Department under this permit condition shall comply with the submission procedures specified in Section B, Condition #022(c) of this permit.

(d) Any records, reports or information obtained by the Department or referred to in a public hearing shall be made available to the public by the Department except for such records, reports or information for which the permittee has shown cause that the documents should be considered confidential and protected from disclosure to the public under Section 4013.2 of the Air Pollution Control Act and consistent with Sections 112(d) and 114(c) of the Clean Air Act and 25 Pa. Code § 127.411(d). The permittee may not request a claim of confidentiality for any emissions data generated for the Title V facility.

#026 [25 Pa. Code § 127.513]**Compliance Certification**

(a) One year after the date of issuance of the Title V permit, and each year thereafter, unless specified elsewhere in the permit, the permittee shall submit to the Department and EPA Region III a certificate of compliance with the terms and conditions in this permit, for the previous year, including the emission limitations, standards or work practices. This certification shall include:

- (1) The identification of each term or condition of the permit that is the basis of the certification.
- (2) The compliance status.
- (3) The methods used for determining the compliance status of the source, currently and over the reporting period.
- (4) Whether compliance was continuous or intermittent.

(b) The compliance certification shall be postmarked or hand-delivered no later than thirty days after each anniversary of the date of issuance of this Title V Operating Permit, or on the submittal date specified elsewhere in the permit, to the Department and EPA in accordance with the submission requirements specified in condition #022 of this section.

#027 [25 Pa. Code § 127.3]**Operational Flexibility**

The permittee is authorized to make changes within the Title V facility in accordance with the following provisions in 25 Pa. Code Chapter 127 which implement the operational flexibility requirements of Section 502(b)(10) of the Clean Air Act and Section 6.1(i) of the Air Pollution Control Act:

- (1) Section 127.14 (relating to exemptions)

**SECTION B. General Title V Requirements**

- (2) Section 127.447 (relating to alternative operating scenarios)
- (3) Section 127.448 (relating to emissions trading at facilities with federally enforceable emissions caps)
- (4) Section 127.449 (relating to de minimis emission increases)
- (5) Section 127.450 (relating to administrative operating permit amendments)
- (6) Section 127.462 (relating to minor operating permit amendments)
- (7) Subchapter H (relating to general plan approvals and operating permits)

#028 [25 Pa. Code §§ 127.441(d), 127.512(i) and 40 CFR Part 68]**Risk Management**

(a) If required by Section 112(r) of the Clean Air Act, the permittee shall develop and implement an accidental release program consistent with requirements of the Clean Air Act, 40 CFR Part 68 (relating to chemical accident prevention provisions) and the Federal Chemical Safety Information, Site Security and Fuels Regulatory Relief Act (P.L. 106-40).

(b) The permittee shall prepare and implement a Risk Management Plan (RMP) which meets the requirements of Section 112(r) of the Clean Air Act, 40 CFR Part 68 and the Federal Chemical Safety Information, Site Security and Fuels Regulatory Relief Act when a regulated substance listed in 40 CFR § 68.130 is present in a process in more than the listed threshold quantity at the Title V facility. The permittee shall submit the RMP to the federal Environmental Protection Agency according to the following schedule and requirements:

(1) The permittee shall submit the first RMP to a central point specified by EPA no later than the latest of the following:

- (i) Three years after the date on which a regulated substance is first listed under § 68.130; or,
- (ii) The date on which a regulated substance is first present above a threshold quantity in a process.

(2) The permittee shall submit any additional relevant information requested by the Department or EPA concerning the RMP and shall make subsequent submissions of RMPs in accordance with 40 CFR § 68.190.

(3) The permittee shall certify that the RMP is accurate and complete in accordance with the requirements of 40 CFR Part 68, including a checklist addressing the required elements of a complete RMP.

(c) As used in this permit condition, the term "process" shall be as defined in 40 CFR § 68.3. The term "process" means any activity involving a regulated substance including any use, storage, manufacturing, handling, or on-site movement of such substances or any combination of these activities. For purposes of this definition, any group of vessels that are interconnected, or separate vessels that are located such that a regulated substance could be involved in a potential release, shall be considered a single process.

(d) If the Title V facility is subject to 40 CFR Part 68, as part of the certification required under this permit, the permittee shall:

(1) Submit a compliance schedule for satisfying the requirements of 40 CFR Part 68 by the date specified in 40 CFR § 68.10(a); or,

(2) Certify that the Title V facility is in compliance with all requirements of 40 CFR Part 68 including the registration and submission of the RMP.

(e) If the Title V facility is subject to 40 CFR Part 68, the permittee shall maintain records supporting the implementation of an accidental release program for five (5) years in accordance with 40 CFR § 68.200.

(f) When the Title V facility is subject to the accidental release program requirements of Section 112(r) of the Clean Air Act and 40 CFR Part 68, appropriate enforcement action will be taken by the Department if:

- (1) The permittee fails to register and submit the RMP or a revised plan pursuant to 40 CFR Part 68.

**SECTION B. General Title V Requirements**

(2) The permittee fails to submit a compliance schedule or include a statement in the compliance certification required under Condition #26 of Section B of this Title V permit that the Title V facility is in compliance with the requirements of Section 112(r) of the Clean Air Act, 40 CFR Part 68, and 25 Pa. Code § 127.512(i).

#029 [25 Pa. Code § 127.512(e)]**Approved Economic Incentives and Emission Trading Programs**

No permit revision shall be required under approved economic incentives, marketable permits, emissions trading and other similar programs or processes for changes that are provided for in this Title V permit.

#030 [25 Pa. Code §§ 127.516, 127.450(d), 127.449(f) & 127.462(g)]**Permit Shield**

(a) The permittee's compliance with the conditions of this permit shall be deemed in compliance with applicable requirements (as defined in 25 Pa. Code § 121.1) as of the date of permit issuance if either of the following applies:

- (1) The applicable requirements are included and are specifically identified in this permit.
- (2) The Department specifically identifies in the permit other requirements that are not applicable to the permitted facility or source.

(b) Nothing in 25 Pa. Code § 127.516 or the Title V permit shall alter or affect the following:

- (1) The provisions of Section 303 of the Clean Air Act, including the authority of the Administrator of the EPA provided thereunder.
- (2) The liability of the permittee for a violation of an applicable requirement prior to the time of permit issuance.
- (3) The applicable requirements of the acid rain program, consistent with Section 408(a) of the Clean Air Act.
- (4) The ability of the EPA to obtain information from the permittee under Section 114 of the Clean Air Act.

(c) Unless precluded by the Clean Air Act or regulations thereunder, final action by the Department incorporating a significant permit modification in this Title V Permit shall be covered by the permit shield at the time that the permit containing the significant modification is issued.

#031 [25 Pa. Code §135.3]**Reporting**

(a) The permittee shall submit by March 1 of each year an annual emissions report for the preceding calendar year. The report shall include information for all active previously reported sources, new sources which were first operated during the preceding calendar year, and sources modified during the same period which were not previously reported. All air emissions from the facility should be estimated and reported.

(b) A source owner or operator may request an extension of time from the Department for the filing of an annual emissions report, and the Department may grant the extension for reasonable cause.

#032 [25 Pa. Code §135.4]**Report Format**

Emissions reports shall contain sufficient information to enable the Department to complete its emission inventory. Emissions reports shall be made by the source owner or operator in a format specified by the Department.

**SECTION C. Site Level Requirements****I. RESTRICTIONS.****Emission Restriction(s).****# 001 [25 Pa. Code §121.7]****Prohibition of air pollution.**

No person may permit air pollution as that term is defined in the Air Pollution Control Act (35 P.S. Section 4003).

002 [25 Pa. Code §123.1]**Prohibition of certain fugitive emissions**

No person may permit the emission into the outdoor atmosphere of a fugitive air contaminant from a source other than the following:

- (a) Construction or demolition of buildings or structures.
- (b) Grading, paving and maintenance of roads and streets.
- (c) Use of roads and streets. Emissions from material in or on trucks, railroad cars and other vehicular equipment are not considered as emissions from use of roads and streets.
- (d) Clearing of land.
- (e) Stockpiling of materials.
- (f) Open burning operations, as specified in 25 Pa. Code § 129.14.
- (g) Blasting in open pit mines. Emissions from drilling are not considered as emissions from blasting.
- (h) Coke oven batteries, provided the fugitive air contaminants emitted from any coke oven battery comply with the standards for visible fugitive emissions in 25 Pa. Code §§ 123.44 and 129.15 (relating to limitations of visible fugitive air contaminants from operation of any coke oven battery; and coke pushing operations).
- (i) Sources and classes of sources other than those identified in (a) - (h) above, for which the operator has obtained a determination from the Department, in accordance with 25 Pa. Code § 123.1 (b), that fugitive emissions from the source, after appropriate control, meet the following requirements:
 - (1) The emissions are of minor significance with respect to causing air pollution; and
 - (2) The emissions are not preventing or interfering with the attainment or maintenance of any ambient air quality standard.

003 [25 Pa. Code §123.2]**Fugitive particulate matter**

The permittee may not permit fugitive particulate matter to be emitted into the outdoor atmosphere from a source specified in 25 Pa. Code § 123.1(a) (relating to prohibition of certain fugitive emissions) if such emissions are visible at the point the emissions pass outside the property on which the source(s) are located.

004 [25 Pa. Code §123.31]**Limitations**

The permittee may not permit the emission into the outdoor atmosphere of any malodorous air contaminants from any source, in such a manner that the malodors are detectable outside the property of the person on which the source is being operated.

005 [25 Pa. Code §123.41]**Limitations**

The permittee may not permit the emission into the outdoor atmosphere of visible air contaminants from any source in such a manner that the opacity of the emission is either of the following:

- (a) Equal to or greater than 20% for a period or periods aggregating more than three (3) minutes in any one (1) hour.
- (b) Equal to or greater than 60% at any time.

**SECTION C. Site Level Requirements****# 006 [25 Pa. Code §123.42]****Exceptions**

The limitations of 25 Pa. Code § 123.41 (relating to limitations) shall not apply to a visible emission in any of the following instances:

- (a) When the presence of uncombined water is the only reason for failure of the emission to meet the limitations.
- (b) When the emission results from the operation of equipment used solely to train and test persons in observing the opacity of visible emissions.
- (c) When the emission results from sources specified in 25 Pa. Code § 123.1(a)(1) - (6) (relating to prohibition of certain fugitive emissions).

II. TESTING REQUIREMENTS.**# 007 [25 Pa. Code §127.441]****Operating permit terms and conditions.**

- (a) If at any time the Department has cause to believe that air contaminant emissions from any source(s) listed in Section A, of this Permit, may be in excess of the limitations specified in this Permit, or established pursuant to, any applicable rule or regulation contained in 25 Pa. Code Article III, the permittee shall be required to conduct whatever tests are deemed necessary by the Department to determine the actual emission rate(s).
- (b) Such testing shall be conducted in accordance with the provisions of 25 Pa. Code Chapter 139, when applicable, and in accordance with any restrictions or limitations established by the Department at such time as it notifies the permittee that testing is required.

008 [25 Pa. Code §127.441]**Operating permit terms and conditions.**

The following applies whenever the permittee is required to submit stack test protocols, stack test reports, notifications pertaining to such stack testing, or any other related documents:

- (a) The permittee shall submit one paper copy plus one electronic copy of all source test submissions (notifications, protocols, reports, supplemental information, etc.) to both the AQ Program Manager for the Southeast Regional Office and the PSIMS Administrator in Central Office (mail and email addresses are provided below). Any questions or concerns about source testing submissions can be sent to RA-EPstacktesting@pa.gov and the PSIMS Administrator will address them.
- (b) The following pertinent information shall be listed on the title page.
 - (1) Test Date(s)
 - (i) For protocols, provide the proposed date on which testing will commence or "TBD"
 - (ii) For reports, provide the first and last day of testing
 - (2) Facility Identification Number (Facility - ID): For test programs that were conducted under a multi-site protocol, also include the PF Id under which the protocol was stored in PSIMS, as indicated in the protocol response letter.
 - (3) Source ID(s) for the applicable source(s) and air pollution control device(s): The term Source ID is used in the permit but "Other Id" is used in DEP electronic systems. They are the same number and must also be listed for control equipment.
 - (4) Testing Requirements (all that apply)
 - (i) Plan approval number(s)
 - (ii) Operating permit number
 - (iii) Applicable federal subpart(s) (i.e. 40 CFR 60, Subpart JJJJ)
 - (iv) Special purpose(s) (Consent Order, RFD, RACT II, Tier II, etc.)

**SECTION C. Site Level Requirements**

(c) Mail all paper submissions to both the PSIMS Administrator and the Air Quality Program Manager for the Southeast Regional Office. Mailing addresses are provided below:

Central Office
 Pennsylvania Department of Environmental Protection
 Attn: PSIMS Administrator
 P.O. Box 8468
 Harrisburg, PA 17105-8468

Southeast Region
 Pennsylvania Department of Environmental Protection
 Attn: Air Quality Program Manager
 2 East Main Street
 Norristown, PA 19401

(d) Eliminate shading, color ink for data emphasis, small font size, and color saturation as the scanning to create an electronic file is done in black and white. Shading and color emphasis do not scan well and make the electronic copies difficult to read.

(e) Email all electronic submissions to both the PSIMS Administrator in Central Office and the Air Quality Program Manager for the Southeast Regional Office. Email addresses are provided below:

Central Office
 RA-EPstacktesting@pa.gov

Southeast Region
 RA-EPSEstacktesting@pa.gov

(f) The Department limits emails to 15 MB and PSIMS has a file size limitation of 100 MB for electronic files. Submit just one electronic file (convert any Microsoft Word or Excel files to an Adobe PDF format and combine them with the report or protocol), unless the submission contains CONFIDENTIAL information.

(g) If confidential information must be submitted, submit both a public copy, which has been redacted, and a confidential copy. The cover page of each submittal should state whether it is a "Public Copy" or "Confidential Copy" and each page of the latter must be marked "CONFIDENTIAL".

III. MONITORING REQUIREMENTS.**# 009 [25 Pa. Code §123.43]****Measuring techniques**

Visible emissions may be measured using either of the following:

- (a) A device approved by the Department and maintained to provide accurate opacity measurements.
- (b) Observers, trained and qualified to measure plume opacity with the naked eye or with the aid of any devices approved by the Department.

010 [25 Pa. Code §127.441]**Operating permit terms and conditions.**

(a) The permittee shall monitor the facility, once per operating day, for the following:

- (1) Odors which may be objectionable (as per 25 Pa. Code § 123.31).
- (2) Visible emissions (as per 25 Pa. Code §§ 123.41 and 123.42).
- (3) Fugitive particulate matter (as per 25 Pa. Code §§ 123.1 and 123.2).

(b) All detectable objectionable odors, that originated on-site and cross the property line, as well as fugitive particulate emissions that originated on-site and cross the property line, and visible emissions that originated on site shall:

**SECTION C. Site Level Requirements**

- (1) Be investigated;
- (2) Be reported to the facility management, or individual(s) designated by the permittee; and
- (3) Be recorded in a permanent log.

(c) After six (6) months of daily monitoring, and upon the permittee's request, the Department will determine the feasibility of decreasing the monitoring frequency to weekly for the next six month period.

(d) After six (6) months of weekly monitoring, and upon the permittee's request, the Department will determine the feasibility of decreasing the frequency of monitoring to monthly.

(e) The Department reserves the right to change the above monitoring requirements at any time, based on but not limited to: the review of the compliance certification, complaints, monitoring results, and/or Department findings.

IV. RECORDKEEPING REQUIREMENTS.**# 011 [25 Pa. Code §127.441]****Operating permit terms and conditions.**

The permittee shall keep on hand (at the facility) and have readily access to, all records pertaining to individual source fuel usage (monthly data) and individual source emission data. These records shall be maintained at the facility for a period of five (5) years from the date of recording.

012 [25 Pa. Code §127.441]**Operating permit terms and conditions.**

The permittee shall maintain a record of all monitoring of fugitive emissions, visible emissions and odors that may be objectionable, including those that deviate from the conditions found in this permit. The record of deviations shall contain, at a minimum, the following items:

- (a) Date, time, and location of the incident(s).
- (b) The cause of the incident.
- (c) The corrective action taken, if necessary, to abate the incident and prevent future incidents.

013 [25 Pa. Code §127.441]**Operating permit terms and conditions.**

The permittee shall maintain records of asbestos disposal as required by 40 CFR 61 §§ 145, 150 and 153, Subpart M (National Emission Standards for Asbestos).

014 [25 Pa. Code §129.100]**Compliance demonstration and recordkeeping requirements.**

The owner and operator of an air contamination source subject to 25 Pa. Code § 129.100 and the requirements of 25 Pa. Code §§ 129.96—129.99 shall keep records to demonstrate compliance with 25 Pa. Code §§ 129.96—129.99 in the following manner:

- (a) The records must include sufficient data and calculations to demonstrate that the requirements of 25 Pa. Code §§ 129.96—129.99 are met.
- (b) Data or information required to determine compliance shall be recorded and maintained in a time frame consistent with the averaging period of the requirement.
- (c) The records shall be retained by the permittee for five (5) years and made available to the Department upon receipt of a written request from the Department.

V. REPORTING REQUIREMENTS.**# 015 [25 Pa. Code §127.441]****Operating permit terms and conditions.**

(a) The permittee shall, within twenty-four (24) hours of discovery of any occurrence, notify the Department, at (484) 250-5920, of any malfunction of the source(s) or associated air pollution control devices listed in Section A, of this permit, which results in, or may possibly result in, the emission of air contaminants in excess of the limitations specified in this permit, or

**SECTION C. Site Level Requirements**

of a regulation contained in 25 Pa. Code Article III.

(b) Malfunction(s) which occur at this facility, and pose(s) an imminent danger to public health, safety, welfare and the environment, and would violate permit conditions if the source were to continue to operate after the malfunction, shall immediately be reported upon discovery to the Department by telephone at the above number.

(c) A written report shall be submitted to the Department within five (5) business days following the notification of the incident, and shall describe, at a minimum, the following:

- (1) The malfunction(s);
- (2) The emission(s);
- (3) The duration; and
- (4) Any corrective action taken.

016 [25 Pa. Code §127.441]**Operating permit terms and conditions.**

[Additional authority for this permit condition is also derived from 25 Pa. Code § 127.511(c)]

The permittee shall submit the following reports:

(a) An annual certificate of compliance, due by April 1st of each year, for the period covering January 1 through December 31 of the previous year. This certificate of compliance shall document compliance with all permit terms and conditions set forth in this Title V permit as required under condition #26 of section B of this permit. The annual certificate of compliance shall be submitted to the Department in paper form, and EPA Region III in electronic form at the following email address: R3_APD_Permits@epa.gov

(b) A semi annual deviation report, due by October 1, of each year, for the period covering January 1 through June 30 of the same year. Note: The annual certification of compliance fulfills the obligation for the second deviation reporting period (July 1 through December 31 of the previous year).

017 [25 Pa. Code §127.441]**Operating permit terms and conditions.**

Within thirty (30) days after permit re-issuance, the permittee shall submit to the Department for approval any revised recordkeeping formats required per this Title V Operating Permit.

018 [25 Pa. Code §135.21]**Emission statements**

The permittee shall submit by March 1, of each year, an annual emission statement for the preceding calendar year. The statement shall contain calculation methods and time periods over which the calculations were made.

019 [25 Pa. Code §135.3]**Reporting**

The permittee, who has been previously advised by the Department to submit a source report, shall submit by March 1, of each year, a source report for the preceding calendar year. The report shall include information from all previously reported sources, new sources which were first operated during the preceding calendar year, and sources modified during the same period which were not previously reported, including those sources listed in the Miscellaneous Section of this permit.

VI. WORK PRACTICE REQUIREMENTS.**# 020 [25 Pa. Code §123.1]****Prohibition of certain fugitive emissions**

A person responsible for any source specified in Condition #002, of this section, shall take all reasonable actions to prevent particulate matter from becoming airborne. These actions shall include, but not be limited to, the following:

(a) Use, where possible, of water or suitable chemicals, as approved by the Department, for control of dust in the demolition of buildings or structures, construction operations, the grading of roads, or the clearing of land.

(b) Application of asphalt, water, or other suitable chemicals, as approved by the Department, on dirt roads, material



SECTION C. Site Level Requirements

stockpiles and other surfaces which may give rise to airborne dusts.

(c) Paving and maintenance of roadways.

(d) Prompt removal of earth or other material from paved streets onto which earth or other material has been transported by trucking or earth moving equipment, erosion by water, or by other means.

021 [25 Pa. Code §127.441]
Operating permit terms and conditions.
 The permittee shall ensure that the sources and air pollution control devices listed in Sections A and G of this permit, are operated and maintained in a manner consistent with good operating and maintenance practices, and in accordance with manufacturers' specifications (where appropriate).

VII. ADDITIONAL REQUIREMENTS.

No additional requirements exist except as provided in other sections of this permit including Section B (Title V General Requirements).

VIII. COMPLIANCE CERTIFICATION.

No additional compliance certifications exist except as provided in other sections of this permit including Section B (relating to Title V General Requirements).

IX. COMPLIANCE SCHEDULE.

No compliance milestones exist.

***** Permit Shield In Effect *****

**SECTION D. Source Level Requirements**

Source ID: 035

Source Name: 2-ARC BUILD.BOILERS-6.28MMBTU EACH

Source Capacity/Throughput:

6.300 MMBTU/HR

12.560 MCF/HR

Natural Gas

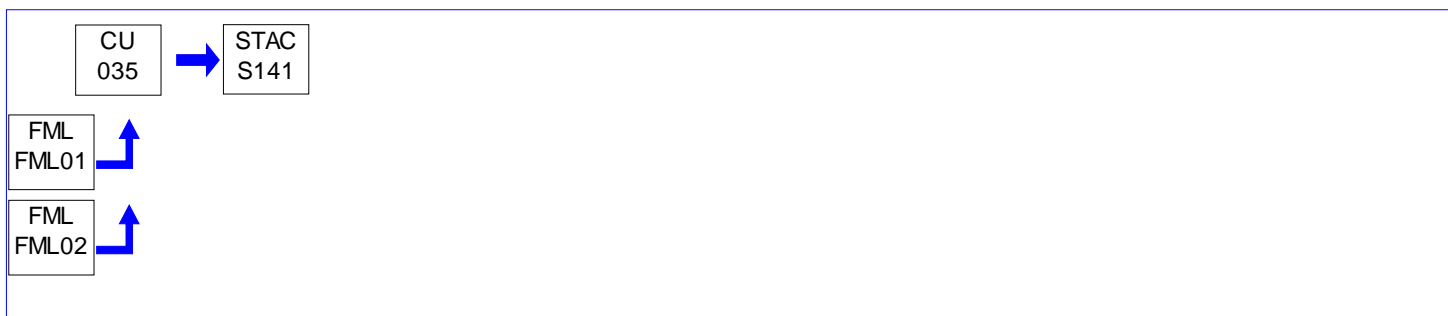
**I. RESTRICTIONS.****Emission Restriction(s).****# 001 [25 Pa. Code §123.11]****Combustion units**

The permittee may not permit the emission into the outdoor atmosphere of filterable particulate matter, as measured by Method 5 of 40 CFR 60, Appendix A (or an equivalent method approved by the Department), from any combustion unit in excess of the rate 0.4 pound per million BTU of heat input.

002 [25 Pa. Code §123.22]**Combustion units**

No person may permit the emission into the outdoor atmosphere of sulfur oxides (SO_x), expressed as SO₂, from any combustion unit, in the Southeast Air Basin, in excess of 1.2 pounds per million BTU of heat input, pursuant to 25 Pa. Code § 123.22(e)(1).

II. TESTING REQUIREMENTS.

No additional testing requirements exist except as provided in other sections of this permit including Section B (Title V General Requirements).

III. MONITORING REQUIREMENTS.**# 003 [25 Pa. Code §127.441]****Operating permit terms and conditions.**

The permittee shall monitor the total amount of fuel used, or the hours of operation for this source, on a monthly basis.

IV. RECORDKEEPING REQUIREMENTS.**# 004 [25 Pa. Code §127.441]****Operating permit terms and conditions.**

The permittee shall maintain records of the total amount of fuel used, or the hours of operation for this source, on a monthly basis.

V. REPORTING REQUIREMENTS.

No additional reporting requirements exist except as provided in other sections of this permit including Section B (Title V General Requirements).

VI. WORK PRACTICE REQUIREMENTS.**# 005 [25 Pa. Code §127.441]****Operating permit terms and conditions.**

[Additional authority for this permit condition is derived from 25 Pa. Code § 129.97(c)]



SECTION D. Source Level Requirements

(a) The permittee shall maintain and operate this source in accordance with the manufacturer's specifications and with good operating practices.

(b) In instances where the manufacturer's specification information is no longer available or applicable, the permittee shall ensure that the source shall be maintained and operated in a manner consistent with safety and good air pollution control practices for minimizing emissions.

VII. ADDITIONAL REQUIREMENTS.

No additional requirements exist except as provided in other sections of this permit including Section B (Title V General Requirements).

***** Permit Shield in Effect. *****

**SECTION D. Source Level Requirements**

Source ID: 055

Source Name: ELECTRIC MELT SHOP BOILER

Source Capacity/Throughput: 62.300 MMBTU/HR

62.300 MCF/HR Natural Gas

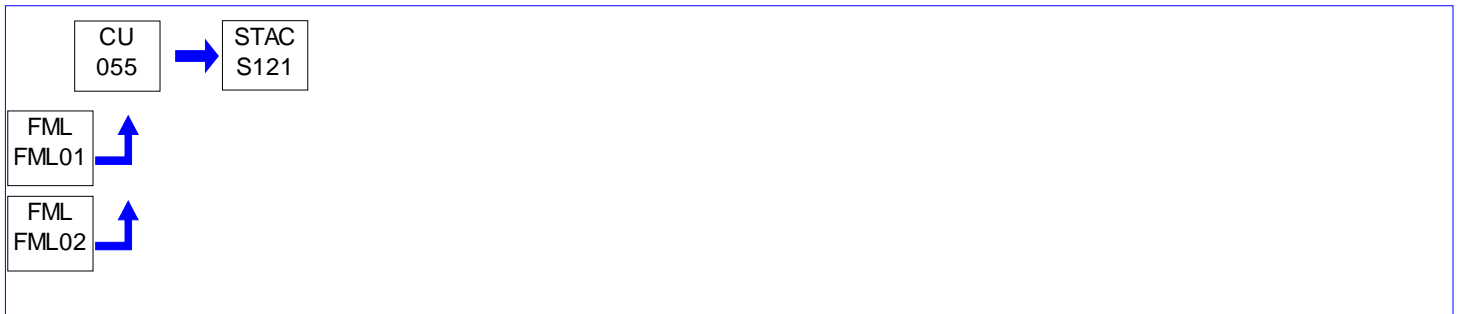
**I. RESTRICTIONS.****Emission Restriction(s).****# 001 [25 Pa. Code §123.11]****Combustion units**

A person may not permit the emission into the outdoor atmosphere of filterable particulate matter, as measured by Method 5 of 40 CFR 60, Appendix A (or an equivalent method approved by the Department), from a combustion unit in excess of 0.356 pounds per million BTU of heat input.

002 [25 Pa. Code §123.22]**Combustion units**

No person may permit the emission into the outdoor atmosphere of sulfur oxides (SO_x), expressed as SO₂, from any combustion unit, in the Southeast Air Basin, in excess of 1.2 pounds per million BTU of heat input, pursuant to 25 Pa. Code § 123.22(e)(1).

003 [25 Pa. Code §127.441]**Operating permit terms and conditions.**

[Additional authority for this permit condition is derived from 25 Pa. Code § 127.512(h) and 25 Pa. Code § 129.99]

Emissions of NO_x from this source shall not exceed the rate of 19.62 tons per 12-month rolling period.

Throughput Restriction(s).**# 004 [25 Pa. Code §127.441]****Operating permit terms and conditions.**

[Additional authority for this permit condition is derived from 25 Pa. Code § 127.512(h) and 25 Pa. Code § 129.99]

The permittee shall ensure that the amount of natural gas used by the Electric Melt Shop (EMS) Boiler (Source ID: 055) does not exceed 267 million cubic feet of natural gas in any consecutive twelve (12) month period.

II. TESTING REQUIREMENTS.**# 005 [25 Pa. Code §139.3]****General requirements.**

[Additional authority for this permit condition is derived from 25 Pa. Code § 129.100]

(a) The permittee shall perform a stack test using the Department-approved procedures once every five (5) calendar years, where five calendar years is defined as beginning with the calendar year the latest stack test was performed and ending on December 31, five years later. Performance tests shall be conducted while the source is operating at maximum routine operating conditions or under such other conditions, within the capacity of the equipment, as may be requested by the Department. When testing of a source is required on a recurring basis, a single procedural protocol may be submitted for approval; thereafter, a letter referencing the previously approved procedural protocol is sufficient. However, if modifications are made to the process(es), if a different stack testing company is used, or if an applicable section of the Department's Source Testing Manual has been revised since approval, a new protocol shall be submitted for approval.

**SECTION D. Source Level Requirements**

- (b) At least ninety (90) days prior to the test, the permittee shall submit to the Department for approval one paper copy plus one electronic copy to both the AQ Program Manager for the Southeast Regional Office and the PSIMS Administrator in Central Office the procedures for the test and a sketch with dimensions indicating the location of sampling ports and other data to ensure the collection of representative samples.
- (c) The stack test shall, at a minimum, test for NO_x to determine compliance with the lb/Mcf emission limit. Tests shall be conducted in accordance with the provisions of EPA Method 7 or other Department approved methodology and 25 Pa. Code Chapter 139.
- (d) At least thirty (30) days prior to the test, the AQ Program Manager for the Southeast Regional Office and the PSIMS Administrator in Central Office shall be informed of the date and time of the test.
- (e) Within sixty (60) days after the source test, the permittee shall submit one paper copy plus one electronic copy of the source test report to both the AQ Program Manager for the Southeast Regional Office and the PSIMS Administrator in Central Office.
- (f) In the event that any of the above deadlines cannot be met, the permittee may request an extension for the due date(s) in writing and include a justification for the extension. The Department may grant an extension for a reasonable cause.
- (g) Any questions or concerns about source testing submissions can be sent to RA-EPstacktesting@pa.gov and the PSIMS Administrator will address them. The following are the mail and email addresses for the AQ Program Manager for the Southeast Regional Office and the PSIMS Administrator in Central Office:

Central Office
 Pennsylvania Department of Environmental Protection
 Attn: PSIMS Administrator
 P.O. Box 8468
 Harrisburg, PA 17105-8468
 RA-EPstacktesting@pa.gov

Southeast Region
 Pennsylvania Department of Environmental Protection
 Attn: Air Quality Program Manager
 2 East Main Street
 Norristown, PA 19401
 RA-EPSEstacktesting@pa.gov

III. MONITORING REQUIREMENTS.**# 006 [25 Pa. Code §127.441]****Operating permit terms and conditions.**

[Additional authority for this permit condition is derived from 25 Pa. Code § 129.100]

- (a) The permittee shall monitor the amount of fuel consumed by this source on a monthly basis using a fuel meter or usage derived from production based data.
- (b) In the event of fuel meter malfunction, the permittee shall calculate the actual fuel usage using the fuel usage factor and amount of steel degassed for the current month.
- (c) The fuel usage factor (mcf/ton) is determined by averaging the amount of steel degassed and the amount of fuel used in the previous three (3) months, then dividing the average fuel usage by the average steel degassed.

IV. RECORDKEEPING REQUIREMENTS.**# 007 [25 Pa. Code §127.441]**

**SECTION D. Source Level Requirements****Operating permit terms and conditions.**

[Additional authority for this permit condition is derived from 25 Pa. Code § 129.100]

- (a) The permittee shall maintain records of the amount of fuel consumed by this source on a monthly basis and as a 12-month rolling sum using a fuel meter or usage derived from production based data.
- (b) The permittee shall calculate and record emissions of NO_x, in tons, on a monthly basis and as a 12-month rolling sum.

V. REPORTING REQUIREMENTS.

No additional reporting requirements exist except as provided in other sections of this permit including Section B (Title V General Requirements).

VI. WORK PRACTICE REQUIREMENTS.

No additional work practice requirements exist except as provided in other sections of this permit including Section B (Title V General Requirements).

VII. ADDITIONAL REQUIREMENTS.

No additional requirements exist except as provided in other sections of this permit including Section B (Title V General Requirements).

***** Permit Shield in Effect. *****

**SECTION D. Source Level Requirements**

Source ID: 104

Source Name: \D\ ELECTRIC FURNACE

Source Capacity/Throughput:	177.000 Tons/HR	CARBON/STAINLESS STEEL
	177.000 Tons/HR	ALLOY STEEL
	75.000 MCF/HR	Natural Gas

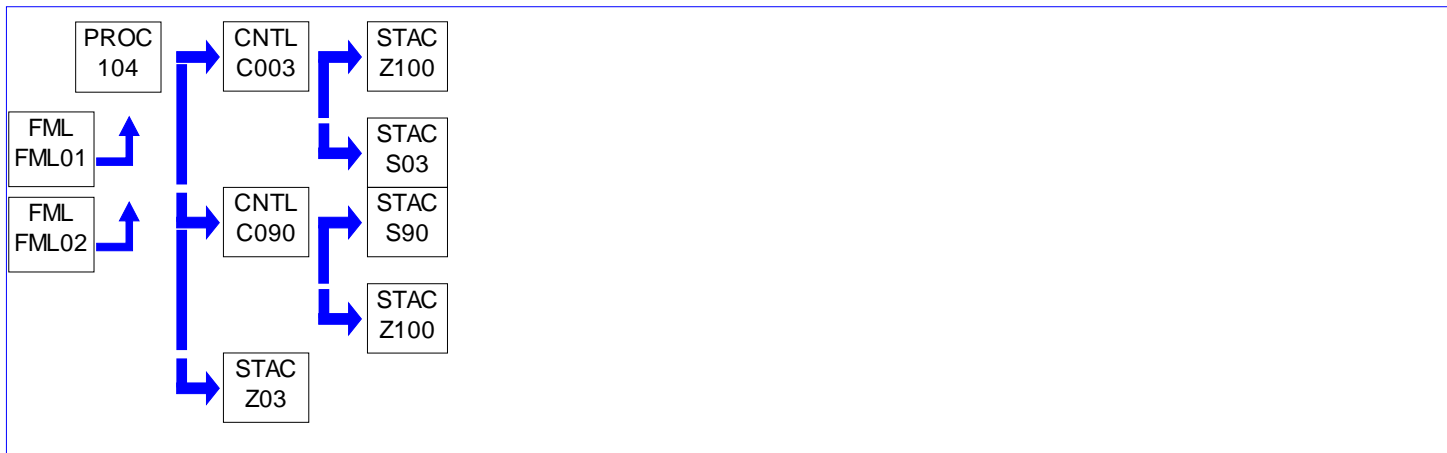
**I. RESTRICTIONS.****Emission Restriction(s).****# 001 [25 Pa. Code §123.13]****Processes**

See applicable particulate matter restrictions for this source under associated control devices - Source ID(s): C003 and C090.

002 [25 Pa. Code §123.21]**General**

No person may permit the emission into the outdoor atmosphere of sulfur oxides from this source in a manner that the concentration of the sulfur oxides, expressed as SO₂, in the effluent gas exceeds 500 ppmvd.

003 [25 Pa. Code §127.441]**Operating permit terms and conditions.**

[Additional authority for this permit condition is derived from 25 Pa. Code § 127.512(h) and 25 Pa. Code § 129.99]

(a) Emissions of nitrogen oxides (NO_x) from this source shall not exceed the following emission limits:

- (1) 34.1 tons on a monthly basis.
- (2) 340.6 tons per any 12-month rolling period.

(b) Emissions of volatile organic compounds (VOC) from this source shall not exceed the following emission limits:

- (1) 49.3 tons on a monthly basis.
- (2) 492.9 tons per any 12-month rolling period.

004 [40 CFR Part 63 NESHAPS for Source Categories §40 CFR 63.10686]**Subpart YYYYY - National Emission Standards for Hazardous Air Pollutants for Area Sources: Electric Arc Furnace Steelmaking Facilities****What are the requirements for electric arc furnaces and argon-oxygen decarburization vessels?**

The permittee may not discharge or cause the discharge into the atmosphere from the \D\ Electric Furnace any gases which:

(a) Exit from a control device and contain in excess of 0.0052 grains of filterable PM per dry standard cubic foot (gr/dscf), as measured by EPA Test Method 5 or 5D, pursuant to 40 CFR § 63.10686(d)(1)(v); and

(b) Exit from a melt shop and, due solely to the operations of the \D\ Electric Furnace, exhibit 6 percent opacity or greater.

**SECTION D. Source Level Requirements****Throughput Restriction(s).****# 005 [25 Pa. Code §127.441]****Operating permit terms and conditions.**

[Additional authority for this permit condition is derived from 25 Pa. Code § 127.512(h) and 25 Pa. Code § 129.99]

The permittee shall ensure that the Electric Arc Furnace "D" (Source ID: 104) melting operations shall be limited to 1.55 million tons of steel per year.

006 [40 CFR Part 63 NESHAPS for Source Categories §40 CFR 63.10685]**Subpart YYYYY - National Emission Standards for Hazardous Air Pollutants for Area Sources: Electric Arc Furnace Steelmaking Facilities****What are the requirements for the control of contaminants from scrap?**

For metallic scrap utilized in the \D\ Electric Furnace, the permittee shall comply with one of the following options (a) or (b). The facility may opt to comply with both options simultaneously, but only on the condition that scrap shall be kept segregated until charge make-up.

(a) For the production of steel other than leaded steel, the permittee shall prepare and implement a Department (or EPA) approved pollution prevention plan for metallic scrap selection and inspection to minimize the amount of chlorinated plastics, lead, and free organic liquids that is charged to the furnace. For the production of leaded steel, the permittee shall prepare and implement a Department (or EPA) approved pollution prevention plan for scrap selection and inspection to minimize the amount of chlorinated plastics and free organic liquids in the scrap that is charged to the furnace. The permittee shall operate according to the plan as submitted during the review and approval process, operate according to the approved plan at all times after approval, and address any deficiency identified by the permitting authority within 60 days following disapproval of a plan. The permittee may request approval to revise the plan and may operate according to the revised plan unless and until the revision is disapproved by the permitting authority. The permittee must keep a copy of the plan onsite, and must provide training on the plan's requirements to all plant personnel with materials acquisition or inspection duties. Each plan must include the following information:

(1) Specifications that scrap materials must be depleted (to the extent practicable) of undrained used oil filters, chlorinated plastics, and free organic liquids at the time of charging to the furnace.

(2) A requirement in the permittee's scrap specifications for removal (to the extent practicable) of lead-containing components (such as batteries, battery cables, and wheel weights) from the scrap, except for scrap used to produce leaded steel.

(3) Procedures for determining if the requirements and specifications in paragraph (a) of this condition are met (such as visual inspection or periodic audits of scrap providers) and procedures for taking corrective actions with vendors whose shipments are not within specifications.

(4) The requirements of paragraph (a) of this condition do not apply to the routine recycling of baghouse bags or other internal process or maintenance materials in the furnace. These exempted materials must be identified in the pollution prevention plan.

(b) For the production of steel other than leaded steel, the permittee may not charge to the \D\ Electric Furnace metallic scrap that contains scrap from motor vehicle bodies, engine blocks, oil filters, oily turnings, machine shop borings, transformers or capacitors containing polychlorinated biphenyls, lead-containing components, chlorinated plastics, or free organic liquids. For the production of leaded steel, the permittee may not charge to the furnace metallic scrap that contains scrap from motor vehicle bodies, engine blocks, oil filters, oily turnings, machine shop borings, transformers or capacitors containing polychlorinated biphenyls, chlorinated plastics, or free organic liquids.

(1) This restriction [paragraph (b), above] does not apply to any post-consumer engine blocks, post-consumer oil filters, or oily turnings that are processed or cleaned to the extent practicable such that the materials do not include lead components, chlorinated plastics, or free organic liquids.

(2) This restriction [paragraph (b), above] does not apply to motor vehicle scrap that is charged to recover the chromium or nickel content if you meet the the following requirements:

**SECTION D. Source Level Requirements**

- (i) The permittee must certify in the notification of compliance status that the only materials from motor vehicles in the scrap are materials recovered for their specialty alloy (including, but not limited to, chromium, nickel, molybdenum, or other alloys) content (such as certain exhaust systems); and,
- (ii) Based on the nature of the scrap and purchase specifications, that the type of scrap is not reasonably expected to contain mercury switches.

007 [40 CFR Part 63 NESHAPS for Source Categories §40 CFR 63.10685]**Subpart YYYYY - National Emission Standards for Hazardous Air Pollutants for Area Sources: Electric Arc Furnace Steelmaking Facilities****What are the requirements for the control of contaminants from scrap?**

(a) Mercury Requirements: For scrap containing motor vehicle scrap, the permittee shall procure the scrap pursuant to one of the compliance options in paragraphs (a)(1), (2), or (3) below for each scrap provider, contract, or shipment:

(1) Option 1: Site-specific Plan for Mercury Switches . The permittee shall comply with the following requirements:

- (i) The permittee shall include a requirement in the scrap specifications for removal of mercury switches from vehicle bodies used to make the scrap.
- (ii) The permittee shall prepare and operate according to a plan demonstrating how the facility will implement the scrap specification in paragraph (a)(1)(i) above for removal of mercury switches. The permittee shall submit the plan to the Department for approval. The permittee shall operate according to this plan as submitted during the review and approval process, operate according to the approved plan at all times after approval, and address any deficiency identified by the Department within 60 days following disapproval of a plan. The permittee may request approval to revise the plan and may operate according to the revised plan unless and until the revision is disapproved by the Department. The Department may change the approval status of the plan upon 90-days written notice based upon the semiannual compliance report or other information. The plan must include:
 - (A) A means of communicating to scrap purchasers and scrap providers the need to obtain or provide motor vehicle scrap from which mercury switches have been removed and the need to ensure the proper management of the mercury switches removed from that scrap as required under the rules implementing subtitle C of the Resource Conservation and Recovery Act (RCRA) (40 CFR parts 261 through 265 and 268). The plan must include documentation of direction to appropriate staff to communicate to suppliers throughout the scrap supply chain the need to promote the removal of mercury switches from end-of-life vehicles. Upon the request of the permitting authority, you must provide examples of materials that are used for outreach to suppliers, such as letters, contract language, policies for purchasing agents, and scrap inspection protocols;
 - (B) Provisions for obtaining assurance from scrap providers that motor vehicle scrap provided to the facility meet the scrap specification;
 - (C) Provisions for periodic inspections or other means of corroboration to ensure that scrap providers and dismantlers are implementing appropriate steps to minimize the presence of mercury switches in motor vehicle scrap and that the mercury switches removed are being properly managed, including the minimum frequency such means of corroboration will be implemented; and
 - (D) Provisions for taking corrective actions (i.e., actions resulting in scrap providers removing a higher percentage of mercury switches or other mercury-containing components) if needed, based on the results of procedures implemented in paragraph (a)(1)(ii)(C) above).
- (iii) The permittee shall require each motor vehicle scrap provider to provide an estimate of the number of mercury switches removed from motor vehicle scrap sent to your facility during the previous year and the basis for the estimate. The Department may request documentation or additional information at any time.
- (iv) The permittee shall establish a goal for each scrap provider to remove at least 80 percent of the mercury switches. Although an approved site-specific plan may require only the removal of convenience light switch

**SECTION D. Source Level Requirements**

mechanisms, the Department will credit all documented and verifiable mercury-containing components removed from motor vehicle scrap (such as sensors in anti-locking brake systems, security systems, active ride control, and other applications) when evaluating progress towards the 80 percent goal.

(v) For each scrap provider, the permittee shall submit semiannual progress reports to the Department that provide the number of mercury switches removed or the weight of mercury recovered from the switches, the estimated number of vehicles processed, an estimate of the percent of mercury switches removed, and certification that the removed mercury switches were recycled at RCRA-permitted facilities or otherwise properly managed pursuant to RCRA subtitle C regulations referenced in paragraph (a)(1)(ii)(A) of this condition. This information can be submitted in aggregated form and does not have to be submitted for each scrap provider, contract, or shipment. The Department may change the approval status of a site-specific plan following 90-days notice based on the progress reports or other information.

(2) Option 2: Approved Mercury Programs. The permittee shall certify in the notification of compliance status that the permittee participates in and purchases motor vehicle scrap only from scrap providers who participate in a program for removal of mercury switches that has been approved by the EPA based on the criteria in paragraphs (a)(2)(i) through (iii) below. If the permittee purchases motor vehicle scrap from a broker, the permittee must certify that all scrap received from that broker was obtained from other scrap providers who participate in a program for the removal of mercury switches that has been approved by the EPA based on the criteria in paragraphs (a)(2)(i) through (iii) of this condition. The National Vehicle Mercury Switch Recovery Program and the Vehicle Switch Recovery Program mandated by Maine State law are EPA-approved programs under paragraph (a)(2) of this condition unless and until the EPA disapproves the program (in part or in whole) under paragraph (a)(2)(iii) of this condition.

(i) The program includes outreach that informs the dismantlers of the need for removal of mercury switches and provides training and guidance for removing mercury switches;

(ii) The program has a goal to remove at least 80 percent of mercury switches from the motor vehicle scrap the scrap provider processes. Although a program approved under paragraph (a)(2) of this condition may require only the removal of convenience light switch mechanisms, EPA will credit all documented and verifiable mercury-containing components removed from motor vehicle scrap (such as sensors in anti-locking brake systems, security systems, active ride control, and other applications) when evaluating progress towards the 80 percent goal; and,

(iii) The program sponsor agrees to submit progress reports to the EPA (and the Department) no less frequently than once every year that provide the number of mercury switches removed or the weight of mercury recovered from the switches, the estimated number of vehicles processed, an estimate of the percent of mercury switches recovered, and certification that the recovered mercury switches were recycled at facilities with permits as required under the rules implementing subtitle C of RCRA (40 CFR parts 261 through 265 and 268). The progress reports must be based on a database that includes data for each program participant; however, data may be aggregated at the State level for progress reports that will be publicly available. EPA may change the approval status of a program or portion of a program (e.g., at the State level) following 90-days notice based on the progress reports or on other information.

(iv) The permittee shall develop and maintain onsite a plan demonstrating the manner through which the facility is participating in the EPA-approved program:

(A) The plan must include facility-specific implementation elements, corporate-wide policies, and/or efforts coordinated by a trade association as appropriate for each facility.

(B) The permittee shall provide in the plan documentation of direction to appropriate staff to communicate to suppliers throughout the scrap supply chain the need to promote the removal of mercury switches from end-of-life vehicles. Upon the request of the permitting authority, the permittee shall provide examples of materials that are used for outreach to suppliers, such as letters, contract language, policies for purchasing agents, and scrap inspection protocols.

**SECTION D. Source Level Requirements**

(C) The permittee shall conduct periodic inspections or provide other means of corroboration to ensure that scrap providers are aware of the need for and are implementing appropriate steps to minimize the presence of mercury in scrap from end-of-life vehicles.

(3) Option 3: Specialty Metal Scrap. The permittee shall certify in the notification of compliance status that the only materials from motor vehicles in the scrap are materials recovered for their specialty alloy (including, but not limited to, chromium, nickel, molybdenum, or other alloys) content (such as certain exhaust systems) and, based on the nature of the scrap and purchase specifications, that the type of scrap is not reasonably expected to contain mercury switches.

(b) For scrap that does not contain motor vehicle scrap, the permittee shall procure the scrap pursuant to the following for each scrap provider, contract, or shipment: the permittee shall certify in the notification of compliance status and maintain records of documentation that this scrap does not contain motor vehicle scrap.

II. TESTING REQUIREMENTS.

008 [25 Pa. Code §127.441]

Operating permit terms and conditions.

[Additional authority for this permit condition is derived from 25 Pa. Code § 129.100]

Refer to testing requirements under Source IDs C003 and C090.

III. MONITORING REQUIREMENTS.

009 [25 Pa. Code §127.441]

Operating permit terms and conditions.

[Additional authority for this permit condition is derived from 25 Pa. Code § 129.100]

The permittee shall monitor the steel throughput for the Electric Arc Furnace "D" (Source ID: 104) on a monthly basis.

010 [25 Pa. Code §127.441]

Operating permit terms and conditions.

The permittee shall monitor the monthly fuel usage or hours of operation for the Electric Arc Furnace "D" (Source ID: 104).

IV. RECORDKEEPING REQUIREMENTS.

011 [25 Pa. Code §127.441]

Operating permit terms and conditions.

[Additional authority for this permit condition is derived from 25 Pa. Code § 129.100]

(a) The permittee shall maintain steel throughput records for the Electric Arc Furnace "D" (Source ID: 104) on a monthly basis and as a 12-month rolling sum.

(b) The permittee shall calculate and record emissions of NO_x and VOC, in tons, on a monthly basis and as a 12-month rolling sum.

012 [25 Pa. Code §127.441]

Operating permit terms and conditions.

The permittee shall maintain monthly records of fuel usage or hours of operation for the Electric Arc Furnace "D" (Source ID: 104).

013 [40 CFR Part 63 NESHAPS for Source Categories §40 CFR 63.10685]

Subpart YYYYY - National Emission Standards for Hazardous Air Pollutants for Area Sources: Electric Arc Furnace Steelmaking Facilities**What are the requirements for the control of contaminants from scrap?**

The permittee shall keep records to demonstrate compliance with the following provisions, to the extent the permittee selects the referenced compliance option for managing scrap:

**SECTION D. Source Level Requirements**

- (a) The pollution prevention plan applicable to the \D\ Electric Furnace, when the permittee complies with 40 C.F.R. § 63.10685(a) by means of a pollution prevention plan;
- (b) The restriction that the permittee may not charge to the \D\ Electric Furnace metallic scrap that contains scrap from motor vehicle bodies, engine blocks, oil filters, oily turnings, machine shop borings, transformers or capacitors containing polychlorinated biphenyls, lead-containing components, chlorinated plastics, or free organic liquids, when the permittee complies with 40 C.F.R. § 63.10685(a) by means of this restriction;
- (c) If the permittee is subject to the requirements for a site-specific plan for mercury [40 CFR § 63.10685(b)(1)], the permittee must maintain records of the number of mercury switches removed or the weight of mercury recovered from the switches and properly managed, the estimated number of vehicles processed, and an estimate of the percent of mercury switches recovered;
- (d) If the permittee is subject to the option for approved mercury programs [40 CFR § 63.10685(b)(2)],
- (1) The permittee must maintain records identifying each scrap provider and documenting the scrap provider's participation in an approved mercury switch removal program. If the permittee purchases motor vehicle scrap from a broker, the permittee must maintain records identifying each broker and documentation that all scrap provided by the broker was obtained from other scrap providers who participate in an approved mercury switch removal program;
 - (2) The permittee must maintain onsite a plan demonstrating the manner through which the facility is participating in the EPA-approved program.
- (e) For scrap that does not contain motor vehicle scrap and that is not subject to the requirements of 40 C.F.R. 63.10685(b)(1)-(3) [40 C.F.R. § 63.10685(b)(4)], the permittee must maintain records of documentation that this scrap does not contain motor vehicle scrap;
- (f) The permittee shall maintain, as applicable, records of all semiannual compliance reports and notifications of compliance status required by 40 CFR §§ 63.10685.

014 [40 CFR Part 63 NESHAPS for Source Categories §40 CFR 63.10690]
Subpart YYYYY - National Emission Standards for Hazardous Air Pollutants for Area Sources: Electric Arc Furnace Steelmaking Facilities
What parts of the General Provisions apply to this subpart?

[Additional authority for this permit condition is also derived from 40 CFR § 63.6]

The permittee shall maintain on site at all times a startup, shutdown, and malfunction plan which conforms to the provisions of 40 CFR Part 63.6(e).

015 [40 CFR Part 63 NESHAPS for Source Categories §40 CFR 63.10690]
Subpart YYYYY - National Emission Standards for Hazardous Air Pollutants for Area Sources: Electric Arc Furnace Steelmaking Facilities
What parts of the General Provisions apply to this subpart?

[Additional authority for this permit condition is also derived from 40 CFR § 63.10]

(a) The permittee shall maintain files of all information (including all reports and notification) required under 40 CFR Part 63, Subpart YYYYY, recorded in a form suitable and readily available for expeditious inspection and review. The files shall be retained for at least 5 years following the date of each occurrence, measurement, maintenance, corrective action, report, or record. At a minimum, the most recent 2 years of data shall be retained on site. The remaining 3 years of data may be retained off site. Such files may be maintained on microfilm, on a computer, on computer floppy disks, on magnetic tape disks, or on microfiche.

(b) The permittee shall document and maintain records for the following:

- (1) The occurrence and duration of each startup or shutdown when the startup or shutdown causes the source to exceed any applicable emission limitation in the relevant emission standards;

**SECTION D. Source Level Requirements**

- (2) The occurrence and duration of each malfunction of operation (i.e., process equipment) or the required air pollution control and monitoring equipment;
- (3) All required maintenance performed on the air pollution control and monitoring equipment;
- (4) Actions taken during periods of startup or shutdown when the source exceeded applicable emission limitations in a relevant standard and when the actions taken are different from the procedures specified in the affected source's startup, shutdown, and malfunction plan or for actions taken during periods of malfunction (including corrective actions to restore malfunctioning process and air pollution control and monitoring equipment to its normal or usual manner of operation) when the actions taken are different from the procedures specified in the affected source's startup, shutdown, and malfunction plan;
- (5) All information necessary, including actions taken, to demonstrate conformance with the affected source's startup, shutdown, and malfunction plan when all actions taken during periods of startup or shutdown (and the startup or shutdown causes the source to exceed any applicable emission limitation in the relevant emission standards), and malfunction (including corrective actions to restore malfunctioning process and air pollution control and monitoring equipment to its normal or usual manner of operation) are consistent with the procedures specified in such plan. The information needed to demonstrate conformance with the startup, shutdown, and malfunction plan may be recorded using a "checklist," or some other effective form of recordkeeping, in order to minimize the recordkeeping burden for conforming events;
- (6) All documentation supporting initial notifications and notifications of compliance status under 40 CFR § 63.9.

V. REPORTING REQUIREMENTS.**# 016 [40 CFR Part 63 NESHAPS for Source Categories §40 CFR 63.10685]****Subpart YYYYY - National Emission Standards for Hazardous Air Pollutants for Area Sources: Electric Arc Furnace Steelmaking Facilities****What are the requirements for the control of contaminants from scrap?**

- (a) If the permittee is subject to the option for approved mercury programs [40 CFR § 63.10685(b)(2)], the permittee must certify in a notification of compliance status that the permittee participates in and purchases motor vehicle scrap only from scrap providers who participate in a program for removal of mercury switches that has been approved by the EPA. If the permittee purchases motor vehicle scrap from a broker, the permittee must certify that all scrap received from that broker was obtained from other scrap providers who participate in a program for the removal of mercury switches that has been approved by the EPA.
- (b) If the permittee is subject to the option for specialty metal scrap [40 CFR § 63.10685(b)(3)], the permittee must certify in a notification of compliance status that the only materials from motor vehicles in the scrap are materials recovered for their specialty alloy (including, but not limited to, chromium, nickel, molybdenum, or other alloys) content (such as certain exhaust systems) and, based on the nature of the scrap and purchase specifications, that the type of scrap is not reasonably expected to contain mercury switches.
- (c) For scrap not subject to the requirements in paragraphs 40 CFR § 63.10685(b)(1) - (3), the permittee must certify in a notification of compliance status that this scrap does not contain motor vehicle scrap.

017 [40 CFR Part 63 NESHAPS for Source Categories §40 CFR 63.10685]**Subpart YYYYY - National Emission Standards for Hazardous Air Pollutants for Area Sources: Electric Arc Furnace Steelmaking Facilities****What are the requirements for the control of contaminants from scrap?**

- (a) If the permittee is subject to the requirements for a site-specific plan for mercury [40 CFR § 63.10685(b)(1)], the permittee must submit semiannual reports of the number of mercury switches removed or the weight of mercury recovered from the switches and properly managed, the estimated number of vehicles processed, an estimate of the percent of mercury switches recovered, and a certification that the recovered mercury switches were recycled at RCRA-permitted facilities. The semiannual reports must include a certification that the permittee has conducted inspections or taken other means of corroboration as required under 40 CFR § 63.10685(b)(1)(ii)(C). The permittee may include this information in the semiannual compliance reports required under 40 CFR § 63.10685(c)(3).

**SECTION D. Source Level Requirements**

(b) The permittee must submit semiannual compliance reports to the Department and EPA for the control of contaminants from scrap. The report must clearly identify any deviation from the requirements in 40 CFR § 63.10685 and the corrective action taken. The permittee must identify which compliance option in 40 CFR § 63.10685(b) applies to each scrap provider, contract, or shipment.

018 [40 CFR Part 63 NESHAPS for Source Categories §40 CFR 63.10690]

Subpart YYYYY - National Emission Standards for Hazardous Air Pollutants for Area Sources: Electric Arc Furnace Steelmaking Facilities

What parts of the General Provisions apply to this subpart?

[Additional authority for this permit condition is also derived from 40 CFR § 63.10]

(a) Periodic startup, shutdown, and malfunction reports. If actions taken by the permittee during a startup or shutdown (and the startup or shutdown causes the source to exceed any applicable emission limitation in the relevant emission standards), or malfunction of an affected source (including actions taken to correct a malfunction) are consistent with the procedures specified in the source's startup, shutdown, and malfunction plan (see 40 CFR § 63.6(e)(3)), the permittee shall state such information in a startup, shutdown, and malfunction report. Actions taken to minimize emissions during such startups, shutdowns, and malfunctions shall be summarized in the report and may be done in checklist form; if actions taken are the same for each event, only one checklist is necessary. Such a report shall also include the number, duration, and a brief description for each type of malfunction which occurred during the reporting period and which caused or may have caused any applicable emission limitation to be exceeded. Reports shall only be required if a startup or shutdown caused the source to exceed any applicable emission limitation in the relevant emission standards, or if a malfunction occurred during the reporting period. The startup, shutdown, and malfunction report shall consist of a letter, containing the name, title, and signature of the permittee or other responsible official who is certifying its accuracy, that shall be submitted to the EPA and the Department semiannually (or on a more frequent basis if specified otherwise in a relevant standard or as established otherwise by the permitting authority in the source's title V permit). The startup, shutdown, and malfunction report shall be delivered or postmarked by the 30th day following the end of each calendar half (or other calendar reporting period, as appropriate). If the permittee is required to submit excess emissions and continuous monitoring system performance (or other periodic) reports, the startup, shutdown, and malfunction reports may be submitted simultaneously with the excess emissions and continuous monitoring system performance (or other) reports. If startup, shutdown, and malfunction reports are submitted with excess emissions and continuous monitoring system performance (or other periodic) reports, and the permittee receives approval to reduce the frequency of reporting for the latter, the frequency of reporting for the startup, shutdown, and malfunction reports also may be reduced if the EPA and the Department do not object to the intended change. The procedures to implement the allowance is outlined under 40 CFR § 63.10(e)(3) of this section.

(b) Immediate startup, shutdown, and malfunction reports. Notwithstanding the allowance to reduce the frequency of reporting for periodic startup, shutdown, and malfunction reports, any time an action taken by a permittee during a startup or shutdown that caused the source to exceed any applicable emission limitation in the relevant emission standards, or malfunction (including actions taken to correct a malfunction) is not consistent with the procedures specified in the affected source's startup, shutdown, and malfunction plan, the permittee shall report the actions taken for that event within 2 working days after commencing actions inconsistent with the plan followed by a letter within 7 working days after the end of the event. The immediate report required per 40 CFR § 63.10(d)(5)(ii) shall consist of a telephone call (or facsimile (FAX) transmission) to the EPA and the Department within 2 working days after commencing actions inconsistent with the plan, and it shall be followed by a letter, delivered or postmarked within 7 working days after the end of the event, that contains the name, title, and signature of the permittee or other responsible official who is certifying its accuracy, explaining the circumstances of the event, the reasons for not following the startup, shutdown, and malfunction plan, describing all excess emissions and/or parameter monitoring exceedances which are believed to have occurred (or could have occurred in the case of malfunctions), and actions taken to minimize emissions in conformance with 40 CFR § 63.6(e)(1)(i). Notwithstanding the requirements of the previous sentence, after the effective date of an approved permit program in the State in which an affected source is located, the permittee may make alternative reporting arrangements, in advance, with the permitting authority in that State. Procedures governing the arrangement of alternative reporting requirements are specified in 40 CFR § 63.9(i).

**SECTION D. Source Level Requirements****VI. WORK PRACTICE REQUIREMENTS.****# 019 [25 Pa. Code §127.441]****Operating permit terms and conditions.**

[Additional authority for this permit condition is also derived from 40 CFR §§ 63.6(e) and 63.10686]

- (a) The permittee shall ensure that the pollutant emissions from the \D\ Electric Furnace (including charging, melting, and tapping operations) are ducted to Baghouses A, B, and D (Source ID: C003) and Baghouse E (Source ID: C090).
- (b) At all times, including periods of startup, shutdown, and malfunction, the permittee must operate and maintain any affected source, including associated air pollution control equipment and monitoring equipment, in a manner consistent with safety and good air pollution control practices for minimizing emissions. During a period of startup, shutdown, or malfunction, this general duty to minimize emissions requires that the permittee reduce emissions from the affected source to the greatest extent which is consistent with safety and good air pollution control practices. The general duty to minimize emissions during a period of startup, shutdown, or malfunction does not require the permittee to achieve emission levels that would be required by the applicable standard at other times if this is not consistent with safety and good air pollution control practices, nor does it require the permittee to make any further efforts to reduce emissions if levels required by the applicable standard have been achieved. Determination of whether such operation and maintenance procedures are being used will be based on information available to the Department which may include, but is not limited to, monitoring results, review of operation and maintenance procedures [including the startup, shutdown, and malfunction plan required in 40 CFR § 63.6(e)(3)], review of operation and maintenance records, and inspection of the source.
- (c) Malfunctions must be corrected as soon as practicable after their occurrence. To the extent that an unexpected event arises during a startup, shutdown, or malfunction, the permittee must comply by minimizing emissions during such a startup, shutdown, and malfunction event consistent with safety and good air pollution control practices.

020 [40 CFR Part 63 NESHAPS for Source Categories §40 CFR 63.10685]**Subpart YYYYY - National Emission Standards for Hazardous Air Pollutants for Area Sources: Electric Arc Furnace Steelmaking Facilities****What are the requirements for the control of contaminants from scrap?**

If the permittee is subject to the option for approved mercury programs [40 CFR § 63.10685(b)(2)], the permittee must conduct periodic inspections or provide other means of corroboration to ensure that scrap providers are aware of the need for and are implementing appropriate steps to minimize the presence of mercury in scrap from end-of-life vehicles.

021 [40 CFR Part 63 NESHAPS for Source Categories §40 CFR 63.10690]**Subpart YYYYY - National Emission Standards for Hazardous Air Pollutants for Area Sources: Electric Arc Furnace Steelmaking Facilities****What parts of the General Provisions apply to this subpart?**

[Additional authority for this permit condition is also derived from 40 CFR § 63.6]

The permittee shall develop a startup, shutdown, and malfunction plan which conforms to the provisions of 40 CFR Part 63.6(e) and minimizes emissions from the \D\ Electric Furnace.

VII. ADDITIONAL REQUIREMENTS.

No additional requirements exist except as provided in other sections of this permit including Section B (Title V General Requirements).

***** Permit Shield in Effect. *****

**SECTION D. Source Level Requirements**

Source ID: 136

Source Name: BATCH HT.TRT.FURNACES 2-8 & 10

Source Capacity/Throughput: 284.700 MCF/HR Natural Gas

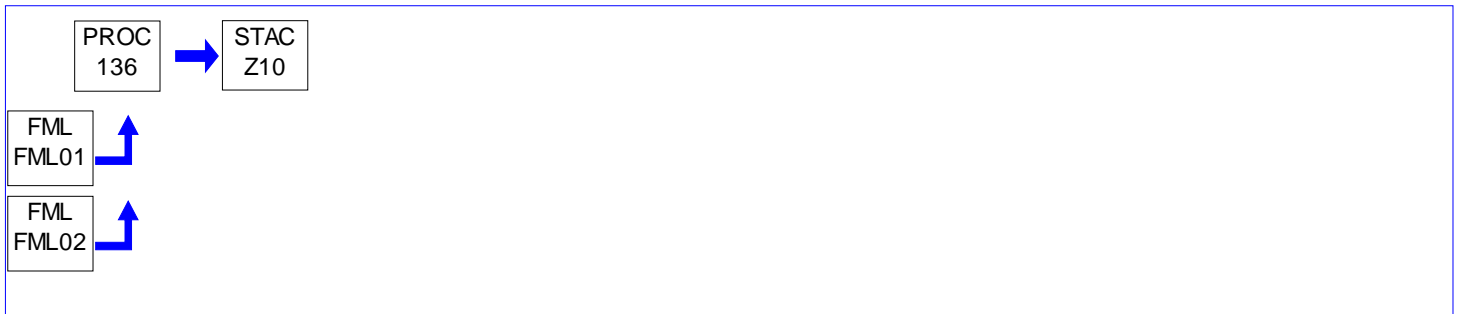
**I. RESTRICTIONS.****Emission Restriction(s).****# 001 [25 Pa. Code §123.13]****Processes**

The permittee may not permit the emission into the outdoor atmosphere of filterable particulate matter, as measured by Method 5 of 40 CFR 60, Appendix A (or an equivalent method approved by the Department), in a manner that the concentration of particulate matter in the effluent gas exceeds 0.04 grains per dry standard cubic foot.

002 [25 Pa. Code §123.21]**General**

The permittee may not permit the emission into the outdoor atmosphere of sulfur oxides from a source in a manner that the concentration of the sulfur oxides, expressed as SO₂, in the effluent gas exceeds 500 parts per million, by volume, dry basis.

003 [25 Pa. Code §127.441]**Operating permit terms and conditions.**

[Additional authority for this permit condition is derived from 25 Pa. Code § 127.512(h) and 25 Pa. Code § 129.99]

The permittee shall ensure that the total emissions of NO_x from the combined sources under Source ID 136 shall not exceed 173.6 tons per twelve (12) month rolling period.

Fuel Restriction(s).**# 004 [25 Pa. Code §127.441]****Operating permit terms and conditions.**

[Additional authority for this permit condition is derived from 25 Pa. Code § 127.512(h) and 25 Pa. Code § 129.99]

The permittee shall ensure that the total amount of fuel used by the combined sources under Source ID 136 shall not exceed 2,495.7 million cubic feet of natural gas per year, as a twelve (12) month rolling sum.

II. TESTING REQUIREMENTS.

No additional testing requirements exist except as provided in other sections of this permit including Section B (Title V General Requirements).

III. MONITORING REQUIREMENTS.**# 005 [25 Pa. Code §127.441]****Operating permit terms and conditions.**

[Additional authority for this permit condition is derived from 25 Pa. Code § 129.100]

The permittee shall monitor the volume of fuel used or the hours of operation to determine the fuel usage for this source on a monthly basis.

**SECTION D. Source Level Requirements****IV. RECORDKEEPING REQUIREMENTS.****# 006 [25 Pa. Code §127.441]****Operating permit terms and conditions.**

[Additional authority for this permit condition is derived from 25 Pa. Code § 129.100]

- (a) The permittee shall calculate and record the volume of fuel used for this source on a monthly basis and on a 12-month rolling basis.
- (b) The permittee shall record the NO_x emissions from this source on a monthly basis and on a 12-month rolling basis.

V. REPORTING REQUIREMENTS.

No additional reporting requirements exist except as provided in other sections of this permit including Section B (Title V General Requirements).

VI. WORK PRACTICE REQUIREMENTS.

No additional work practice requirements exist except as provided in other sections of this permit including Section B (Title V General Requirements).

VII. ADDITIONAL REQUIREMENTS.**# 007 [25 Pa. Code §127.441]****Operating permit terms and conditions.**

This source group (Source ID: 136) consists of eight (8) Batch Heat Treat Furnaces fired on natural gas (Source ID(s): 136, 137, 138, 139, 140, 141, 142 & 144).

***** Permit Shield in Effect. *****

**SECTION D. Source Level Requirements**

Source ID: 146A

Source Name: 145' NAB FURNACE (CHT)

Source Capacity/Throughput:

55.000 MCF/HR

Natural Gas

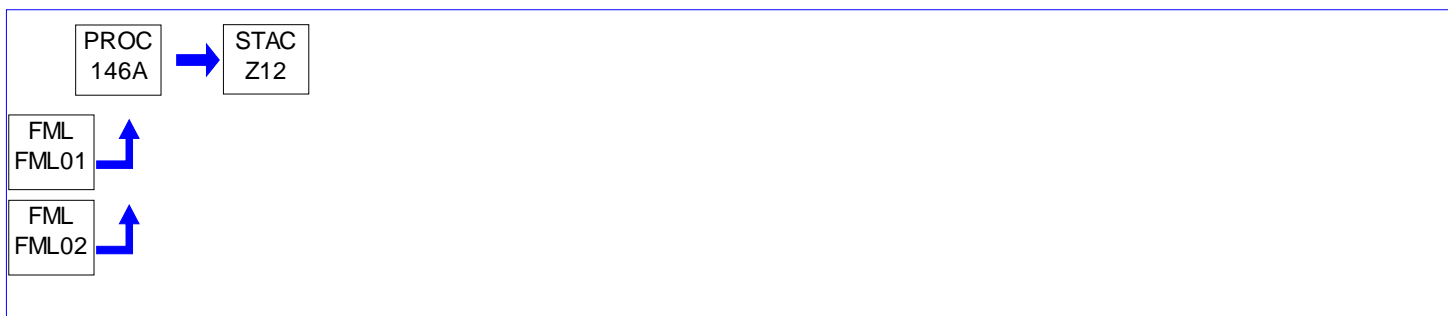
**I. RESTRICTIONS.****Emission Restriction(s).****# 001 [25 Pa. Code §123.13]****Processes**

The permittee may not permit the emission into the outdoor atmosphere of filterable particulate matter, as measured by Method 5 of 40 CFR 60, Appendix A (or an equivalent method approved by the Department), in a manner that the concentration of particulate matter in the effluent gas exceeds 0.04 grains per dry standard cubic foot.

002 [25 Pa. Code §123.21]**General**

The permittee may not permit the emission into the outdoor atmosphere of sulfur oxides from a source in a manner that the concentration of the sulfur oxides, expressed as SO₂, in the effluent gas exceeds 500 parts per million, by volume, dry basis.

003 [25 Pa. Code §127.441]**Operating permit terms and conditions.**

[Additional authority for this permit condition is derived from 25 Pa. Code § 127.512(h) and 25 Pa. Code § 129.99]

Emissions of nitrogen oxides (NO_x) from the 145' NAB Furnace (CHT) shall not exceed 33.7 tons per year as a twelve (12) month rolling sum

Throughput Restriction(s).**# 004 [25 Pa. Code §127.441]****Operating permit terms and conditions.**

[Additional authority for this permit condition is derived from 25 Pa. Code § 127.512(h) and 25 Pa. Code § 129.99]

The permittee shall ensure that the amount of fuel used by the 145' NAB Furnace (CHT) shall not exceed 481.8 million cubic feet of natural gas per year, as a twelve (12) month rolling sum.

II. TESTING REQUIREMENTS.

No additional testing requirements exist except as provided in other sections of this permit including Section B (Title V General Requirements).

III. MONITORING REQUIREMENTS.**# 005 [25 Pa. Code §127.441]****Operating permit terms and conditions.**

[Additional authority for this permit condition is derived from 25 Pa. Code § 129.100]

The permittee shall monitor the fuel usage or hours of operation to determine the fuel usage for the 145' NAB Furnace (CHT) on a monthly basis.

**SECTION D. Source Level Requirements****IV. RECORDKEEPING REQUIREMENTS.****# 006 [25 Pa. Code §127.441]****Operating permit terms and conditions.**

[Additional authority for this permit condition is derived from 25 Pa. Code § 129.100]

The permittee shall calculate and record NOx emissions, in tons, and fuel usage from the 145' NAB Furnace (CHT) on a monthly basis and on a twelve (12) month rolling basis.

V. REPORTING REQUIREMENTS.

No additional reporting requirements exist except as provided in other sections of this permit including Section B (Title V General Requirements).

VI. WORK PRACTICE REQUIREMENTS.**# 007 [25 Pa. Code §127.441]****Operating permit terms and conditions.**

The permittee shall ensure that the 145' NAB Furnace (CHT) shall be equipped with a gauge to monitor the fuel usage for the furnace.

VII. ADDITIONAL REQUIREMENTS.

No additional requirements exist except as provided in other sections of this permit including Section B (Title V General Requirements).

***** Permit Shield in Effect. *****

**SECTION D. Source Level Requirements**

Source ID: 146B

Source Name: 200' NAB FURNACE (CHT)

Source Capacity/Throughput: 128.000 MMBTU/HR

128.000 MCF/HR Natural Gas

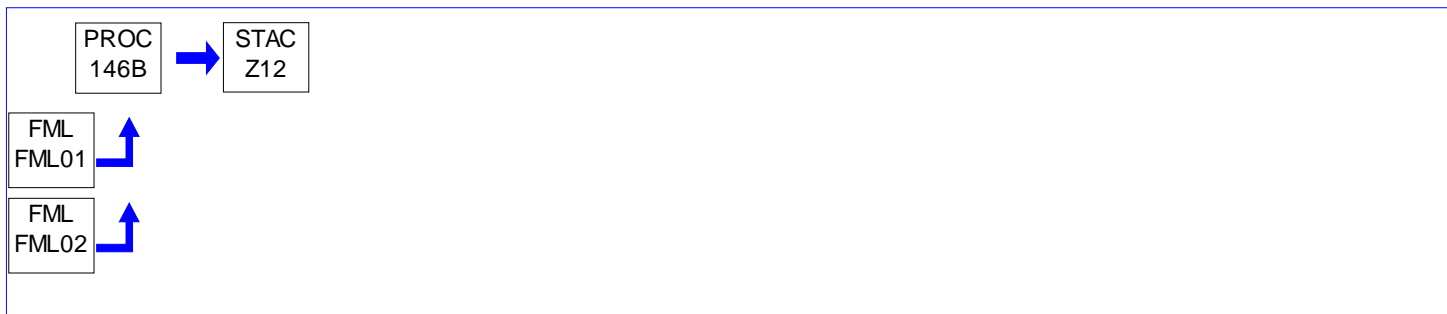
**I. RESTRICTIONS.****Emission Restriction(s).****# 001 [25 Pa. Code §123.13]****Processes**

The permittee may not permit the emission into the outdoor atmosphere of filterable particulate matter, as measured by Method 5 of 40 CFR 60, Appendix A (or an equivalent method approved by the Department), in a manner that the concentration of particulate matter in the effluent gas exceeds 0.04 grains per dry standard cubic foot.

002 [25 Pa. Code §123.21]**General**

No person may permit the emission into the outdoor atmosphere of sulfur oxides from this source in a manner that the concentration of the sulfur oxides, expressed as SO₂, in the effluent gas exceeds 500 ppmvd.

003 [25 Pa. Code §127.441]**Operating permit terms and conditions.**

[Additional authority for this permit condition is derived from 25 Pa. Code § 127.512(h) and 25 Pa. Code § 129.99]

The permittee shall ensure that the emissions of nitrogen oxides (NO_x) from the 200' NAB Furnace (CHT) shall not exceed 30.6 tons per year, as a twelve (12) month rolling sum.

004 [25 Pa. Code §127.441]**Operating permit terms and conditions.**

[Additional authority for this permit condition is derived from 25 Pa. Code § 127.1 and 25 Pa. Code § 127.512(h)]

The permittee shall ensure that the emissions of nitrogen oxide (NO_x) from the 200' NAB Furnace (CHT) shall not exceed 120 lbs per million cubic foot of natural gas.

Throughput Restriction(s).**# 005 [25 Pa. Code §127.441]****Operating permit terms and conditions.**

[Additional authority for this permit condition is derived from 25 Pa. Code § 127.512(h) and 25 Pa. Code § 129.99]

The permittee shall ensure that the fuel usage of the 200' NAB Furnace (CHT) shall not exceed 510.0 million cubic feet of natural gas per year, as a twelve (12) month rolling sum.

II. TESTING REQUIREMENTS.

No additional testing requirements exist except as provided in other sections of this permit including Section B (Title V General Requirements).

**SECTION D. Source Level Requirements****III. MONITORING REQUIREMENTS.****# 006 [25 Pa. Code §127.441]****Operating permit terms and conditions.**

[Additional authority for this permit condition is derived from 25 Pa. Code § 129.100]

The permittee shall monitor the fuel usage or hours of operation to determine the fuel usage for the 200' NAB Furnace (CHT) on a monthly basis.

IV. RECORDKEEPING REQUIREMENTS.**# 007 [25 Pa. Code §127.441]****Operating permit terms and conditions.**

[Additional authority for this permit condition is derived from 25 Pa. Code § 129.100]

The permittee shall ensure that the NO_x emissions, in tons, and fuel usage are calculated and recorded on a monthly basis and as a twelve (12) month rolling sum.

V. REPORTING REQUIREMENTS.

No additional reporting requirements exist except as provided in other sections of this permit including Section B (Title V General Requirements).

VI. WORK PRACTICE REQUIREMENTS.**# 008 [25 Pa. Code §127.441]****Operating permit terms and conditions.**

The permittee shall ensure that the 200' NAB Furnace (CHT) shall be equipped with a gauge to monitor the fuel usage for this source on a monthly basis.

VII. ADDITIONAL REQUIREMENTS.

No additional requirements exist except as provided in other sections of this permit including Section B (Title V General Requirements).

***** Permit Shield in Effect. *****

**SECTION D. Source Level Requirements**

Source ID: 151

Source Name: 15 SOAKING PITS

Source Capacity/Throughput: 450.000 MCF/HR Natural Gas

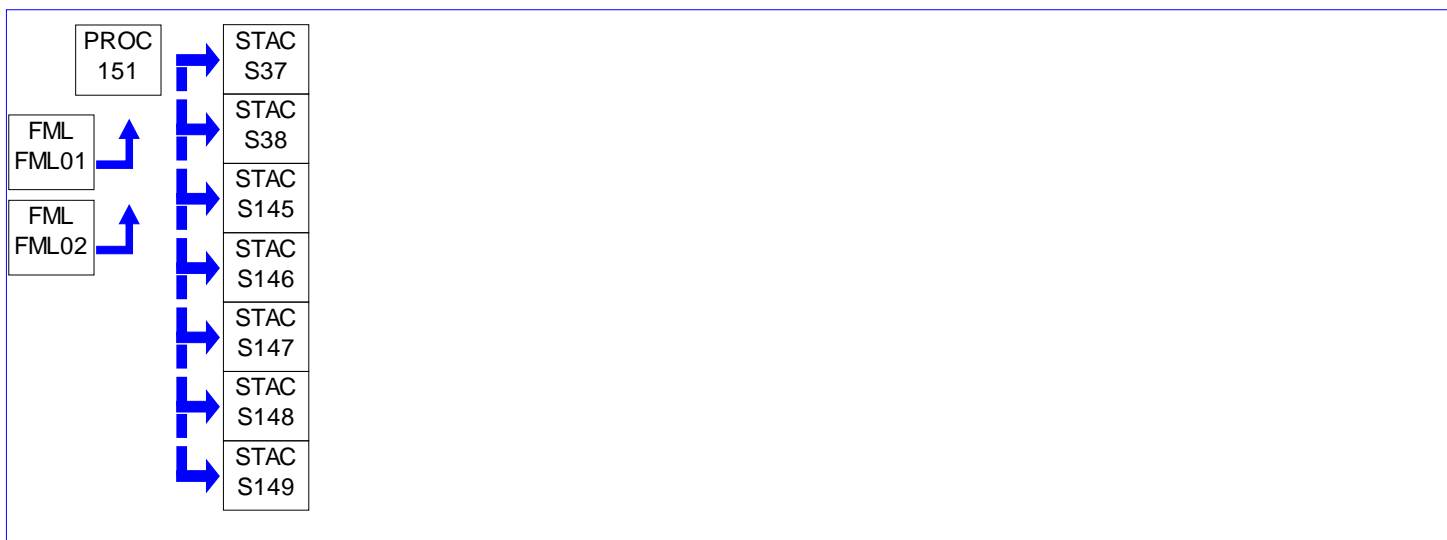
**I. RESTRICTIONS.****Emission Restriction(s).****# 001 [25 Pa. Code §123.13]****Processes**

The permittee may not permit the emission into the outdoor atmosphere of filterable particulate matter, as measured by Method 5 of 40 CFR 60, Appendix A (or an equivalent method approved by the Department), in a manner that the concentration of particulate matter in the effluent gas exceeds 0.04 grains per dry standard cubic foot.

002 [25 Pa. Code §123.21]**General**

The permittee may not permit the emission into the outdoor atmosphere of sulfur oxides from a source in a manner that the concentration of the sulfur oxides, expressed as SO₂, in the effluent gas exceeds 500 parts per million, by volume, dry basis.

003 [25 Pa. Code §127.441]**Operating permit terms and conditions.**

[Additional authority for this permit condition is derived from 25 Pa. Code § 127.512(h) and 25 Pa. Code § 129.99]

The permittee shall ensure that the emissions of NO_x from the combined sources under Source ID 151 do not exceed 502.8 tons per twelve (12) month rolling period.

Throughput Restriction(s).**# 004 [25 Pa. Code §127.441]****Operating permit terms and conditions.**

[Additional authority for this permit condition is derived from 25 Pa. Code § 127.512(h) and 25 Pa. Code § 129.99]

The permittee shall ensure that the following sources associated with this source group (Source ID: 151 - 15 Soaking Pits) shall not consume more than 3,942 million cubic feet of natural gas per year as a twelve (12) month rolling sum: Soaking Pits No(s). 35, 36, 37, 38, 39, 40, 41, 42, 43, 44, 45, 46, 47, 48, 49, (Source ID(s): 159, 160, 161, 162, 163, 164, 165, 166, 167, 168, 169, 170, 171, 172, and 173 respectively).

II. TESTING REQUIREMENTS.

No additional testing requirements exist except as provided in other sections of this permit including Section B (Title V General Requirements).

**SECTION D. Source Level Requirements****III. MONITORING REQUIREMENTS.****# 005 [25 Pa. Code §127.441]****Operating permit terms and conditions.**

[Additional authority for this permit condition is derived from 25 Pa. Code § 129.100]

The permittee shall monitor the volume of fuel used or the hours of operation to determine the fuel usage for these sources on a monthly basis.

IV. RECORDKEEPING REQUIREMENTS.**# 006 [25 Pa. Code §127.441]****Operating permit terms and conditions.**

[Additional authority for this permit condition is derived from 25 Pa. Code § 129.100]

(a) The permittee shall record the volume of fuel used or the hours of operation to determine fuel usage for these sources on a monthly basis and on a 12-month rolling basis.

(b) The permittee shall record the NO_x emissions from this source on a monthly basis and on a 12-month rolling basis.

V. REPORTING REQUIREMENTS.

No additional reporting requirements exist except as provided in other sections of this permit including Section B (Title V General Requirements).

VI. WORK PRACTICE REQUIREMENTS.

No additional work practice requirements exist except as provided in other sections of this permit including Section B (Title V General Requirements).

VII. ADDITIONAL REQUIREMENTS.**# 007 [25 Pa. Code §127.441]****Operating permit terms and conditions.**

This source group (15 Soaking Pits - Source ID: 151) consists of the following individual units: Fifteen 30-MMBTU/hr Soaking Pits No(s). 35, 36, 37, 38, 39, 40, 41, 42, 43, 44, 45, 46, 47, 48, 49. (Source ID(s): 159, 160, 161, 162, 163, 164, 165, 166, 167, 168, 169, 170, 171, 172, 173, respectively.)

***** Permit Shield in Effect. *****

**SECTION D. Source Level Requirements**

Source ID: 174

Source Name: GREEN ANNEAL GRIT BLASTER & BAGHOUSE

Source Capacity/Throughput: 25.000 Tons/HR STEEL PLATES

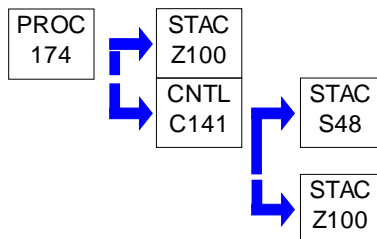
**I. RESTRICTIONS.****Emission Restriction(s).**

001 [25 Pa. Code §127.441]

Operating permit terms and conditions.

[Additional authority for this permit condition is also derived from 25 Pa. Code § 127.512(h)]

The permittee shall ensure that the total controlled particulate matter emissions from the Green Anneal Grit Blast operation (Source ID: 174) shall be limited to 3.69 pounds per hour and 16.16 tons per year, on a twelve (12) month rolling basis.

[Compliance with this streamlined condition also assures compliance with 25 Pa. Code § 123.13]

II. TESTING REQUIREMENTS.

No additional testing requirements exist except as provided in other sections of this permit including Section B (Title V General Requirements).

III. MONITORING REQUIREMENTS.

002 [25 Pa. Code §127.441]

Operating permit terms and conditions.

The permittee shall monitor the hours of operation for the Green Anneal Grit Blaster (Source ID: 174) on a monthly basis.

IV. RECORDKEEPING REQUIREMENTS.

003 [25 Pa. Code §127.441]

Operating permit terms and conditions.

(a) The permittee shall maintain records of the hours of operation for the Green Anneal Grit Blast operation (Source ID: 174) on a monthly and twelve (12) month rolling basis.

(b) The permittee shall calculate and record the particulate matter emissions from the Green Anneal Grit Blast operation (Source ID: 174) on a monthly and twelve (12) month rolling basis, to demonstrate compliance with the annual emission rate for this source.

V. REPORTING REQUIREMENTS.

No additional reporting requirements exist except as provided in other sections of this permit including Section B (Title V General Requirements).

VI. WORK PRACTICE REQUIREMENTS.

004 [25 Pa. Code §127.441]

Operating permit terms and conditions.

The permittee shall ensure that the emissions from Green Anneal Grit Blaster (Source ID: 174) operations are exhausted to

**SECTION D. Source Level Requirements**

the Camfil-Farr dust collector, model Tenkay GS-48 or equivalent (Source ID: C141).

VII. ADDITIONAL REQUIREMENTS.

No additional requirements exist except as provided in other sections of this permit including Section B (Title V General Requirements).

***** Permit Shield in Effect. *****

**SECTION D. Source Level Requirements**

Source ID: 176

Source Name: VERT.BLAST CONT.FIN.& BAGHOUSE

Source Capacity/Throughput:

35.000 Tons/HR

STEEL PLATES

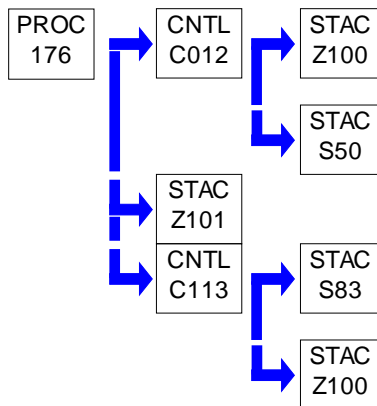
**I. RESTRICTIONS.****Emission Restriction(s).****# 001 [25 Pa. Code §127.441]****Operating permit terms and conditions.**

[Additional authority for this permit condition is also derived from 25 Pa. Code § 127.512(h)]

The permittee shall ensure that the total controlled particulate matter emissions from the Vertical Grit Blaster - Continuous Finishing Building (Source ID: 176) shall be limited to 1.09 pounds per hour and 4.09 tons per year, as a twelve (12) month rolling sum.

[Compliance with this streamlined condition also assures compliance with 25 Pa. Code § 123.13]

Operation Hours Restriction(s).**# 002 [25 Pa. Code §127.441]****Operating permit terms and conditions.**

[Additional authority for this permit condition is also derived from 25 Pa. Code § 127.512(h)]

The permittee shall limit the hours of operation of the Vertical Grit Blaster - Continuous Finishing Building (Source ID: 176) to 7,500 hours per year, as a twelve (12) month rolling sum.

II. TESTING REQUIREMENTS.

No additional testing requirements exist except as provided in other sections of this permit including Section B (Title V General Requirements).

III. MONITORING REQUIREMENTS.**# 003 [25 Pa. Code §127.441]****Operating permit terms and conditions.**

The permittee shall monitor the hours of operation for the Vertical Grit Blaster - Continuous Finishing Building (Source ID: 176) on a monthly basis.

IV. RECORDKEEPING REQUIREMENTS.**# 004 [25 Pa. Code §127.441]****Operating permit terms and conditions.**

The permittee shall maintain monthly and twelve (12) month rolling total records of the hours of operation for the Vertical Grit

**SECTION D. Source Level Requirements**

Blaster - Continuous Finishing Building (Source ID: 176).

005 [25 Pa. Code §127.441]**Operating permit terms and conditions.**

The permittee shall calculate and record emissions of particulate matter from the Vertical Grit Blaster - Continuous Finishing Building (Source ID: 176) on a monthly basis, and as a twelve (12) month rolling sum, to demonstrate compliance to the annual emission rates for this source.

V. REPORTING REQUIREMENTS.

No additional reporting requirements exist except as provided in other sections of this permit including Section B (Title V General Requirements).

VI. WORK PRACTICE REQUIREMENTS.**# 006 [25 Pa. Code §127.441]****Operating permit terms and conditions.**

The permittee shall ensure that the particulate matter emissions from the Vertical Grit Blaster - Continuous Finishing Building (Source ID: 176) shall be controlled by either the Pangborn Baghouse (Source ID: C012, Model # 195-HP-1015-TS) or the Farr Baghouse (Source ID: C113, Model # 32-D).

VII. ADDITIONAL REQUIREMENTS.**# 007 [25 Pa. Code §127.441]****Operating permit terms and conditions.**

The permittee shall ensure that dampers are in the supply ducts to Pangborn Baghouse (Source ID: C012) and the Farr Baghouse (Source ID: C113) which permit the operation of either the Vertical Grit Blaster - Continuous Finishing Building (Source ID: 176) or the Horizontal Grit Blaster Machine (Source ID: 258) with either control device. If both grit blast machines are operated simultaneously, the permittee shall ensure that both baghouses shall be utilized.

***** Permit Shield in Effect. *****

**SECTION D. Source Level Requirements**

Source ID: 181

Source Name: SOUTH STEEL YARD & BAGHOUSE

Source Capacity/Throughput: 200.000 Tons/HR STEEL INGOTS

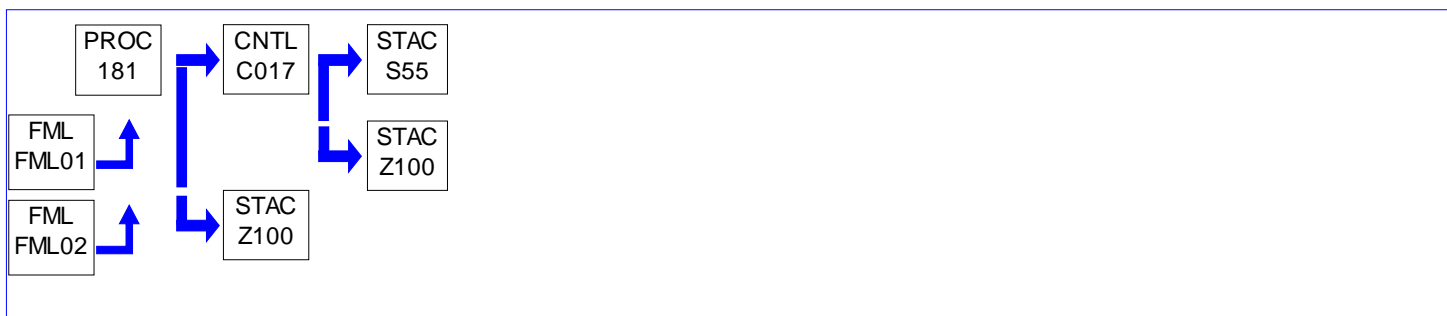
**I. RESTRICTIONS.****Emission Restriction(s).**

001 [25 Pa. Code §123.13]

Processes

See applicable particulate matter restriction for this source under associated control device (Source ID: C017).

II. TESTING REQUIREMENTS.

No additional testing requirements exist except as provided in other sections of this permit including Section B (Title V General Requirements).

III. MONITORING REQUIREMENTS.

002 [25 Pa. Code §127.441]

Operating permit terms and conditions.

The permittee shall monitor the hours of operation or the steel throughput from the South Steel Yard (Source ID: 181) on a monthly basis.

IV. RECORDKEEPING REQUIREMENTS.

003 [25 Pa. Code §127.441]

Operating permit terms and conditions.

The permittee shall maintain records of the hours of operation or the steel throughput from the South Steel Yard (Source ID: 181) on a monthly basis.

V. REPORTING REQUIREMENTS.

No additional reporting requirements exist except as provided in other sections of this permit including Section B (Title V General Requirements).

VI. WORK PRACTICE REQUIREMENTS.

No additional work practice requirements exist except as provided in other sections of this permit including Section B (Title V General Requirements).

VII. ADDITIONAL REQUIREMENTS.

No additional requirements exist except as provided in other sections of this permit including Section B (Title V General Requirements).

***** Permit Shield in Effect. *****

**SECTION D. Source Level Requirements**

Source ID: 182

Source Name: ACA POWDER CUTTING & BAGHOUSE

Source Capacity/Throughput:

50.000 Tons/HR

STEEL SLABS

**I. RESTRICTIONS.****Emission Restriction(s).****# 001 [25 Pa. Code §127.441]****Operating permit terms and conditions.**

[Additional authority for this permit condition is also derived from 25 Pa. Code § 127.512(h)]

(a) The total controlled particulate matter (PM) emissions from the ACA Powder Cutting operation shall be limited to 0.72 lb/hr and 3.13 tons per 12-month rolling period.

(b) Total controlled emissions of the following HAPs shall be limited to 0.233 tons per 12-month rolling sum:

- (1) Chromium
- (2) Manganese
- (3) Nickel

(c) Compliance to the HAP limit shall be demonstrated by complying with the PM emission limits applicable to this source.

002 [25 Pa. Code §127.441]**Operating permit terms and conditions.**

[Additional authority for this permit condition is also derived from 25 Pa. Code §§ 127.1 and 127.512(h)]

The emissions of PM from the dust collector shall not exceed 0.01 grains per dry standard cubic foot.

[Compliance with this streamlined condition also assures compliance with 25 Pa. Code § 123.13]

II. TESTING REQUIREMENTS.

No additional testing requirements exist except as provided in other sections of this permit including Section B (Title V General Requirements).

III. MONITORING REQUIREMENTS.**# 003 [25 Pa. Code §127.441]****Operating permit terms and conditions.**

(a) The dust collector shall be equipped with a pressure drop gauge to measure the pressure drop across the dust collector filters, in inches water gauge (w.g.).

(b) The pressure drop across the dust collector filters shall be monitored on a weekly basis, when the dust collector is operating.

004 [25 Pa. Code §127.441]

**SECTION D. Source Level Requirements****Operating permit terms and conditions.**

The permittee shall monitor the hours of operation of the ACA Powder Cutting operation on a monthly basis.

005 [25 Pa. Code §127.441]**Operating permit terms and conditions.**

(a) Natural Gas usage shall be monitored per Title V Operating Permit 15-00010, under Source ID: 183, Misc. Procs. & Gas Use (10).

(b) Propane usage shall be monitored per Condition #020, under the Site Level Requirements of Title V Operating Permit 15-00010, and Condition #003, under Section D of the same Title V Operating Permit, under Source ID: 044, Propane Vaporizer.

IV. RECORDKEEPING REQUIREMENTS.**# 006 [25 Pa. Code §127.441]****Operating permit terms and conditions.**

(a) The pressure drop across the dust collector shall be recorded at a minimum on a weekly basis, when the dust collector is operating.

(b) If pressure drop readings exceed the pressure drop range specified for this dust collector, the facility shall document the reason for operating outside the range, and the steps taken to correct it.

007 [25 Pa. Code §127.441]**Operating permit terms and conditions.**

(a) The permittee shall record the hours of operation of the ACA Powder Cutting operation on a monthly basis, and as a 12-month rolling.

(b) The permittee shall calculate and record emissions of PM, Chromium, Manganese, and Nickel from the ACA Powder Cutting operation on a monthly basis, and as a 12-month rolling sum.

008 [25 Pa. Code §127.441]**Operating permit terms and conditions.**

A log shall be maintained to document maintenance performed on the dust collector, as well as noting when bags are replaced, and how many bags were replaced.

009 [25 Pa. Code §127.441]**Operating permit terms and conditions.**

(a) Natural Gas usage shall be recorded per Title V Operating Permit 15-00010, under Source ID: 183, Misc. Procs. & Gas Use (10).

(b) Propane usage shall be recorded per Condition #020, under the Site Level Requirements of Title V Operating Permit 15-00010, and Condition #004, under Section D of the same Title V Operating Permit, under Source ID: 044, Propane Vaporizer.

V. REPORTING REQUIREMENTS.

No additional reporting requirements exist except as provided in other sections of this permit including Section B (Title V General Requirements).

VI. WORK PRACTICE REQUIREMENTS.**# 010 [25 Pa. Code §127.441]****Operating permit terms and conditions.**

(a) The pressure drop across the dust collector shall be maintained within a nominal pressure drop range of 1.0 to 10.0 inches w.g.

**SECTION D. Source Level Requirements**

(b) If the pressure drop exceeds the above nominal pressure drop range, the facility shall inspect the dust collector to determine the reason for the exceedance and take the appropriate steps to ensure that there are no more exceedances.

011 [25 Pa. Code §127.441]

Operating permit terms and conditions.

Spare bags shall be available on site at all times for immediate replacement of worn or torn dust collector bags.

012 [25 Pa. Code §127.441]

Operating permit terms and conditions.

The ACA Powder Cutting & Baghouse shall be operated such that no visible emissions escape from the source or the control device.

VII. ADDITIONAL REQUIREMENTS.

013 [25 Pa. Code §127.441]

Operating permit terms and conditions.

This source shall be ducted to a custom made GE Energy/BHA Dust Collector (Source ID: C182).

***** Permit Shield in Effect. *****

**SECTION D. Source Level Requirements**

Source ID: 183

Source Name: MISC PROCS & GAS USE (10)

Source Capacity/Throughput: 259.000 MCF/HR Natural Gas

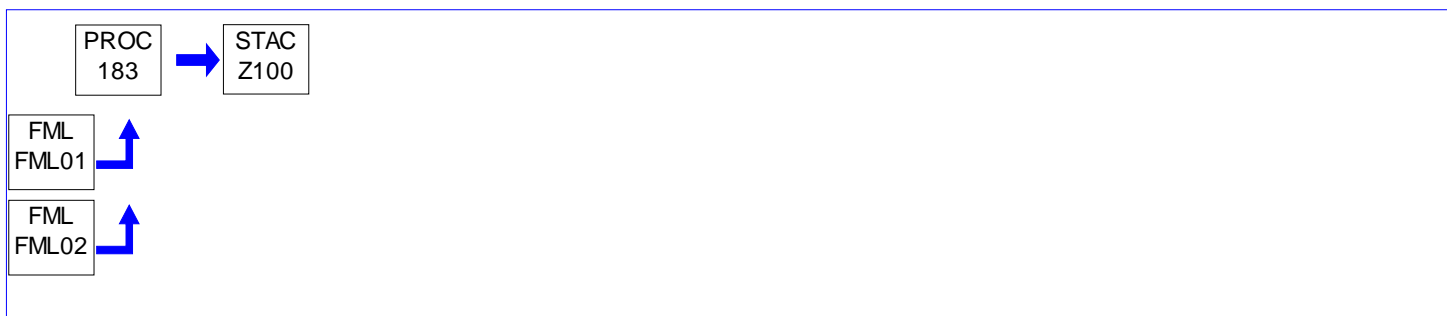
**I. RESTRICTIONS.****Emission Restriction(s).**

001 [25 Pa. Code §123.13]

Processes

The permittee may not permit the emission into the outdoor atmosphere of filterable particulate matter from a process, as measured by Method 5 of 40 CFR 60, Appendix A (or an equivalent method approved by the Department), in a manner that the concentration of particulate matter in the effluent gas exceeds 0.04 grains per dry standard cubic foot.

002 [25 Pa. Code §123.21]

General

No person may permit the emission into the outdoor atmosphere of sulfur oxides from a process in a manner that the concentration of the sulfur oxides, expressed as SO₂, in the effluent gas exceeds 500 ppmvd.

003 [25 Pa. Code §123.22]

Combustion units

No person may permit the emission into the outdoor atmosphere of sulfur oxides (SO_x), expressed as SO₂, from any combustion unit, in the Southeast Air Basin, in excess of 1.2 pounds per million BTU of heat input, pursuant to 25 Pa. Code § 123.22(e)(1).

II. TESTING REQUIREMENTS.

No additional testing requirements exist except as provided in other sections of this permit including Section B (Title V General Requirements).

III. MONITORING REQUIREMENTS.

004 [25 Pa. Code §127.441]

Operating permit terms and conditions.

The permittee shall monitor the fuel usage of the miscellaneous processes associated with this source group (Misc. Procs. & Gas Use (10) - Source ID: 183) by deducting all separately metered fuel uses from the total monthly fuel usage data.

IV. RECORDKEEPING REQUIREMENTS.

005 [25 Pa. Code §127.441]

Operating permit terms and conditions.

The permittee shall maintain records of the fuel usage data and calculations for all miscellaneous processes associated with this source group (Misc. Procs. & Gas Use (10) - Source ID: 183).

V. REPORTING REQUIREMENTS.

No additional reporting requirements exist except as provided in other sections of this permit including Section B (Title V General Requirements).

**SECTION D. Source Level Requirements****VI. WORK PRACTICE REQUIREMENTS.****# 006 [25 Pa. Code §127.441]****Operating permit terms and conditions.**

[Additional authority for this permit condition is derived from 25 Pa. Code § 129.97(c)]

- (a) The permittee shall maintain and operate the ICA Preheater (Lg) and the ICA Preheater (Sm) in accordance with the manufacturer's specifications and with good operating practices.
- (b) If the manufacturer's specifications are unavailable, the permittee shall ensure that the ICA Ladle Preheater (Lg) and the ICA Ladle Preheater (Sm) are maintained and operated in a manner consistent with safety and good air pollution control practices for minimizing emissions.

VII. ADDITIONAL REQUIREMENTS.**# 007 [25 Pa. Code §127.441]****Operating permit terms and conditions.**

(a) Source ID 183 addresses fuel usage and emissions from the following insignificant sources:

- (1) Space Heaters (1.0 MMBtu/hr or less, each)
- (2) Gas Cutting (1.0 MMBtu/hr or less, each)
- (3) ICA Torch Cutting Operation (1.0 MMBtu/hr or less, each)
- (4) ACA Cutting Operation (1.0 MMBtu/hr or less, each)
- (5) ACA Preheaters (1.0 MMBtu/hr or less, each)
- (6) South Steel Yard Cutting Operation (1.0 MMBtu/hr or less, each)
- (7) Tundish Heater (1.0 MMBtu/hr or less, each)
- (8) Hot Water Heaters (1.0 MMBtu/hr or less, each)
- (9) Scarfing - Hand Torch (1.0 MMBtu/hr or less, each)
- (10) Line Heaters (1.0 MMBtu/hr or less, each)
- (11) ICA Preheater - Large (9.5 MMBtu/hr)
- (12) ICA Preheater - Small (3.8 MMBtu/hr)
- (13) Three (3) Emergency Generators (1.0 MMBtu/hr or less, each)

(b) Where sources listed above in paragraph (a) above are followed by "1.0 MMBtu/hr or less, each", it is only intended to identify existing sources where fuel is tracked together under Source ID 183. The permittee shall provide any updates or changes to this list of sources with its renewal application.

***** Permit Shield in Effect. *****

**SECTION D. Source Level Requirements**

Source ID: 190

Source Name: BICKLEY FURNACE

Source Capacity/Throughput:

6.000 MCF/HR

Natural Gas

**I. RESTRICTIONS.****Emission Restriction(s).**

001 [25 Pa. Code §123.13]

Processes

The permittee may not permit the emission into the outdoor atmosphere of filterable particulate matter, as measured by Method 5 of 40 CFR 60, Appendix A (or an equivalent method approved by the Department), in a manner that the concentration of particulate matter in the effluent gas exceeds 0.04 grains per dry standard cubic foot.

002 [25 Pa. Code §123.21]

General

No person may permit the emission into the outdoor atmosphere of sulfur oxides from this source in a manner that the concentration of the sulfur oxides, expressed as SO₂, in the effluent gas exceeds 500 ppmvd.

II. TESTING REQUIREMENTS.

No additional testing requirements exist except as provided in other sections of this permit including Section B (Title V General Requirements).

III. MONITORING REQUIREMENTS.

003 [25 Pa. Code §127.441]

Operating permit terms and conditions.

The permittee shall monitor the fuel usage, or the hours of operation of this source on a monthly basis.

IV. RECORDKEEPING REQUIREMENTS.

004 [25 Pa. Code §127.441]

Operating permit terms and conditions.

The permittee shall record the fuel usage, or the hours of operation of this source on a monthly basis.

V. REPORTING REQUIREMENTS.

No additional reporting requirements exist except as provided in other sections of this permit including Section B (Title V General Requirements).

VI. WORK PRACTICE REQUIREMENTS.

005 [25 Pa. Code §127.441]

Operating permit terms and conditions.

[Additional authority for this permit condition is derived from 25 Pa. Code § 129.97(c)]

(a) The permittee shall maintain and operate this source in accordance with the manufacturer's specifications and with

**SECTION D. Source Level Requirements**

good operating practices.

(b) In instances where the manufacturer's specification information is no longer available or applicable, the permittee shall ensure that the source shall be maintained and operated in a manner consistent with safety and good air pollution control practices for minimizing emissions.

VII. ADDITIONAL REQUIREMENTS.

No additional requirements exist except as provided in other sections of this permit including Section B (Title V General Requirements).

***** Permit Shield in Effect. *****

**SECTION D. Source Level Requirements**

Source ID: 192

Source Name: 140M SAUDER FURNACE

Source Capacity/Throughput:

8.000 MCF/HR

Natural Gas

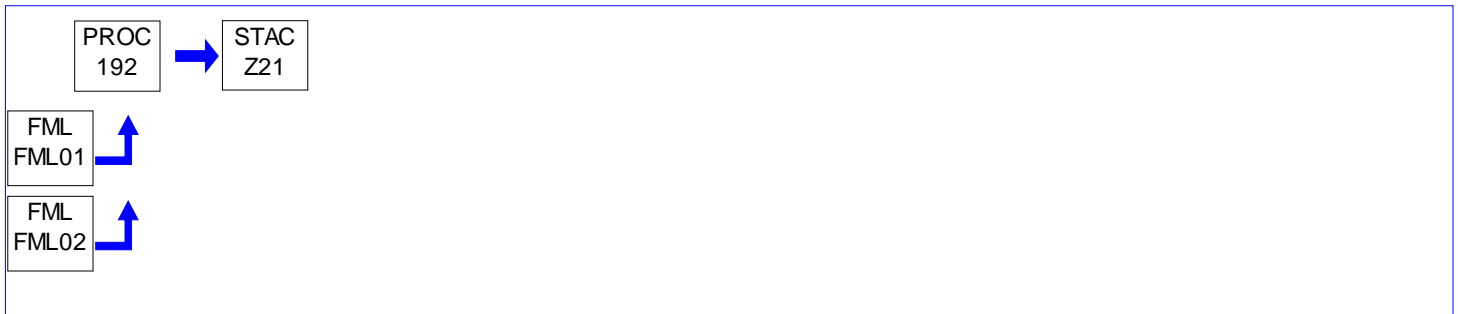
**I. RESTRICTIONS.****Emission Restriction(s).**

001 [25 Pa. Code §123.13]

Processes

The permittee may not permit the emission into the outdoor atmosphere of filterable particulate matter, as measured by Method 5 of 40 CFR 60, Appendix A (or an equivalent method approved by the Department), in a manner that the concentration of particulate matter in the effluent gas exceeds 0.04 grains per dry standard cubic foot.

002 [25 Pa. Code §123.21]

General

No person may permit the emission into the outdoor atmosphere of sulfur oxides from this source in a manner that the concentration of the sulfur oxides, expressed as SO₂, in the effluent gas exceeds 500 ppmvd.

II. TESTING REQUIREMENTS.

No additional testing requirements exist except as provided in other sections of this permit including Section B (Title V General Requirements).

III. MONITORING REQUIREMENTS.

003 [25 Pa. Code §127.441]

Operating permit terms and conditions.

The permittee shall monitor the fuel usage, or the hours of operation of this source on a monthly basis.

IV. RECORDKEEPING REQUIREMENTS.

004 [25 Pa. Code §127.441]

Operating permit terms and conditions.

The permittee shall record the fuel usage, or the hours of operation of this source on a monthly basis.

V. REPORTING REQUIREMENTS.

No additional reporting requirements exist except as provided in other sections of this permit including Section B (Title V General Requirements).

VI. WORK PRACTICE REQUIREMENTS.

005 [25 Pa. Code §127.441]

Operating permit terms and conditions.

[Additional authority for this permit condition is derived from 25 Pa. Code § 129.97(c)]

(a) The permittee shall maintain and operate this source in accordance with the manufacturer's specifications and with

**SECTION D. Source Level Requirements**

good operating practices.

(b) In instances where the manufacturer's specification information is no longer available or applicable, the permittee shall ensure that the source shall be maintained and operated in a manner consistent with safety and good air pollution control practices for minimizing emissions.

VII. ADDITIONAL REQUIREMENTS.

No additional requirements exist except as provided in other sections of this permit including Section B (Title V General Requirements).

***** Permit Shield in Effect. *****

**SECTION D. Source Level Requirements**

Source ID: 207

Source Name: ICA HOT TOP CUT.STATION & BAGHOUSE

Source Capacity/Throughput: 75.000 Tons/HR INGOTS & SLABS

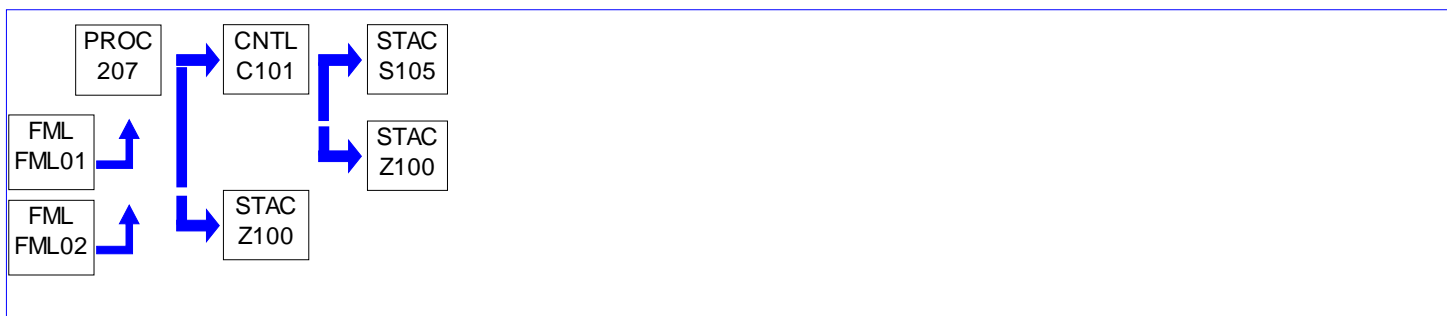
**I. RESTRICTIONS.****Emission Restriction(s).**

001 [25 Pa. Code §123.13]

Processes

See applicable particulate matter restrictions for this source under associated control device - Source ID: C101.

II. TESTING REQUIREMENTS.

No additional testing requirements exist except as provided in other sections of this permit including Section B (Title V General Requirements).

III. MONITORING REQUIREMENTS.

No additional monitoring requirements exist except as provided in other sections of this permit including Section B (Title V General Requirements).

IV. RECORDKEEPING REQUIREMENTS.

No additional record keeping requirements exist except as provided in other sections of this permit including Section B (Title V General Requirements).

V. REPORTING REQUIREMENTS.

No additional reporting requirements exist except as provided in other sections of this permit including Section B (Title V General Requirements).

VI. WORK PRACTICE REQUIREMENTS.

No additional work practice requirements exist except as provided in other sections of this permit including Section B (Title V General Requirements).

VII. ADDITIONAL REQUIREMENTS.

002 [25 Pa. Code §127.441]

Operating permit terms and conditions.

The permittee shall ensure that particulate matter emissions from the ICA Hot Top Cutting Station (Source ID: 207) are exhausted to the Fuller baghouse (Source ID: C101).

***** Permit Shield in Effect. *****

**SECTION D. Source Level Requirements**

Source ID: 211

Source Name: PARTS WASHERS

Source Capacity/Throughput: 2,700.000 Lbs/HR SOLVENT

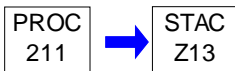
**I. RESTRICTIONS.**

No additional requirements exist except as provided in other sections of this permit including Section B (Title V General Requirements).

II. TESTING REQUIREMENTS.**# 001 [25 Pa. Code §127.441]****Operating permit terms and conditions.**

(a) If the permittee does not have a Safety Data Sheet (SDS) or Certified Product Data Sheet (CPDS) that contains the VOC and HAP content, by weight, for solvents being used in the cold cleaning machines, then the permittee shall perform testing to determine the VOC and HAP content.

(b) The VOC and HAP content shall be determined using a Department approved test method(s).

III. MONITORING REQUIREMENTS.**# 002 [25 Pa. Code §127.441]****Operating permit terms and conditions.**

The permittee shall monitor the solvent usage for all the parts degreasers at the facility on a material balance basis.

IV. RECORDKEEPING REQUIREMENTS.**# 003 [25 Pa. Code §127.441]****Operating permit terms and conditions.**

The permittee shall maintain records of solvent usage for all the parts degreasers at the facility on a material balance basis. The records shall contain sufficient information to track VOC and HAP emissions on a monthly basis.

V. REPORTING REQUIREMENTS.

No additional reporting requirements exist except as provided in other sections of this permit including Section B (Title V General Requirements).

VI. WORK PRACTICE REQUIREMENTS.**# 004 [25 Pa. Code §129.63]****Degreasing operations**

For each parts washer that use 2 gallons or more of solvents containing greater than 5% VOC content by weight for the cleaning of metal parts:

(a) The parts washer shall have a freeboard ratio of 0.50 or greater.

(b) The parts washer shall have a permanent, conspicuous label summarizing the following operating requirements:

(1) Waste solvent shall be collected and stored in closed containers. The closed containers may contain a device that allows pressure relief, but does not allow liquid solvent to drain from the container.

(2) Flushing of parts using a flexible hose or other flushing device shall be performed only within the cold cleaning machine. The solvent spray shall be a solid fluid stream, not an atomized or shower spray.

**SECTION D. Source Level Requirements**

- (3) Sponges, fabric, wood, leather, paper products and other absorbent materials may not be cleaned in the cold cleaning machine.
 - (4) Air agitated solvent baths may not be used.
 - (5) Spills during solvent transfer and use of the cold cleaning machine shall be cleaned up immediately.
 - (6) Cleaned parts should be drained at least 15 seconds or until dripping ceases, whichever is longer. Parts having cavities or blind holes shall be tipped or rotated while the part is draining. During the draining, tipping or rotating, the parts should be positioned so that solvent drains directly back to the cold cleaning machine.
 - (7) When a pump-agitated solvent bath is used, the agitator should be operated to produce a rolling motion of the solvent with no observable splashing of the solvent against the tank walls or the parts being cleaned.
 - (8) Work area fans should be located and positioned so that they do not blow across the opening of the degreaser unit.
- (c) The parts washer shall be equipped with a cover that shall be closed at all times except during cleaning of parts or the addition or removal of solvent. For remote reservoir cold cleaning machines which drain directly into the solvent storage reservoir, a perforated drain with a diameter of not more than 6 inches shall constitute an acceptable cover.
- (d) The permittee may not use any solvent in a parts washer with a vapor pressure of 1.0 millimeter of mercury (mm Hg) or greater and containing greater than 5% VOC by weight, measured at 20°C (68°F) containing VOCs.
- (e) Solvents purchased by the permittee shall contain the following information:
- (1) The name and address of the solvent supplier.
 - (2) The type of solvent including the product or vendor identification number.
 - (3) The vapor pressure of the solvent measured in mm hg at 20°C (68°F).
- (f) The requirements of paragraph (d) do not apply to the following, pursuant to 25 Pa. Code § 129.63(a)(7):
- (1) Cold cleaning machines used in extreme cleaning service;
 - (2) Cold cleaning machines for which the permittee demonstrates, and the Department approves in writing, that compliance with paragraph (d) would result in unsafe operating conditions; and,
 - (3) Immersion cold cleaning machines with a freeboard ratio equal to or greater than 0.75.

VII. ADDITIONAL REQUIREMENTS.

No additional requirements exist except as provided in other sections of this permit including Section B (Title V General Requirements).

***** Permit Shield in Effect. *****

**SECTION D. Source Level Requirements**

Source ID: 226

Source Name: 12,000 GAL UNDERGROUND GAS STORAGE TANK

Source Capacity/Throughput: 12,000.000 Gal/HR GASOLINE

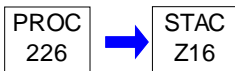
**I. RESTRICTIONS.**

No additional requirements exist except as provided in other sections of this permit including Section B (Title V General Requirements).

II. TESTING REQUIREMENTS.

No additional testing requirements exist except as provided in other sections of this permit including Section B (Title V General Requirements).

III. MONITORING REQUIREMENTS.**# 001 [25 Pa. Code §127.441]****Operating permit terms and conditions.**

The permittee shall monitor the throughputs for this tank on an on-going basis.

IV. RECORDKEEPING REQUIREMENTS.**# 002 [25 Pa. Code §127.441]****Operating permit terms and conditions.**

[Additional authority for this permit condition is also derived from 40 CFR §§ 63.11111, 63.11115(b), 63.11116(b), and 63.11125(d)]

(a) The permittee shall maintain files of all information (including all reports and notifications) required under 40 CFR Part 63, Subpart CCCCCC, recorded in a form suitable and readily available for expeditious inspection and review. The files shall be retained for at least 5 years following the date of each occurrence, measurement, maintenance, corrective action, report, or record. At a minimum, the most recent 2 years of data shall be retained on site. The remaining 3 years of data may be retained off site. Such files may be maintained on microfilm, on a computer, or computer floppy disks, on magnetic tape disks, or on microfiche.

(b) The permittee shall document and maintain records for the following:

- (1) Monthly gasoline throughput;
- (2) The occurrence and duration of each malfunction of operation (i.e., process equipment) or the air pollution control and monitoring equipment;
- (3) Actions taken during periods of malfunction to minimize emissions in accordance with 40 CFR § 63.11115(a), including corrective actions to restore malfunctioning process and air pollution control and monitoring equipment to its normal or usual manner of operation; and,
- (4) All required maintenance performed on the air pollution control and monitoring equipment.

003 [25 Pa. Code §127.441]**Operating permit terms and conditions.**

The permittee shall maintain records of throughputs for this tank in order to calculate emissions of VOCs and HAPs.

**SECTION D. Source Level Requirements****V. REPORTING REQUIREMENTS.**

No additional reporting requirements exist except as provided in other sections of this permit including Section B (Title V General Requirements).

VI. WORK PRACTICE REQUIREMENTS.**# 004 [25 Pa. Code §127.441]****Operating permit terms and conditions.**

[Additional authority for this permit condition is also derived from 40 CFR § 63.11115]

The permittee must, at all times, operate and maintain any affected source, including associated air pollution control equipment and monitoring equipment, in a manner consistent with safety and good air pollution control practices for minimizing emissions.

005 [25 Pa. Code §129.61]**Small gasoline storage tank control (Stage 1 control)**

(a) The permittee may not transfer gasoline from a delivery vessel into a stationary storage tank unless the displaced vapors from the storage tank are transferred to the dispensing delivery tank through a vapor tight return line and unless the receiving tank is equipped with a submerged fill pipe which extends from the filling orifice to within six (6) inches of the bottom of the tank.

(b) The dispensing delivery tank shall remain vapor tight at all times. The delivery tank may be opened after the vapors are disposed of in accordance with 25 Pa. Code §§ 129.59 or 129.60(c).

006 [40 CFR Part 63 NESHAPS for Source Categories §40 CFR 63.11116]**Subpart CCCCCC - National Emission Standards for Hazardous Air Pollutants for Gasoline Dispensing Facilities Requirements for facilities with monthly throughput of less than 10,000 gallons of gasoline.**

(a) The monthly throughput of gasoline shall remain below 10,000 gallons per month.

(b) The permittee shall not allow gasoline to be handled in a manner that would result in vapor releases to the atmosphere for extended periods of time. Measures to be taken include, but are not limited to, the following:

- (1) Minimize gasoline spills;
- (2) Clean up spills as expeditiously as practicable;
- (3) Cover all open gasoline containers and all gasoline storage tank fill-pipes with a gasketed seal when not in use; and,
- (4) Minimize gasoline sent to open waste collection systems that collect and transport gasoline to reclamation and recycling devices such as oil/water separators.

(c) Portable gasoline containers that meet the requirements of 40 CFR Part 59, Subpart F, are considered acceptable for compliance with paragraph (b)(3) of this condition.

VII. ADDITIONAL REQUIREMENTS.**# 007 [25 Pa. Code §127.441]****Operating permit terms and conditions.**

[Additional authority for this permit condition is also derived from 40 CFR §§ 63.11111 and 63.11112]

The following are subject to the requirements of 40 CFR Part 63, Subpart CCCCCC:

(a) Each gasoline dispensing facility (GDF) located at an area source; the affected source includes each gasoline cargo tank during the delivery of product to a GDF and also includes each storage tank.

(b) The emission sources to which this subpart applies are gasoline storage tanks and associated equipment components in vapor or liquid gasoline service at new, reconstructed, or existing GDF that meet the criteria specified in 40 CFR § 63.11111; pressure/vacuum vents on gasoline storage tanks and the equipment necessary to unload product from cargo tanks into the storage tanks at GDF are covered emission sources. The equipment used for the refueling of motor vehicles is not covered by Subpart CCCCCC.



SECTION D. Source Level Requirements

***** Permit Shield in Effect. *****

**SECTION D. Source Level Requirements**

Source ID: 228

Source Name: LADLE REFINER - FCE

Source Capacity/Throughput: 177.000 Tons/HR CARBON/ALLOY/STAINLESS STE

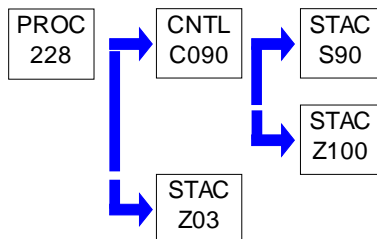
**I. RESTRICTIONS.****Emission Restriction(s).**

001 [25 Pa. Code §123.13]

Processes

See applicable particulate matter restrictions for this source under associated control device - Source ID: C090.

002 [25 Pa. Code §123.21]

General

The permittee may not permit the emission into the outdoor atmosphere of sulfur oxides from any source in a manner that the concentration of the sulfur oxides, expressed as SO₂, in the effluent gas exceeds 500 parts per million, by volume, dry basis.

Throughput Restriction(s).

003 [25 Pa. Code §127.441]

Operating permit terms and conditions.

[Additional authority for this permit condition is also derived from 25 Pa. Code § 127.512(h)]

The permittee shall ensure that the Ladle Refiner - FCE process (Source ID: 228) shall be limited to 1.55 million tons steel per year.

II. TESTING REQUIREMENTS.

No additional testing requirements exist except as provided in other sections of this permit including Section B (Title V General Requirements).

III. MONITORING REQUIREMENTS.

004 [25 Pa. Code §127.441]

Operating permit terms and conditions.

The permittee shall monitor the throughput of steel from the Ladle Refiner - FCE process (Source ID: 228) on a monthly basis.

IV. RECORDKEEPING REQUIREMENTS.

005 [25 Pa. Code §127.441]

Operating permit terms and conditions.

The permittee shall maintain monthly steel throughput records for the Ladle Refiner - FCE process (Source ID: 228).

V. REPORTING REQUIREMENTS.

No additional reporting requirements exist except as provided in other sections of this permit including Section B (Title V General Requirements).



SECTION D. Source Level Requirements

VI. WORK PRACTICE REQUIREMENTS.

No additional work practice requirements exist except as provided in other sections of this permit including Section B (Title V General Requirements).

VII. ADDITIONAL REQUIREMENTS.

No additional requirements exist except as provided in other sections of this permit including Section B (Title V General Requirements).

***** Permit Shield in Effect. *****

**SECTION D. Source Level Requirements**

Source ID: 229

Source Name: LADLE PRE-HEATER

Source Capacity/Throughput: 10.000 MMBTU/HR

9.709 MCF/HR Natural Gas

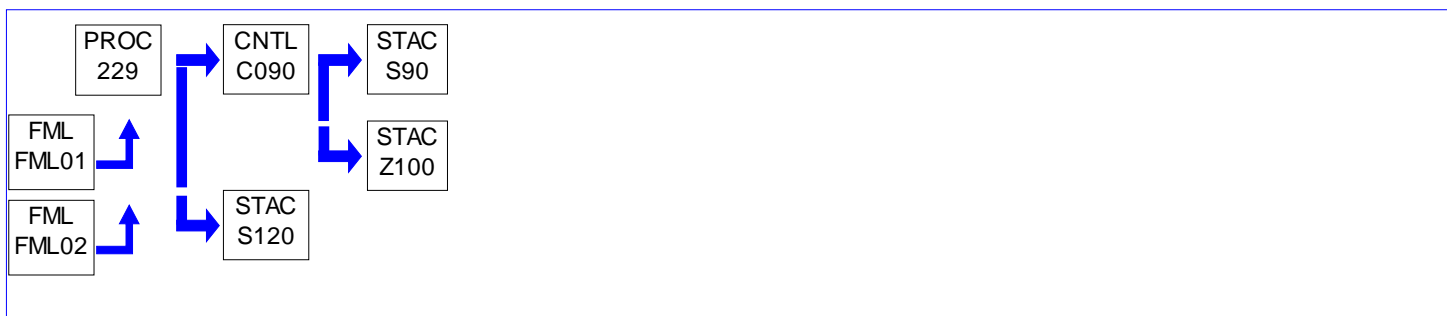
**I. RESTRICTIONS.****Emission Restriction(s).**

001 [25 Pa. Code §123.13]

Processes

See applicable particulate matter restrictions for this source under associated control device - Source ID: C090.

002 [25 Pa. Code §123.21]

General

The permittee may not permit the emission into the outdoor atmosphere of sulfur oxides from this source in a manner that the concentration of the sulfur oxides, expressed as SO₂, in the effluent gas exceeds 500 parts per million, by volume, dry basis.

II. TESTING REQUIREMENTS.

No additional testing requirements exist except as provided in other sections of this permit including Section B (Title V General Requirements).

III. MONITORING REQUIREMENTS.

003 [25 Pa. Code §127.441]

Operating permit terms and conditions.

The permittee shall monitor the amount of fuel used, or the hours of operation for this source on a monthly basis.

IV. RECORDKEEPING REQUIREMENTS.

004 [25 Pa. Code §127.441]

Operating permit terms and conditions.

The permittee shall record the amount of fuel used, or the hours of operation for this source on a monthly basis.

V. REPORTING REQUIREMENTS.

No additional reporting requirements exist except as provided in other sections of this permit including Section B (Title V General Requirements).

VI. WORK PRACTICE REQUIREMENTS.

005 [25 Pa. Code §127.441]

Operating permit terms and conditions.

[Additional authority for this permit condition is derived from 25 Pa. Code § 129.97(c)]

(a) The permittee shall maintain and operate this source in accordance with the manufacturer's specifications and with good operating practices.

**SECTION D. Source Level Requirements**

(b) In instances where the manufacturer's specification information is no longer available or applicable, the permittee shall ensure that the source shall be maintained and operated in a manner consistent with safety and good air pollution control practices for minimizing emissions.

VII. ADDITIONAL REQUIREMENTS.

006 [25 Pa. Code §127.441]

Operating permit terms and conditions.

The Ladle Pre-Heater (Source ID 229), consists of one (1) 10.0 MMBtu/hr unit.

***** Permit Shield in Effect. *****

**SECTION D. Source Level Requirements**

Source ID: 229A

Source Name: LADLE PRE-HEATER (4575-10-B)

Source Capacity/Throughput: 12.000 MMBTU/HR

11.650 MCF/HR Natural Gas

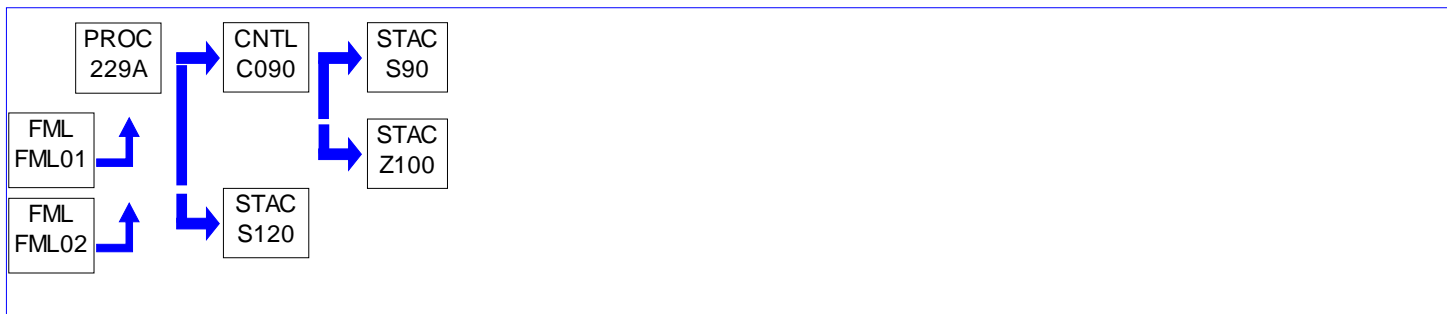
**I. RESTRICTIONS.****Emission Restriction(s).**

001 [25 Pa. Code §123.13]

Processes

See applicable particulate matter restrictions for this source under associated control device - Source ID: C090.

002 [25 Pa. Code §123.21]

General

The permittee may not permit the emission into the outdoor atmosphere of sulfur oxides from this source in a manner that the concentration of the sulfur oxides, expressed as SO₂, in the effluent gas exceeds 500 parts per million, by volume, dry basis.

003 [25 Pa. Code §127.441]

Operating permit terms and conditions.

[Additional authority for this permit condition is also derived from 25 Pa. Code §§ 127.1 and 127.512(h)]

This source shall comply with the following emission rates:

(a) Nitrogen Oxides (NO_x) -

- (1) 113.3 lb/MMcf of natural gas
- (2) 5.78 tons per 12-month rolling period

(b) Carbon Monoxide (CO) -

- (1) 84.0 lbs/MMcf of natural gas
- (2) 4.29 tons per 12-month rolling period

II. TESTING REQUIREMENTS.

No additional testing requirements exist except as provided in other sections of this permit including Section B (Title V General Requirements).

III. MONITORING REQUIREMENTS.

004 [25 Pa. Code §127.441]

Operating permit terms and conditions.

The permittee shall monitor the amount of fuel used, or the hours of operation for this source on a monthly basis.

**SECTION D. Source Level Requirements****IV. RECORDKEEPING REQUIREMENTS.****# 005 [25 Pa. Code §127.441]****Operating permit terms and conditions.**

- (a) The permittee shall maintain on site at all times documentation of tune-ups performed on this source.
- (b) The permittee shall maintain on site at all times the manufacturer's recommended tune-up requirements.

[Compliance with this streamlined condition also assures compliance with 25 Pa. Code § 129.97(c)(3)]

006 [25 Pa. Code §127.441]**Operating permit terms and conditions.**

- (a) The permittee shall record the amount of fuel used, or the hours of operation for this source on a monthly basis.
- (b) The permittee shall calculate and record emissions of NOx and CO on a monthly basis and as a 12-month rolling sum. Emissions of NOx and CO shall be calculated using the most current stack test results performed on one of the ladle preheaters covered under Source IDs 229A and 229B.

V. REPORTING REQUIREMENTS.

No additional reporting requirements exist except as provided in other sections of this permit including Section B (Title V General Requirements).

VI. WORK PRACTICE REQUIREMENTS.**# 007 [25 Pa. Code §127.441]****Operating permit terms and conditions.**

- (a) This source shall be tuned up annually, such that tune-ups occur no more than 14 months apart and no sooner than 10 months apart.
- (b) Tune-ups shall occur according to manufacturer specifications.

[Compliance with this streamlined condition also assures compliance with 25 Pa. Code § 129.97(c)(3)]

VII. ADDITIONAL REQUIREMENTS.**# 008 [25 Pa. Code §127.441]****Operating permit terms and conditions.**

This source, Ladle Pre-Heater (Source ID: 229A), is a 12.0 MMBtu/hr unit.

***** Permit Shield in Effect. *****

**SECTION D. Source Level Requirements**

Source ID: 229B

Source Name: LADLE PRE-HEATERS "B" AND "D"

Source Capacity/Throughput: 24.000 MMBTU/HR

23.300 MCF/HR Natural Gas

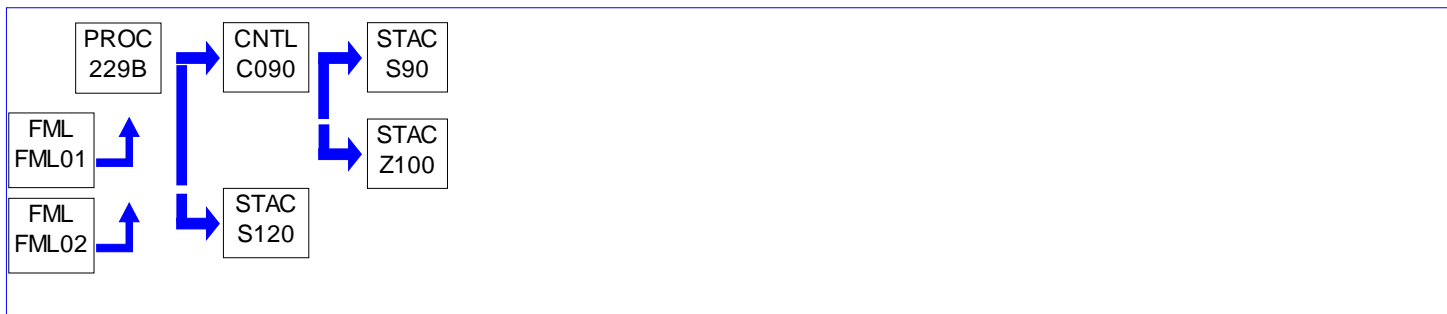
**I. RESTRICTIONS.****Emission Restriction(s).**

001 [25 Pa. Code §123.13]

Processes

See applicable particulate matter restrictions for this source under associated control device - Source ID: C090, as reflected under Title V Operating Permit No. 15-00010.

002 [25 Pa. Code §123.21]

General

The permittee may not permit the emission into the outdoor atmosphere of sulfur oxides from a source in a manner that the concentration of the sulfur oxides, expressed as SO₂, in the effluent gas exceeds 500 parts per million, by volume, dry basis.

003 [25 Pa. Code §127.441]

Operating permit terms and conditions.

[Additional authority for this permit condition is also derived from 25 Pa. Code § 127.1]

Each Ladle Pre-heater under Source ID 229B shall comply with the following emission rates:

(a) Nitrogen Oxides (NO_x) -

- (1) 113.3 lb/MMcf of natural gas
- (2) 5.78 tons per 12-month rolling period

(b) Carbon Monoxide (CO) -

- (1) 84.0 lbs/MMcf of natural gas
- (2) 4.29 tons per 12-month rolling period

II. TESTING REQUIREMENTS.

No additional testing requirements exist except as provided in other sections of this permit including Section B (Title V General Requirements).

III. MONITORING REQUIREMENTS.

004 [25 Pa. Code §127.441]

Operating permit terms and conditions.

The permittee shall monitor the amount of fuel used, or the hours of operation from each ladle preheater on a monthly basis.

**SECTION D. Source Level Requirements****IV. RECORDKEEPING REQUIREMENTS.****# 005 [25 Pa. Code §127.441]****Operating permit terms and conditions.**

- (a) The permittee shall record the amount of fuel used, or the hours of operation from each ladle preheater on a monthly basis.
- (b) The permittee shall calculate emissions of NO_x and CO from each ladle preheater on a monthly basis and as a 12-month rolling sum. Emissions of NO_x and CO shall be calculated using the most current stack test results performed on one of the ladle preheaters covered under Source IDs 229A and 229B.

006 [25 Pa. Code §127.441]**Operating permit terms and conditions.**

- (a) The permittee shall maintain on site at all times documentation of tune-ups performed on this source.
- (b) The permittee shall maintain on site at all times the manufacturer's recommended tune-up requirements.

[Compliance with this streamlined condition also assures compliance with 25 Pa. Code § 129.97(c)(3)]

V. REPORTING REQUIREMENTS.

No additional reporting requirements exist except as provided in other sections of this permit including Section B (Title V General Requirements).

VI. WORK PRACTICE REQUIREMENTS.**# 007 [25 Pa. Code §127.441]****Operating permit terms and conditions.**

- (a) This source shall be tuned up annually, such that tune-ups occur no more than 14 months apart and no sooner than 10 months apart.
- (b) Tune-ups shall occur according to manufacturer specifications.

[Compliance with this streamlined condition also assures compliance with 25 Pa. Code § 129.97(c)(3)]

VII. ADDITIONAL REQUIREMENTS.**# 008 [25 Pa. Code §127.441]****Operating permit terms and conditions.**

This source, Ladle Pre-Heaters "B" and "D" (Source ID 229B), consists of two (2) units, each rated 12.0 MMBtu/hr each.

***** Permit Shield in Effect. *****

**SECTION D. Source Level Requirements**

Source ID: 230

Source Name: VACUUM OXYGEN DECARBURIZATION (VOD)

Source Capacity/Throughput:

75.000 Tons/HR

LIQUID METAL

8.400 MCF/HR

Natural Gas

**I. RESTRICTIONS.****Emission Restriction(s).**

001 [25 Pa. Code §123.13]

Processes

See applicable particulate matter restrictions for this source under associated control device - Source ID: C090.

002 [25 Pa. Code §123.21]

GeneralThe permittee may not permit the emission into the outdoor atmosphere of sulfur oxides from a source in a manner that the concentration of the sulfur oxides, expressed as SO₂, in the effluent gas exceeds 500 parts per million, by volume, dry basis.**Throughput Restriction(s).**

003 [25 Pa. Code §127.441]

Operating permit terms and conditions.

[Additional authority for this permit condition is also derived from 25 Pa. Code § 127.512(h)]

(a) The permittee shall ensure that the Vacuum Oxygen Decarburization (VOD) process is limited to a maximum throughput of 545,250 tons of metal per year on a twelve (12) month rolling basis.

(b) The permittee shall ensure that the amount of natural gas used in the flare and associated pilot shall not exceed 61.4 million cubic feet per year on a twelve (12) month rolling basis.

II. TESTING REQUIREMENTS.

No additional testing requirements exist except as provided in other sections of this permit including Section B (Title V General Requirements).

III. MONITORING REQUIREMENTS.

004 [25 Pa. Code §127.441]

Operating permit terms and conditions.

The permittee shall monitor the parameters on a monthly basis:

(a) Metal throughput for the VOD process (Source ID: 230);

(b) Fuel usage or hours of operation for the VOD Flare (Source ID: C104).

**SECTION D. Source Level Requirements****IV. RECORDKEEPING REQUIREMENTS.****# 005 [25 Pa. Code §127.441]****Operating permit terms and conditions.**

The permittee shall maintain records of the following on a monthly basis for the VOD Process (Source ID: 230):

- (a) Metal throughput for the VOD Process (Source ID: 230);
- (b) Fuel usage or hours of operation for the VOD Flare (Source ID: C104).

V. REPORTING REQUIREMENTS.

No additional reporting requirements exist except as provided in other sections of this permit including Section B (Title V General Requirements).

VI. WORK PRACTICE REQUIREMENTS.**# 006 [25 Pa. Code §127.441]****Operating permit terms and conditions.**

The permittee shall ensure that the VOD Flare (Source ID: C104) is operating whenever the VOD process (Source ID: 230) is operational.

007 [25 Pa. Code §127.441]**Operating permit terms and conditions.**

[Additional authority for this permit condition is derived from 25 Pa. Code § 129.97(c)]

- (a) The permittee shall maintain and operate this source in accordance with the manufacturer's specifications and with good operating practices.
- (b) In instances where the manufacturer's specification information is no longer available or applicable, the permittee shall ensure that the source shall be maintained and operated in a manner consistent with safety and good air pollution control practices for minimizing emissions.

VII. ADDITIONAL REQUIREMENTS.**# 008 [25 Pa. Code §127.441]****Operating permit terms and conditions.**

This source group (Source ID: 230) consists of the Vacuum Oxygen Decarburization (VOD) process and a natural gas flare (Source ID: C104).

***** Permit Shield in Effect. *****

**SECTION D. Source Level Requirements**

Source ID: 231

Source Name: EMS LADLE DRYER/PREHEATER

Source Capacity/Throughput:

10.000 MCF/HR

Natural Gas

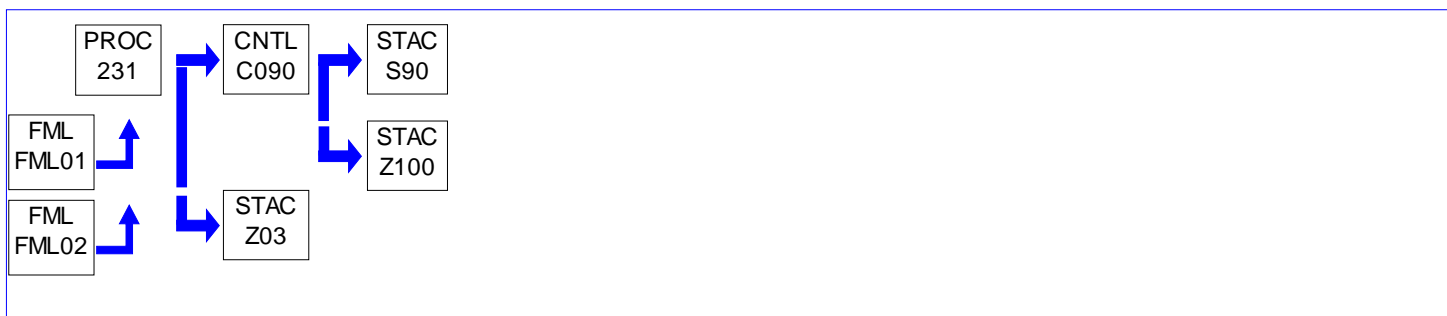
**I. RESTRICTIONS.****Emission Restriction(s).**

001 [25 Pa. Code §123.13]

Processes

See applicable particulate matter restrictions for this source under associated control device - Source ID: C090.

002 [25 Pa. Code §123.21]

GeneralThe permittee may not permit the emission into the outdoor atmosphere of sulfur oxides from a source in a manner that the concentration of the sulfur oxides, expressed as SO₂, in the effluent gas exceeds 500 parts per million, by volume, dry basis.**II. TESTING REQUIREMENTS.**

No additional testing requirements exist except as provided in other sections of this permit including Section B (Title V General Requirements).

III. MONITORING REQUIREMENTS.

003 [25 Pa. Code §127.441]

Operating permit terms and conditions.

The permittee shall monitor the amount of fuel used or the hours of operation for this source on a monthly basis.

IV. RECORDKEEPING REQUIREMENTS.

004 [25 Pa. Code §127.441]

Operating permit terms and conditions.

The permittee shall maintain records of the fuel used or the hours of operation for this source on a monthly basis.

V. REPORTING REQUIREMENTS.

No additional reporting requirements exist except as provided in other sections of this permit including Section B (Title V General Requirements).

VI. WORK PRACTICE REQUIREMENTS.

005 [25 Pa. Code §127.441]

Operating permit terms and conditions.

[Additional authority for this permit condition is derived from 25 Pa. Code § 129.97(c)]

(a) The permittee shall maintain and operate this source in accordance with the manufacturer's specifications and with good operating practices.

**SECTION D. Source Level Requirements**

(b) In instances where the manufacturer's specification information is no longer available or applicable, the permittee shall ensure that the source shall be maintained and operated in a manner consistent with safety and good air pollution control practices for minimizing emissions.

VII. ADDITIONAL REQUIREMENTS.

No additional requirements exist except as provided in other sections of this permit including Section B (Title V General Requirements).

***** Permit Shield in Effect. *****

**SECTION D. Source Level Requirements**

Source ID: 232

Source Name: SLAG SKIMMING-VOD & BAGHOUSE

Source Capacity/Throughput: 75.000 Tons/HR SLAG

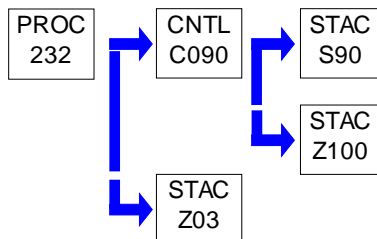
**I. RESTRICTIONS.****Emission Restriction(s).**

001 [25 Pa. Code §123.13]

Processes

See applicable particulate matter restrictions for this source under associated control device - Source ID: C090.

002 [25 Pa. Code §123.21]

GeneralNo person may permit the emission into the outdoor atmosphere of sulfur oxides from this source in a manner that the concentration of the sulfur oxides, expressed as SO₂, in the effluent gas exceeds 500 ppmvd.**II. TESTING REQUIREMENTS.**

No additional testing requirements exist except as provided in other sections of this permit including Section B (Title V General Requirements).

III. MONITORING REQUIREMENTS.

No additional monitoring requirements exist except as provided in other sections of this permit including Section B (Title V General Requirements).

IV. RECORDKEEPING REQUIREMENTS.

003 [25 Pa. Code §127.441]

Operating permit terms and conditions.

The permittee shall maintain records necessary to calculate emissions of air pollutants from the Slag Skimming-VOD process (Source ID: 232).

V. REPORTING REQUIREMENTS.

No additional reporting requirements exist except as provided in other sections of this permit including Section B (Title V General Requirements).

VI. WORK PRACTICE REQUIREMENTS.

No additional work practice requirements exist except as provided in other sections of this permit including Section B (Title V General Requirements).

VII. ADDITIONAL REQUIREMENTS.

004 [25 Pa. Code §127.441]

Operating permit terms and conditions.

**SECTION D. Source Level Requirements**

The permittee shall ensure that the particulate matter emissions from the Slag Skimming-VOD process (Source ID: 232) is exhausted to Baghouse "E" (Source ID: C090).

***** Permit Shield in Effect. *****

**SECTION D. Source Level Requirements**

Source ID: 234

Source Name: TEEMING PROCESS & BAGHOUSE

Source Capacity/Throughput: 165.000 Tons/HR LIQUID STEEL

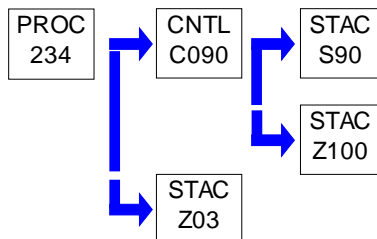
**I. RESTRICTIONS.****Emission Restriction(s).**

001 [25 Pa. Code §123.13]

Processes

See applicable particulate matter restrictions for this source under associated control device - Source ID: C090.

002 [25 Pa. Code §123.21]

GeneralNo person may permit the emission into the outdoor atmosphere of sulfur oxides from this source in a manner that the concentration of the sulfur oxides, expressed as SO₂, in the effluent gas exceeds 500 ppmvd.**II. TESTING REQUIREMENTS.**

No additional testing requirements exist except as provided in other sections of this permit including Section B (Title V General Requirements).

III. MONITORING REQUIREMENTS.

No additional monitoring requirements exist except as provided in other sections of this permit including Section B (Title V General Requirements).

IV. RECORDKEEPING REQUIREMENTS.

003 [25 Pa. Code §127.441]

Operating permit terms and conditions.

The permittee shall maintain necessary records to calculate emissions of air pollutants from the Teeming Process (Source ID: 234).

V. REPORTING REQUIREMENTS.

No additional reporting requirements exist except as provided in other sections of this permit including Section B (Title V General Requirements).

VI. WORK PRACTICE REQUIREMENTS.

No additional work practice requirements exist except as provided in other sections of this permit including Section B (Title V General Requirements).

VII. ADDITIONAL REQUIREMENTS.

004 [25 Pa. Code §127.441]

Operating permit terms and conditions.

**SECTION D. Source Level Requirements**

The permittee shall ensure that the particulate matter emissions from the Teeming Process (Source ID: 234) exhausts to Baghouse "E" (Source ID: C090).

***** Permit Shield in Effect. *****

**SECTION D. Source Level Requirements**

Source ID: 235

Source Name: SLAB CUT-OFF TORCH & BAGHOUSE

Source Capacity/Throughput:

2.100 MCF/HR

Natural Gas

**I. RESTRICTIONS.****Emission Restriction(s).**

001 [25 Pa. Code §123.13]

Processes

See applicable particulate matter restrictions for this source under associated control device - C105.

002 [25 Pa. Code §123.21]

GeneralThe permittee may not permit the emission into the outdoor atmosphere of sulfur oxides from a source in a manner that the concentration of the sulfur oxides, expressed as SO₂, in the effluent gas exceeds 500 parts per million, by volume, dry basis.

003 [25 Pa. Code §127.441]

Operating permit terms and conditions.

[Additional authority for this permit condition is also derived from 25 Pa. Code § 127.512(h)]

The permittee shall ensure that the concentrations of Chromium and Nickel emissions exhausting from the Slab Cut-Off Torch Baghouse Stack (Source ID: S122) shall not exceed the following emission rates:

Pollutant	Emission Rate
(a) Chromium	0.375 lb/hr
(b) Nickel	0.216 lb/hr

II. TESTING REQUIREMENTS.

No additional testing requirements exist except as provided in other sections of this permit including Section B (Title V General Requirements).

III. MONITORING REQUIREMENTS.

004 [25 Pa. Code §127.441]

Operating permit terms and conditions.

The permittee shall monitor the fuel usage or the hours of operation for the Slab Cut-Off Torch (Source ID: 235) on a monthly basis.

IV. RECORDKEEPING REQUIREMENTS.

005 [25 Pa. Code §127.441]

Operating permit terms and conditions.

(a) The permittee shall maintain records of the fuel usage or the hours of operation for the Slab Cut-Off Torch (Source ID: 235) on a monthly basis.

(b) The permittee shall maintain necessary records for the Slab Cut-Off Torch (Source ID: 235) to calculate pollutant

**SECTION D. Source Level Requirements**

emissions and demonstrate compliance with the emission limits of this section.

V. REPORTING REQUIREMENTS.

No additional reporting requirements exist except as provided in other sections of this permit including Section B (Title V General Requirements).

VI. WORK PRACTICE REQUIREMENTS.

No additional work practice requirements exist except as provided in other sections of this permit including Section B (Title V General Requirements).

VII. ADDITIONAL REQUIREMENTS.**# 006 [25 Pa. Code §127.441]
Operating permit terms and conditions.**

The Slab Cut-Off Torch (Source ID: 235) consists of a natural gas fired iron powder burning torch cutting process equipped with a baghouse (Source ID: C105) manufactured by Amerex, Inc., Model No. RP-12-360-6P.

***** Permit Shield in Effect. *****

**SECTION D. Source Level Requirements**

Source ID: 237

Source Name: CASTER DECK

Source Capacity/Throughput: 271.000 Tons/HR LADLE

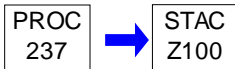
**I. RESTRICTIONS.****Emission Restriction(s).**

001 [25 Pa. Code §123.13]

Processes

The permittee may not permit the emission into the outdoor atmosphere of filterable particulate matter, as measured by Method 5 of 40 CFR 60, Appendix A (or an equivalent method approved by the Department), in a manner that the concentration of particulate matter in the effluent gas exceeds 0.04 grains per dry standard cubic foot.

II. TESTING REQUIREMENTS.

No additional testing requirements exist except as provided in other sections of this permit including Section B (Title V General Requirements).

III. MONITORING REQUIREMENTS.

No additional monitoring requirements exist except as provided in other sections of this permit including Section B (Title V General Requirements).

IV. RECORDKEEPING REQUIREMENTS.

002 [25 Pa. Code §127.441]

Operating permit terms and conditions.

The permittee shall maintain records necessary to calculate emissions of air pollutants from this source.

V. REPORTING REQUIREMENTS.

No additional reporting requirements exist except as provided in other sections of this permit including Section B (Title V General Requirements).

VI. WORK PRACTICE REQUIREMENTS.

No additional work practice requirements exist except as provided in other sections of this permit including Section B (Title V General Requirements).

VII. ADDITIONAL REQUIREMENTS.

No additional requirements exist except as provided in other sections of this permit including Section B (Title V General Requirements).

***** Permit Shield in Effect. *****

**SECTION D. Source Level Requirements**

Source ID: 238

Source Name: MOLD GRINDING & BAGHOUSE

Source Capacity/Throughput:

3.100 Lbs/HR

PARTICULATES

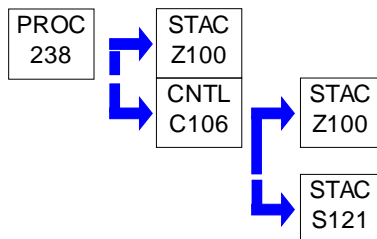
**I. RESTRICTIONS.****Emission Restriction(s).**

001 [25 Pa. Code §123.13]

Processes

See applicable particulate matter restrictions for this source under associated control device - Source ID: C106.

II. TESTING REQUIREMENTS.

No additional testing requirements exist except as provided in other sections of this permit including Section B (Title V General Requirements).

III. MONITORING REQUIREMENTS.

No additional monitoring requirements exist except as provided in other sections of this permit including Section B (Title V General Requirements).

IV. RECORDKEEPING REQUIREMENTS.

No additional record keeping requirements exist except as provided in other sections of this permit including Section B (Title V General Requirements).

V. REPORTING REQUIREMENTS.

No additional reporting requirements exist except as provided in other sections of this permit including Section B (Title V General Requirements).

VI. WORK PRACTICE REQUIREMENTS.

No additional work practice requirements exist except as provided in other sections of this permit including Section B (Title V General Requirements).

VII. ADDITIONAL REQUIREMENTS.

002 [25 Pa. Code §127.441]

Operating permit terms and conditions.

The permittee shall ensure that the particulate matter emissions from the Mold Grinding process (Source ID: 238) are exhausted to the Torit Downflow Baghouse (Source ID: C106, Model No. DF3DE2F).

***** Permit Shield in Effect. *****

**SECTION D. Source Level Requirements**

Source ID: 249

Source Name: SURFACE COATING

Source Capacity/Throughput:

50.000 Gal/HR

PAINT

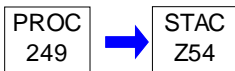
**I. RESTRICTIONS.**

No additional requirements exist except as provided in other sections of this permit including Section B (Title V General Requirements).

II. TESTING REQUIREMENTS.

No additional testing requirements exist except as provided in other sections of this permit including Section B (Title V General Requirements).

III. MONITORING REQUIREMENTS.**# 001 [25 Pa. Code §129.52]****Surface coating processes**

The permittee shall monitor the VOC content of the coatings and thinners used, as well as the volumes of each used on an on-going basis.

IV. RECORDKEEPING REQUIREMENTS.**# 002 [25 Pa. Code §129.52]****Surface coating processes**

(a) The permittee shall maintain records sufficient to demonstrate compliance with this section. At a minimum, a facility shall maintain daily records of:

(1) The following parameters for each coating, thinner and other component as supplied:

- (i) The coating, thinner or component name and identification number.
- (ii) The volume used.
- (iii) The mix ratio.
- (iv) The density of specific gravity.
- (v) The weight percent of total volatiles, water, solids and exempt solvents.
- (vi) The volume percent of solids for Table I of Section 129.52 of PA Code.

(2) The VOC content of each coating, thinner and other component as supplied.

(3) The VOC content of each as applied coating.

(b) The VOC content of the coatings shall either be provided by the manufacturer in certified product data sheets, material data safety sheets, or by appropriate EPA methods.

V. REPORTING REQUIREMENTS.

No additional reporting requirements exist except as provided in other sections of this permit including Section B (Title V General Requirements).

VI. WORK PRACTICE REQUIREMENTS.**# 003 [25 Pa. Code §127.441]****Operating permit terms and conditions.**

**SECTION D. Source Level Requirements**

[Additional authority for this permit condition is also derived from 40 CFR §§ 63.11169 and 63.11170]

(a) The permittee may not perform the following operations without prior approval from the delagated authority, unless otherwise stated in paragraph (b) of this condition:

- (1) Paint stripping operations that involve the use of chemical strippers that contain methylene chloride (MeCl), Chemical Abstract Service number 75092, in paint removal processes;
- (2) Spray application of coatings containing compounds of chromium (Cr), lead (Pb), manganese (Mn), nickel (Ni), or cadmium (Cd), collectively referred to as the target HAP to any part or product made of metal or plastic, or combinations of metal and plastic that are not motor vehicles or mobile equipment.

(b) In accordance with the definition of "spray-applied coating operations", as defined under 40 CFR § § 63.11180, the following are exempt from the restriction in paragraph (a)(2), above:

- (1) Coatings applied from a hand-held device with a paint cup capacity that is equal to or less than 3.0 fluid ounces (89 cubic centimeters).
- (2) Surface coating application using powder coating, hand-held, non-refillable aerosol containers, or non-atomizing application technology, including, but not limited to, paint brushes, rollers, hand wiping, flow coating, dip coating, electrodeposition coating, web coating, coil coating, touch-up markers, or marking pens.
- (3) Thermal spray operations (also known as metallizing, flame spray, plasma arc spray, and electric arc spray, among other names) in which solid metallic or non-metallic material is heated to a molten or semi-molten state and propelled to the work piece or substrate by compressed air or other gas, where a bond is produced upon impact.

(c) Compliance with paragraphs (a) and (b) assure that this source is not subject to 40 CFR Part 63, Subpart HHHHHH.

004 [25 Pa. Code §129.52]

Surface coating processes

(a) The permittee may not cause or permit the emission into the outdoor atmosphere of VOCs from plate coating processes, unless the VOC content of each as applied coating is equal to or less than 6.67 lbs. VOC per gallon coating solids.

(b) The VOC content of the as applied coating shall be calculated as stipulated in 25 Pa. Code § 129.52.

VII. ADDITIONAL REQUIREMENTS.

No additional requirements exist except as provided in other sections of this permit including Section B (Title V General Requirements).

***** Permit Shield in Effect. *****

**SECTION D. Source Level Requirements**

Source ID: 250

Source Name: IDENTIFICATION MARKING

Source Capacity/Throughput: 50.000 Gal/HR PAINT

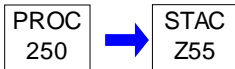
**I. RESTRICTIONS.****Emission Restriction(s).**

001 [25 Pa. Code §127.441]

Operating permit terms and conditions.

[Additional authority for this permit condition is also derived from 25 Pa. Code §§ 129.99]

Emissions of volatile organic compounds (VOC) from this source shall not exceed 9.40 tons per year.

II. TESTING REQUIREMENTS.

No additional testing requirements exist except as provided in other sections of this permit including Section B (Title V General Requirements).

III. MONITORING REQUIREMENTS.

002 [25 Pa. Code §127.441]

Operating permit terms and conditions.

[Additional authority for this permit condition is derived from 25 Pa. Code § 129.100]

The permittee shall monitor the VOC content of the spray cans used as well as the number of spray cans used on a monthly basis.

IV. RECORDKEEPING REQUIREMENTS.

003 [25 Pa. Code §127.441]

Operating permit terms and conditions.

[Additional authority for this permit condition is also derived from 25 Pa. Code § 129.100]

(a) The permittee shall maintain records sufficient to demonstrate compliance with the 12-month VOC emission limit. The following monthly records shall be maintained:

- (1) Number of spray cans.
- (2) VOC content of each spray can.
- (3) Total VOC emitted, in tons.

(b) The VOC content of the coatings shall be provided by the manufacturer on the spray cans or in a certified safety data sheet. Otherwise, the VOC content shall be determined by testing according to EPA methods.

V. REPORTING REQUIREMENTS.

No additional reporting requirements exist except as provided in other sections of this permit including Section B (Title V General Requirements).

VI. WORK PRACTICE REQUIREMENTS.

004 [25 Pa. Code §127.441]

Operating permit terms and conditions.

[Additional authority for this permit condition is also derived from 40 CFR §§ 63.11169 and 63.11170]

**SECTION D. Source Level Requirements**

(a) The permittee may not perform the following operations without prior approval from the EPA, unless otherwise stated in paragraph (b) of this condition:

- (1) Paint stripping operations that involve the use of chemical strippers that contain methylene chloride (MeCl), Chemical Abstract Service number 75092, in paint removal processes;
- (2) Spray application of coatings containing compounds of chromium (Cr), lead (Pb), manganese (Mn), nickel (Ni), or cadmium (Cd), collectively referred to as the target HAP to any part or product made of metal or plastic, or combinations of metal and plastic that are not motor vehicles or mobile equipment.

(b) In accordance with the definition of "spray-applied coating operations", as defined under 40 CFR § § 63.11180, the following are exempt from the restriction in paragraph (a)(2), above:

- (1) Coatings applied from a hand-held device with a paint cup capacity that is equal to or less than 3.0 fluid ounces (89 cubic centimeters).
- (2) Surface coating application using powder coating, hand-held, non-refillable aerosol containers, or non-atomizing application technology, including, but not limited to, paint brushes, rollers, hand wiping, flow coating, dip coating, electrodeposition coating, web coating, coil coating, touch-up markers, or marking pens.
- (3) Thermal spray operations (also known as metallizing, flame spray, plasma arc spray, and electric arc spray, among other names) in which solid metallic or non-metallic material is heated to a molten or semi-molten state and propelled to the work piece or substrate by compressed air or other gas, where a bond is produced upon impact.

(c) Compliance with paragraphs (a) and (b) assure that this source is not subject to 40 CFR Part 63, Subpart HHHHHH.

VII. ADDITIONAL REQUIREMENTS.

No additional requirements exist except as provided in other sections of this permit including Section B (Title V General Requirements).

***** Permit Shield in Effect. *****

**SECTION D. Source Level Requirements**

Source ID: 254

Source Name: NICKEL PLATING LINE AND 2 SCRUBBERS

Source Capacity/Throughput:

20.000 Tons/HR

STEEL PLATES

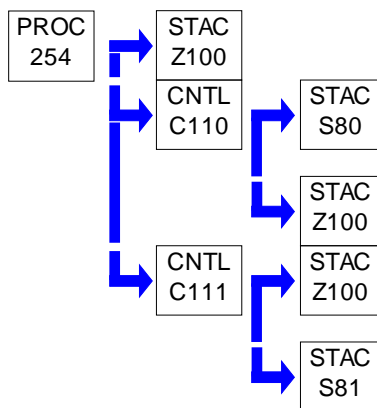
**I. RESTRICTIONS.****Emission Restriction(s).****# 001 [25 Pa. Code §123.13]****Processes**

The permittee shall not permit the emission into the outdoor atmosphere of filterable particulate matter, as measured by Method 5 of 40 CFR 60, Appendix A (or an equivalent method approved by the Department), from this source in a manner that the concentration of particulate matter in the effluent gas exceeds 0.04 grain per dry standard cubic foot.

II. TESTING REQUIREMENTS.

No additional testing requirements exist except as provided in other sections of this permit including Section B (Title V General Requirements).

III. MONITORING REQUIREMENTS.**# 002 [25 Pa. Code §127.441]****Operating permit terms and conditions.**

The permittee shall monitor the pressure drop across the Plate Cleaning Line Scrubber (Source ID C110) and the Nickel Plating Line Scrubber (Source ID C111) on a weekly basis.

IV. RECORDKEEPING REQUIREMENTS.**# 003 [25 Pa. Code §127.441]****Operating permit terms and conditions.**

The permittee shall maintain records of the weekly pressure drop readings across the Plate Cleaning Line Scrubber (Source ID C110) and the Nickel Plating Line Scrubber (Source ID C111).

004 [40 CFR Part 63 NESHAPS for Source Categories §40 CFR 63.11509]**Subpart WWWW - National Emission Standards for Hazardous Air Pollutants: Area Source Standards for Plating and Polishing Operations****What are my notification, reporting, and recordkeeping requirements?**

(a) The permittee must keep the records specified in paragraphs (a)(1) through (3) of this condition.

(1) A copy of any Initial Notification and Notification of Compliance Status that you submitted and all documentation supporting those notifications.

(2) The records specified below:

**SECTION D. Source Level Requirements**

(i) The occurrence and duration of each startup or shutdown when the startup or shutdown causes the source to exceed any applicable emission limitation in the relevant emission standards:

(ii) The occurrence and duration of each malfunction of operation (i.e., process equipment) or the required air pollution control and monitoring equipment;

(iii) All required maintenance performed on the air pollution control and monitoring equipment;

(3) The records required to show continuous compliance with each management practice and equipment standard that applies to the permittee, as specified in 40 CFR §§ 63.11508(d)(1), (2), (4), and (8).

(b) The permittee must keep each record for a minimum of 5 years following the date of each occurrence, measurement, maintenance, corrective action, report, or record. The permittee must keep each record onsite for at least 2 years after the date of each occurrence, measurement, maintenance, corrective action, report, or record, according to 40 CFR § 63.10(b)(1) of the General Provisions to Part 63. The permittee may keep the records offsite for the remaining 3 years.

V. REPORTING REQUIREMENTS.

005 [40 CFR Part 63 NESHAPS for Source Categories §40 CFR 63.11509]

Subpart WWWW - National Emission Standards for Hazardous Air Pollutants: Area Source Standards for Plating and Polishing Operations

What are my notification, reporting, and recordkeeping requirements?

(a) The permittee must prepare an annual certification of compliance report according to the requirements of this condition. These reports do not need to be submitted unless a deviation from the requirements of this operating permit has occurred during the reporting year, in which case, the annual compliance report must be submitted along with the deviation report.

(1) If the permittee owns or operates an affected electroplating, electroforming, or electropolishing tank that is subject to the requirements in 40 CFR § 63.11507(a), and the permittee uses a control system to comply with 40 CFR Part 63, Subpart WWWW (6W), the permittee must state in the annual certification that the permittee has operated and maintained the control system according to the manufacturer's specifications and instructions.

(2) If the permittee owns or operates an affected tank or other affected plating and polishing operation that is subject to the management practices specified in 40 CFR § 63.11507(g), the permittee must state in the annual compliance certification that the permittee has implemented the applicable management practices, as practicable.

(3) Each annual compliance report must be prepared no later than January 31 of the year immediately following the reporting period and kept in a readily-accessible location for inspector review. If a deviation has occurred during the year, each annual compliance report must be submitted along with the deviation report, and postmarked or delivered no later than January 31 of the year immediately following the reporting period.

(b) If the permittee owns or operates an affected source, and any deviations from the above compliance requirements occurred during the year, the permittee must report the deviations, along with the corrective action taken, no later than January 31 of the year immediately following the reporting period to EPA.

VI. WORK PRACTICE REQUIREMENTS.

006 [25 Pa. Code §127.441]

Operating permit terms and conditions.

The permittee shall ensure the following operating parameters for the Nickel Plating Process (Source ID: 254):

(a) Plate Cleaning Line Scrubber (Source ID C110) shall vent tanks numbered TA-1 through TA-5.

(b) Nickel Plating Line Scrubber (Source ID C111) shall vent tanks numbered TA-6 through TA-10.

(c) Only tanks No. TA-6, TA-7 and TA-8 shall contain nickel (Ni) compounds used for plating purposes.

**SECTION D. Source Level Requirements****# 007 [25 Pa. Code §127.441]****Operating permit terms and conditions.**

The permittee shall ensure that a minimum pressure differential across the Plate Cleaning Line Scrubber (Source ID C110) and the Nickel Plating Line Scrubber (Source ID C111) shall be maintained at 0.8 inches water gauge (w.g.).

008 [40 CFR Part 63 NESHAPS for Source Categories §40 CFR 63.11507]**Subpart WWWW - National Emission Standards for Hazardous Air Pollutants: Area Source Standards for Plating and Polishing Operations****What are my standards and management practices?**

(a) If the permittee owns or operates a non-cyanide electroplating, electroforming, or electropolishing tank (also identified as an "electrolytic" process tank) that contains one or more of the plating and polishing metal HAP and operates at a pH of less than 12, the permittee shall comply with the following requirement, and implement the applicable management practices in paragraph (e) of this condition, as practicable: The permittee must capture and exhaust emissions from the affected tank to any one of the following emission control devices: composite mesh pad, packed bed scrubber, or mesh pad mist eliminator, according to paragraphs (a)(1) and (2) of this condition:

(1) The permittee must operate all capture and control devices according to the manufacturer's specifications and operating instructions.

(2) The permittee must keep the manufacturer's specifications and operating instructions at the facility at all times in a location where they can be easily accessed by the operators.

(b) If the permittee owns or operates a plating and polishing process unit that contains, applies, or emits one or more of the plating and polishing metal HAP, the permittee must implement the applicable management practices listed below, as practicable.

(1) Maximize the draining of bath solution back into the tank, as practicable, by extending drip time when removing parts from the tank; using drain boards (also known as drip shields); or withdrawing parts slowly from the tank, as practicable.

(2) Minimize or reduce heating of process tanks, as practicable (e.g., when doing so would not interrupt production or adversely affect part quality).

(3) Perform regular repair, maintenance, and preventive maintenance of racks, barrels, and other equipment associated with affected sources, as practicable.

(4) Minimize bath contamination, such as through the prevention or quick recovery of dropped parts, use of distilled/de-ionized water, water filtration, pre-cleaning of parts to be plated, and thorough rinsing of pre-treated parts to be plated, as practicable.

(5) Maintain quality control of chemicals, and chemical and other bath ingredient concentrations in the tanks, as practicable.

(6) Perform general good housekeeping, such as regular sweeping or vacuuming, if needed, and periodic washdowns, as practicable.

(7) Minimize spills and overflow of tanks, as practicable.

(8) Perform regular inspections to identify leaks and other opportunities for pollution prevention.

VII. ADDITIONAL REQUIREMENTS.**# 009 [25 Pa. Code §127.441]****Operating permit terms and conditions.**

(a) Source ID 254 is subject to 40 CFR Part 63, Subpart WWWW (6W), except as specified in paragraph (b) below. Source ID 254 shall comply with all applicable requirements.

**SECTION D. Source Level Requirements**

(b) Any plating or polishing process that uses process materials that contain cadmium, chromium, lead, or nickel (as the metal) in amounts less than 0.1 percent by weight, or that contain manganese in amounts less than 1.0 percent by weight (as the metal), as used, is exempt from 40 CFR Part 63, Subpart WWWW (6W). Information used to determine the amount of plating and polishing metal HAP in materials used in the plating or polishing process may include information reported on the Material Safety Data Sheet for the material, but is not required. For plating or polishing tanks, the HAP content may be determined from the final bath contents "as used" to plate or to polish.

***** Permit Shield in Effect. *****

**SECTION D. Source Level Requirements**

Source ID: 258

Source Name: HORIZONTAL GRIT BLASTER AND BAGHOUSE

Source Capacity/Throughput: 18.000 Tons/HR STEEL PLATES

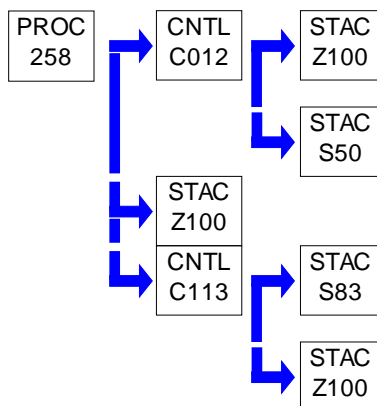
**I. RESTRICTIONS.****Emission Restriction(s).**

001 [25 Pa. Code §127.441]

Operating permit terms and conditions.

[Additional authority for this permit condition is also derived from 25 Pa. Code § 127.512(h)]

The permittee shall ensure that the total controlled particulate matter emissions from the Horizontal Grit Blast Machine shall be limited to 1.15 pounds per hour and 4.31 tons per year as a twelve (12) month rolling sum.

002 [25 Pa. Code §123.13]

Processes

See applicable particulate matter restrictions for this source under associated control device - Source ID(s): C012 and C113.

Operation Hours Restriction(s).

003 [25 Pa. Code §127.441]

Operating permit terms and conditions.

[Additional authority for this permit condition is also derived from 25 Pa. Code § 127.512(h)]

The permittee shall limit the hours of operation of the Horizontal Grit Blast Machine to 7,500 hours per twelve (12) month rolling period.

II. TESTING REQUIREMENTS.

No additional testing requirements exist except as provided in other sections of this permit including Section B (Title V General Requirements).

III. MONITORING REQUIREMENTS.

004 [25 Pa. Code §127.441]

Operating permit terms and conditions.

The permittee shall monitor the hours of operation of the Horizontal Grit Blast Machine process on a monthly basis.

IV. RECORDKEEPING REQUIREMENTS.

005 [25 Pa. Code §127.441]

**SECTION D. Source Level Requirements****Operating permit terms and conditions.**

The permittee shall record the hours of operation of the Horizontal Grit Blast Machine process on a monthly basis, and as a twelve (12) month rolling sum.

006 [25 Pa. Code §127.441]**Operating permit terms and conditions.**

The permittee shall calculate and record emissions of particulate matter from the Horizontal Grit Blaster Machine (Source ID: 258) on a monthly basis, and as a twelve (12) month rolling sum, to demonstrate compliance to the annual emission rates for this source.

V. REPORTING REQUIREMENTS.

No additional reporting requirements exist except as provided in other sections of this permit including Section B (Title V General Requirements).

VI. WORK PRACTICE REQUIREMENTS.**# 007 [25 Pa. Code §127.441]****Operating permit terms and conditions.**

The permittee shall ensure that particulate matter emissions from the Horizontal Grit Blast Machine shall be controlled by either the Pangborn Baghouse (Source ID: C012, Model # 195-HP-1015-TS) or the Farr Baghouse (Source ID: C113, Model # 32-D).

008 [25 Pa. Code §127.441]**Operating permit terms and conditions.**

The permittee shall ensure that dampers are in the supply ducts to Pangborn Baghouse (Source ID: C012) and the Farr Baghouse (Source ID: C113) which permit the operation of either the Vertical Grit Blast Machine (Source ID: 176) or the Horizontal Grit Blast Machine (Source ID: 258) with either control device. If both grit blast machines are operated simultaneously, the permittee shall ensure that both baghouses shall be utilized.

VII. ADDITIONAL REQUIREMENTS.

No additional requirements exist except as provided in other sections of this permit including Section B (Title V General Requirements).

***** Permit Shield in Effect. *****

**SECTION D. Source Level Requirements**

Source ID: 270

Source Name: CONTINUOUS CASTING SPRAY CHAMBER

Source Capacity/Throughput: 93.600 Tons/HR STRAND

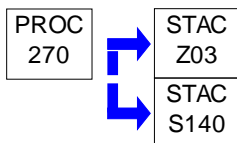
**I. RESTRICTIONS.****Emission Restriction(s).****# 001 [25 Pa. Code §123.13]****Processes**

No person may permit the emission into the outdoor atmosphere of filterable particulate matter, as measured by Method 5 of 40 CFR 60, Appendix A (or an equivalent method approved by the Department), from this source at any time, in excess of 0.04 grains per dry standard cubic foot.

002 [25 Pa. Code §127.441]**Operating permit terms and conditions.**

[Additional authority for this permit condition is derived from 25 Pa. Code § 127.512(h) and 25 Pa. Code § 129.99]

Emissions of volatile organic compounds (VOC) from this source shall not exceed 9.02 tons per 12-month rolling period.

Throughput Restriction(s).**# 003 [25 Pa. Code §127.441]****Operating permit terms and conditions.**

[Additional authority for this permit condition is derived from 25 Pa. Code § 127.512(h) and 25 Pa. Code § 129.99]

The permittee shall ensure that the throughput of steel through this source does not exceed 820,000 tons of steel per year.

II. TESTING REQUIREMENTS.

No additional testing requirements exist except as provided in other sections of this permit including Section B (Title V General Requirements).

III. MONITORING REQUIREMENTS.**# 004 [25 Pa. Code §127.441]****Operating permit terms and conditions.**

[Additional authority for this permit condition is derived from 25 Pa. Code § 129.100]

The permittee shall monitor the amount of steel processed through the Continuous Casting Spray Chamber (Source ID: 270) on a monthly basis.

IV. RECORDKEEPING REQUIREMENTS.**# 005 [25 Pa. Code §127.441]****Operating permit terms and conditions.**

[Additional authority for this permit condition is derived from 25 Pa. Code § 129.100]

(a) The permittee shall record the amount of steel processed through the Continuous Casting Spray Chamber (Source ID: 270) on a monthly basis and as a 12-month rolling sum.

(b) The permittee shall calculate and record emissions of VOC, in tons, on a monthly basis and as a 12-month rolling sum.



SECTION D. Source Level Requirements

V. REPORTING REQUIREMENTS.

No additional reporting requirements exist except as provided in other sections of this permit including Section B (Title V General Requirements).

VI. WORK PRACTICE REQUIREMENTS.

No additional work practice requirements exist except as provided in other sections of this permit including Section B (Title V General Requirements).

VII. ADDITIONAL REQUIREMENTS.

No additional requirements exist except as provided in other sections of this permit including Section B (Title V General Requirements).

***** Permit Shield in Effect. *****

**SECTION D. Source Level Requirements**

Source ID: 768

Source Name: EMER PUMP/GENERATOR (20 MM GAL RESERVIOR)

Source Capacity/Throughput:

25.000 Gal/HR

Diesel Fuel

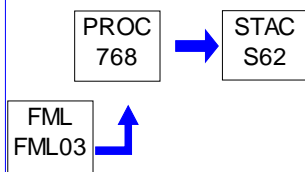
**I. RESTRICTIONS.****Emission Restriction(s).****# 001 [25 Pa. Code §123.21]****General**

The permittee may not permit the emission into the outdoor atmosphere of sulfur oxides from a source in a manner that the concentration of the sulfur oxides, expressed as SO₂, in the effluent gas exceeds 500 parts per million, by volume, dry basis.

Operation Hours Restriction(s).**# 002 [25 Pa. Code §127.441]****Operating permit terms and conditions.**

[Additional authority for this permit condition is also derived from 25 Pa. Code § 127.512(h) and 25 Pa. Code § 129.97(c)]

(a) The permittee shall not operate the emergency pump, nor the 250-kW emergency generator, for more than 500 hours in any consecutive twelve (12) month period.

(b) A RICE identified under Source ID 768 may NOT be used for the following purposes, which would otherwise be allowed under 40 CFR Part 63, Subpart ZZZZ, as specified in 40 CFR § 63.6640(f):

- (1) Emergency demand response.
- (2) Periods where there is a deviation of voltage or frequency.
- (3) Supplying power as part of a financial arrangement with another entity or to generate income.
- (4) Peak shaving.
- (5) Non-emergency demand response.

(c) Subject to the restrictions in paragraph (b) of this condition, the permittee shall operate the RICE identified under Source ID 768 only for the purposes allowed by 40 CFR § 63.6640(f) to render the fuel restrictions in 40 CFR § 63.6604(b) not applicable.

003 [40 CFR Part 63 NESHAPS for Source Categories §40 CFR 63.6625]**Subpart ZZZZ - National Emissions Standards for Hazardous Air Pollutants for Stationary Reciprocating Internal Combustion Engines****What are my monitoring, installation, operation, and maintenance requirements?**

For each RICE identified under Source ID 768, the permittee shall minimize the engine's time spent at idle during startup and minimize the engine's startup time to a period needed for appropriate and safe loading of the engine, not to exceed 30 minutes.

004 [40 CFR Part 63 NESHAPS for Source Categories §40 CFR 63.6640]**Subpart ZZZZ - National Emissions Standards for Hazardous Air Pollutants for Stationary Reciprocating Internal Combustion Engines****How do I demonstrate continuous compliance with the emission limitations, operating limitations, and other requirements?**

(a) The permittee shall operate this reciprocating internal combustion engines (RICE) according to the requirements in the most recent version of 40 CFR § 63.6640(f).

(b) If the permittee does not operate the engine according to the requirements of 40 CFR § 63.6640(f), the engine will not be

**SECTION D. Source Level Requirements**

considered an emergency engine under 40 CFR Part 63, Subpart ZZZZ, and must meet all requirements for non-emergency engines.

II. TESTING REQUIREMENTS.

No additional testing requirements exist except as provided in other sections of this permit including Section B (Title V General Requirements).

III. MONITORING REQUIREMENTS.**# 005 [25 Pa. Code §127.441]****Operating permit terms and conditions.**

[Additional authority for this permit condition is also derived from 40 CFR § 63.6625 and 25 Pa. Code § 129.97(c)]

Each RICE identified under Source ID 768 shall be equipped with a functional non-resettable hour meter to monitor the hours of operation of each RICE.

IV. RECORDKEEPING REQUIREMENTS.**# 006 [25 Pa. Code §127.441]****Operating permit terms and conditions.**

[Additional authority for this permit condition is also derived from 40 CFR § 63.10(b)(1), 40 CFR § 63.6660, and 25 Pa. Code § 129.97(c)]

(a) Records required for Source ID 768 shall be in a form suitable and readily available for expeditious review.

(b) The permittee shall maintain each record for 5 years following the date of each occurrence, measurement, maintenance, corrective action, report, or record.

(c) The permittee shall keep each record readily accessible in hard copy or electronic form for at least 5 years after the date of each occurrence, measurement, maintenance, corrective action, report, or record.

(d) The permittee shall record on a monthly basis the number of hours that the emergency pump and the 250-kW emergency generator operate in order to calculate the emissions of air pollutants and to demonstrate compliance with the rolling 12-month operating hours restriction.

(e) The permittee shall maintain up-to-date records of the sulfur content of the fuel used in the emergency pump and the 250-kW emergency generator to help demonstrate compliance with the sulfur oxide limitation applicable to Source ID 768.

007 [40 CFR Part 63 NESHAPS for Source Categories §40 CFR 63.6655]**Subpart ZZZZ - National Emissions Standards for Hazardous Air Pollutants for Stationary Reciprocating Internal Combustion Engines****What records must I keep?**

[Additional authority for this permit condition is also derived from 40 CFR § 63.6640]

(a) The permittee shall maintain the following records for each RICE:

(1) Records of the occurrence and duration of each malfunction of operation (i.e., process equipment) and/or monitoring equipment.

(2) Records of all required maintenance performed on each unit and on the monitoring equipment, including oil analysis and results.

(3) Records of actions taken during periods of malfunction to minimize emissions in accordance with 40 CFR § 63.6605(b), including corrective actions to restore malfunctioning process and monitoring equipment to its normal

**SECTION D. Source Level Requirements**

or usual manner of operation.

(b) The permittee shall maintain records to demonstrate compliance with either of the following, for each RICE:

(1) Operating and maintaining the stationary RICE according to the manufacturer's emission-related operation and maintenance instructions;

(2) Operating and maintaining the stationary RICE according to a maintenance plan developed by the permittee such that it provides to the extent practicable for the maintenance and operation of the engine in a manner consistent with good air pollution control practice for minimizing emissions.

(c) The permittee must keep records of the hours of operation of each RICE identified under Source ID 768 that is recorded through a non-resettable hour meter, on an annual basis. The permittee must document how many hours are spent for emergency operation, including what classified the operation as an emergency, and how many hours are spent for non-emergency operation.

(d) If the permittee participates in an oil analysis program pursuant to 40 CFR § 63.6625(i), the permittee must keep records of the parameters that are analyzed as part of the program, the results of the analysis, and the oil changes for the engine. Otherwise, the permittee shall maintain the necessary documentation to demonstrate compliance with the oil change requirements identified under Work Practice Requirements, pursuant to 40 CFR § 63.6640.

V. REPORTING REQUIREMENTS.

008 [40 CFR Part 63 NESHAPS for Source Categories §40 CFR 63.6640]

Subpart ZZZZ - National Emissions Standards for Hazardous Air Pollutants for Stationary Reciprocating Internal Combustion Engines

How do I demonstrate continuous compliance with the emission limitations, operating limitations, and other requirements?

All deviations from applicable emission limitations or operating limitations in 40 CFR Part 63, Subpart ZZZZ, as set forth in this operating permit, shall be reported in the permittee's semiannual monitoring report required by Sections B and C of this operating permit.

VI. WORK PRACTICE REQUIREMENTS.

009 [25 Pa. Code §129.203]

Stationary internal combustion engines.

(a) By May 1, 2005, the owner or operator of a stationary internal combustion engine rated at greater than 1,000 horsepower and located in Bucks, Chester, Delaware, Montgomery or Philadelphia County shall comply with this section and 25 Pa. Code § 129.204 (relating to emission accountability). This section does not apply to naval marine combustion units operated by the United States Navy for the purposes of testing and operational training or to stationary internal combustion engines regulated under Chapter 145, Subchapter B (relating to emissions of NO_x from stationary internal combustion engines).

(b) By October 31, 2005, and each year thereafter, the owner or operator of the stationary internal combustion engine shall calculate the difference between the actual emissions from the unit during the period from May 1 through September 30 and the allowable emissions for that period.

(c) The owner or operator shall calculate allowable emissions by multiplying the cumulative hours of operations for the unit for the period by the horsepower rating of the unit and by the applicable emission rate set forth in paragraph (1) or (2).

(1) For a spark-ignited engine, 3.0 grams of NO_x per brake horsepower-hour.

(2) For a compression ignition stationary internal combustion engine firing diesel fuel or a combination of diesel fuel and natural gas, 2.3 grams of NO_x per brake horsepower-hour.

(d) Emissions from a stationary internal combustion engine that has been or is replaced by an electric motor may be

**SECTION D. Source Level Requirements**

counted as allowable emissions for purposes of this section and 25 Pa. Code § 129.204, as follows:

- (1) For a replaced spark-ignited engine, 3.0 grams of NO_x per brake horsepower-hour of the replacement motor, less 1.5 pounds of NO_x per MWH of electricity consumed by the replacement motor.
- (2) For a replaced compression ignition stationary internal combustion engine that fired diesel fuel or a combination of diesel fuel and natural gas, 2.3 grams of NO_x per brake horsepower-hour, less 1.5 pounds of NO_x per MWH of electricity consumed by the replacement motor.

010 [25 Pa. Code §129.204]**Emission accountability.**

(a) This section applies to units described in 25 Pa. Code §§ 129.201-129.203 (relating to boilers; stationary combustion turbines; and stationary internal combustion engines).

(b) The owner or operator shall determine actual emissions in accordance with one of the following:

(1) If the owner or operator of the unit is required to monitor NO_x emissions with a CEMS operated and maintained in accordance with a permit or State or Federal regulation, the CEMS data reported to the Department to comply with the monitoring and reporting requirements of this article shall be used. Any data invalidated under Chapter 139 (relating to sampling and testing) shall be substituted with data calculated using the potential emission rate for the unit or, if approved by the Department in writing, an alternative amount of emissions that is more representative of actual emissions that occurred during the period of invalid data.

(2) If the owner or operator of the unit is not required to monitor NO_x emissions with a CEMS, one of the following shall be used to determine actual emissions of NO_x:

(i) The 1-year average emission rate calculated from the most recent permit emission limit compliance demonstration test data for NO_x.

(ii) The maximum hourly allowable NO_x emission rate contained in the permit or the higher of the following:

(A) The highest rate determined by use of the emission factor for the unit class contained in the most up-to date version of the EPA publication, "AP-42 Compilation of Air Pollution Emission Factors."

(B) The highest rate determined by use of the emission factor for the unit class contained in the most up-to date version of EPA's "Factor Information Retrieval (FIRE)" data system.

(iii) CEMS data, if the owner or operator elects to monitor NO_x emissions with a CEMS. The owner or operator shall monitor emissions and report the data from the CEMS in accordance with Chapter 139 or Chapter 145 (relating to interstate pollution transport reduction). Any data invalidated under Chapter 139 shall be substituted with data calculated using the potential emission rate for the unit or, if approved by the Department in writing, an alternative amount of emissions that is more representative of actual emissions that occurred during the period of invalid data.

(iv) An alternate calculation and recordkeeping procedure based upon emissions testing and correlations with operating parameters. The operator of the unit shall demonstrate that the alternate procedure does not underestimate actual emissions throughout the allowable range of operating conditions. The alternate calculation and recordkeeping procedures must be approved by the Department, in writing, prior to implementation.

(c) The owner or operator of a unit subject to this section shall surrender to the Department one NO_x allowance, as defined in § 145.2 (relating to definitions), for each ton of NO_x by which the combined actual emissions exceed the allowable emissions of the units subject to this section at a facility from May 1 through September 30. The surrendered NO_x allowances shall be of current year vintage. For the purpose of determining the amount of allowances to surrender, any remaining fraction of a ton equal to or greater than 0.50 ton is deemed to equal 1 ton and any fraction of a ton less than 0.50 ton is deemed to equal zero tons.

(d) If the combined allowable emissions from units subject to this section at a facility from May 1 through September 30

**SECTION D. Source Level Requirements**

exceed the combined actual emissions from units subject to this section at the facility during the same period, the owner or operator may deduct the difference or any portion of the difference from the amount of actual emissions from units subject to this section at the owner or operator's other facilities.

(e) By November 1, 2005, and by November 1 of each year thereafter, an owner or operator of a unit subject to this section shall surrender the required NOx allowances to the Department's designated NOx allowance tracking system account and provide to the Department, in writing, the following:

- (1) The serial number of each NOx allowance surrendered.
- (2) The calculations used to determine the quantity of NOx allowances required to be surrendered.

(f) If an owner or operator fails to comply with subsection (e), the owner or operator shall by December 31 surrender three NOx allowances of the current or later year vintage for each NOx allowance that was required to be surrendered by November 1 of that year.

(g) The surrender of NOx allowances under subsection (f) does not affect the liability of the owner or operator of the unit for any fine, penalty or assessment, or an obligation to comply with any other remedy for the same violation, under the CAA or the act.

- (1) For purposes of determining the number of days of violation, if a facility has excess emissions for the period May 1 through September 30, each day in that period (153 days) constitutes a day in violation unless the owner or operator of the unit demonstrates that a lesser number of days should be considered.

- (2) Each ton of excess emissions is a separate violation.

**# 011 [40 CFR Part 63 NESHAPS for Source Categories §40 CFR 63.6625]
Subpart ZZZZ - National Emissions Standards for Hazardous Air Pollutants for Stationary Reciprocating Internal Combustion Engines
What are my monitoring, installation, operation, and maintenance requirements?**

[Additional authority for this permit condition is also derived from 40 CFR § 63.6605]

(a) The permittee shall operate and maintain each RICE identified under Source ID 768 according to the manufacturer's emission-related written instructions or develop a source specific maintenance plan which must provide to the extent practicable for the maintenance and operation of the engine in a manner consistent with good air pollution control practice for minimizing emissions.

(b) If the permittee participates in an oil analysis program pursuant to 40 CFR 63.6625(i), the analysis program must be part of the maintenance plan for each engine.

[Compliance with this streamlined condition also ensures compliance with 25 Pa. Code § 129.97(c)]

**# 012 [40 CFR Part 63 NESHAPS for Source Categories §40 CFR 63.6640]
Subpart ZZZZ - National Emissions Standards for Hazardous Air Pollutants for Stationary Reciprocating Internal Combustion Engines
How do I demonstrate continuous compliance with the emission limitations, operating limitations, and other requirements?**

[Additional authority for this permit condition is also derived from 40 CFR § 63.6625]

(a) The following requirements apply to all CI RICE identified under Source ID 768:

- (1) The permittee shall change the oil and filter in each unit every 500 hours of operation or annually, whichever comes first;
- (2) The permittee shall inspect the air cleaner in each unit every 1,000 hours of operation or annually, whichever comes first, and replace as necessary; and,

**SECTION D. Source Level Requirements**

(3) The permittee shall inspect all hoses and belts in each unit every 500 hours of operation or annually, whichever comes first, and replace as necessary.

(b) The permittee has the option of utilizing an oil analysis program in order to extend the specified oil change requirements in paragraph (a) above. The oil analysis must be performed at the same frequency specified for changing the oil. The analysis program must at a minimum analyze the following, such that the oil meets the following parameters:

- (1) Total Base Number, such that it is greater than or equal to 30% of the Total Base Number of the oil when new;
- (2) Viscosity, such that it has not changed more than 20% from the viscosity of the oil when new; and,
- (3) Percent water content (by volume), such that it is not greater than 0.5.

(c) If the permittee complies with all applicable parameters in paragraph (b) above, the permittee is not required to change the oil. If any of the parameters are exceeded, the permittee must change the oil within 2 business days of receiving the results of the analysis; if the engine is not in operation when the results of the analysis are received, the permittee must change the oil within 2 business days or before commencing operation, whichever is later.

VII. ADDITIONAL REQUIREMENTS.

013 [25 Pa. Code §127.441]

Operating permit terms and conditions.

Source ID: 768 consists of the following:

- (a) 2.95-MMBTU/hr emergency pump with a 20 MM-gallon reservoir.
- (b) 250-kW emergency generator (ARC Bldg).

***** Permit Shield in Effect. *****

**SECTION D. Source Level Requirements**

Source ID: 769

Source Name: NG EMERG ICU'S

Source Capacity/Throughput:

N/A

Natural Gas

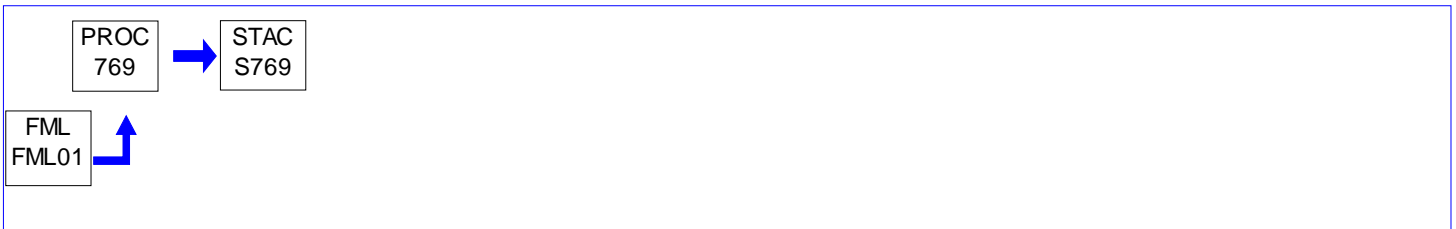
**I. RESTRICTIONS.****Emission Restriction(s).****# 001 [25 Pa. Code §123.13]****Processes**

The permittee may not permit the emission into the outdoor atmosphere of filterable particulate matter, as measured by Method 5 of 40 CFR 60, Appendix A (or an equivalent method approved by the Department), in a manner that the concentration of particulate matter in the effluent gas exceeds 0.04 grains per dry standard cubic foot.

002 [25 Pa. Code §123.21]**General**

The permittee may not permit the emission into the outdoor atmosphere of sulfur oxides from a source in a manner that the concentration of the sulfur oxides, expressed as SO₂, in the effluent gas exceeds 500 parts per million, by volume, dry basis.

003 [40 CFR Part 60 Standards of Performance for New Stationary Sources §40 CFR 60.4231]**Subpart JJJJ - Standards of Performance for Stationary Spark Ignition Internal Combustion Engines stationary SI internal combustion engines or equipment containing such engines?**

The Eaton/EGEN17 engine shall be certified in accordance with 40 CFR Part 90.

Operation Hours Restriction(s).**# 004 [25 Pa. Code §127.441]****Operating permit terms and conditions.**

[Additional authority for this permit condition is also derived from 25 Pa. Code § 127.512(h) and 25 Pa. Code § 129.97(c)]

The permittee shall not operate the Eaton/EGEN17 for more than 500 hours each in any consecutive twelve (12) month period.

005 [40 CFR Part 60 Standards of Performance for New Stationary Sources §40 CFR 60.4243]**Subpart JJJJ - Standards of Performance for Stationary Spark Ignition Internal Combustion Engines****What are my compliance requirements if I am an owner or operator of a stationary SI internal combustion engine?**

(a) The permittee shall operate engines identified herein Source ID 769 according to the requirements in the most recent version of 40 CFR § 60.4243(d).

(b) If the permittee does not operate an engine according to the requirements of 40 CFR § 60.4243(d), the engine will not be considered an emergency engine under 40 CFR Part 60, Subpart JJJJ, and must meet all requirements for non-emergency engines.

(c) The permittee may operate engines under Source ID 769 using propane for a maximum of 100 hours each per year as an alternative fuel solely during emergency operations, but must keep records of such use. If propane is used for more than 100 hours per year in an engine that is not certified to the emission standards when using propane, the permittee is required to conduct a performance test to demonstrate compliance with the emission standards of 40 CFR § 60.4233. If performance testing is performed, testing shall be performed in accordance with the requirements of 40 CFR § 60.4244.

**SECTION D. Source Level Requirements****II. TESTING REQUIREMENTS.**

No additional testing requirements exist except as provided in other sections of this permit including Section B (Title V General Requirements).

III. MONITORING REQUIREMENTS.

**# 006 [40 CFR Part 60 Standards of Performance for New Stationary Sources §40 CFR 60.4237]
Subpart JJJJ - Standards of Performance for Stationary Spark Ignition Internal Combustion Engines
What are the monitoring requirements if I am an owner or operator of an emergency stationary SI internal combustion engine?**

[Additional authority for this permit condition is also derived from 25 Pa. Code § 129.97(c)]

The IC engines covered under Source ID 769 shall be equipped with a functional, non-resettable hour meter.

IV. RECORDKEEPING REQUIREMENTS.

**# 007 [40 CFR Part 60 Standards of Performance for New Stationary Sources §40 CFR 60.4243]
Subpart JJJJ - Standards of Performance for Stationary Spark Ignition Internal Combustion Engines
What are my compliance requirements if I am an owner or operator of a stationary SI internal combustion engine?**

If the permittee does not operate and maintain the certified stationary SI internal combustion engines and control devices (if applicable) according to the manufacturer's emission-related written instructions, the permittee must keep a maintenance plan and records of conducted maintenance to demonstrate compliance.

**# 008 [40 CFR Part 60 Standards of Performance for New Stationary Sources §40 CFR 60.4245]
Subpart JJJJ - Standards of Performance for Stationary Spark Ignition Internal Combustion Engines
What are my notification, reporting, and recordkeeping requirements if I am an owner or operator of a stationary SI internal combustion engine?**

The permittee shall keep records of the following:

- (a) Maintenance conducted on the engines.
- (b) If the stationary SI internal combustion engines are certified engines, documentation from the manufacturer that the engines are certified to meet the emission standards and information as required in 40 CFR Part 90 and 40 CFR Part 1048, as applicable.
- (c) If the stationary SI internal combustion engine is not a certified engine or is a certified engine operating in a non-certified manner and subject to 40 CFR § 60.4243(a)(2), documentation that the engine meets the emission standards of 40 CFR Part 90.

**# 009 [40 CFR Part 60 Standards of Performance for New Stationary Sources §40 CFR 60.4245]
Subpart JJJJ - Standards of Performance for Stationary Spark Ignition Internal Combustion Engines
What are my notification, reporting, and recordkeeping requirements if I am an owner or operator of a stationary SI internal combustion engine?**

[Additional authority for this permit condition is also derived from 25 Pa. Code § 129.97(c)]

- (a) The permittee shall keep records of the hours of operation for each emergency engine, including:
 - (1) How many hours are spent for emergency operation, including what classified the operation as an emergency; and,
 - (2) How many hours are spent for non-emergency operation.
- (b) The permittee shall maintain records of proper maintenance and if either emergency engine is operated in a non-certified manner the permittee must have a maintenance plan.
- (c) Records required for Source ID 769 shall be maintained for a minimum of five (5) years.

**SECTION D. Source Level Requirements****V. REPORTING REQUIREMENTS.**

No additional reporting requirements exist except as provided in other sections of this permit including Section B (Title V General Requirements).

VI. WORK PRACTICE REQUIREMENTS.

**# 010 [40 CFR Part 60 Standards of Performance for New Stationary Sources §40 CFR 60.4243]
Subpart JJJJ - Standards of Performance for Stationary Spark Ignition Internal Combustion Engines
What are my compliance requirements if I am an owner or operator of a stationary SI internal combustion engine?**

(a) The permittee shall operate and maintain each certified stationary SI internal combustion engine according to the manufacturer's emission-related written instructions; if the permittee adjusts engine settings according to and consistent with the manufacturer's instructions, the stationary SI internal combustion engine will not be considered out of compliance.

(b) If the permittee does not operate and maintain a certified stationary SI internal combustion engine according to the manufacturer's emission-related written instructions, the engine shall be considered a non-certified engine, and the permittee must demonstrate compliance according to 40 CFR § 60.4243(a)(2)(i), which requires that the permittee keep a maintenance plan and records of conducted maintenance to demonstrate compliance and must, to the extent practicable, maintain and operate the engine in a manner consistent with good air pollution control practice for minimizing emissions, but no performance testing is required.

[Compliance with this streamlined condition also ensures compliance with 25 Pa. Code § 129.97(c)]

VII. ADDITIONAL REQUIREMENTS.

**# 011 [25 Pa. Code §127.441]
Operating permit terms and conditions.**

Source ID 769 consists of the following source(s):

Engine ID/Location	Make/Model	HP	KW	Construction Date
140 Computer Rm Backup (Mill Comp Rm)	EATON/EGEN17	23	16	2009

***** Permit Shield in Effect. *****

**SECTION D. Source Level Requirements**

Source ID: 770

Source Name: SMALL EMERGENCY GENERATORS/PUMPS

Source Capacity/Throughput:

N/A

NATURAL GAS/PROPANE

N/A

DIESEL FUEL/GASOLINE

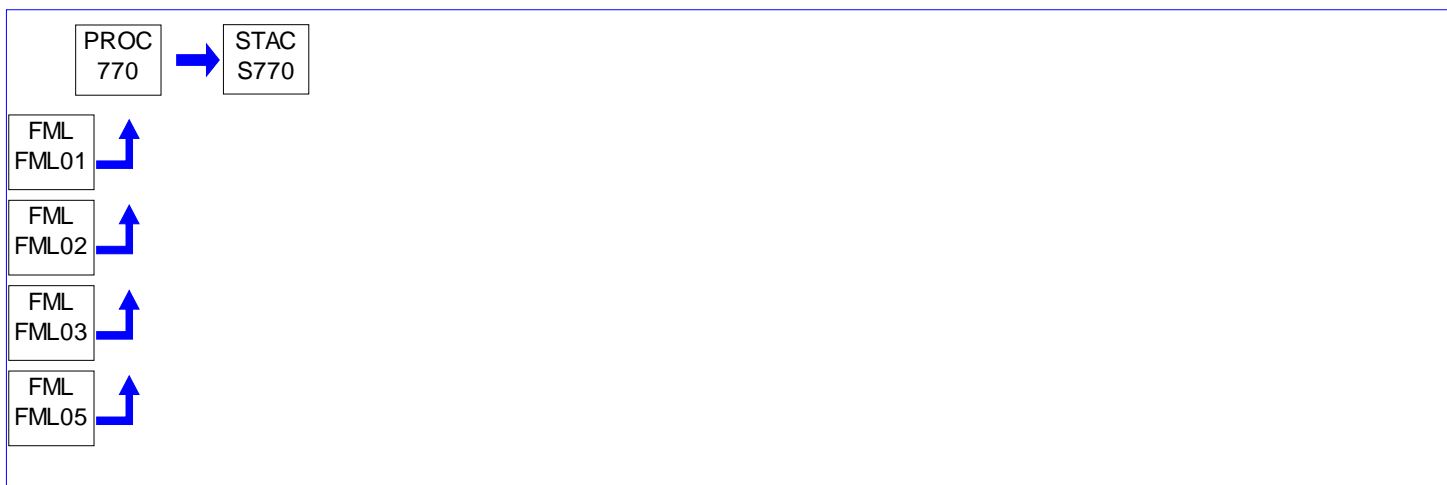
**I. RESTRICTIONS.****Emission Restriction(s).**

001 [25 Pa. Code §123.21]

General

The permittee may not permit the emission into the outdoor atmosphere of sulfur oxides from a source in a manner that the concentration of the sulfur oxides, expressed as SO₂, in the effluent gas exceeds 500 parts per million, by volume, dry basis.

Operation Hours Restriction(s).

002 [25 Pa. Code §127.441]

Operating permit terms and conditions.

[Additional authority for this permit condition is also derived from 25 Pa. Code § 127.512(h)]

(a) For those reciprocating internal combustion engine (RICE) identified under Source ID 770 that have a site rating of more than 100 brake HP (and a displacement of less than 30 liters per cylinder), these RICE may NOT be used for the following purposes, which would otherwise be allowed under 40 CFR Part 63, Subpart ZZZZ, as specified in 40 CFR § 63.6640(f):

- (1) Emergency demand response.
- (2) Periods where there is a deviation of voltage or frequency.
- (3) Supplying power as part of a financial arrangement with another entity or to generate income.
- (4) Peak shaving.
- (5) Non-emergency demand response.

(b) Subject to the restrictions in paragraph (a) of this condition, the permittee shall operate the RICE identified under Source ID 770 that have a site rating of more than 100 brake HP (and a displacement of less than 30 liters per cylinder) only for the purposes allowed by 40 CFR § 63.6640(f) to render the fuel restrictions in 40 CFR § 63.6604(b) not applicable.

003 [25 Pa. Code §127.441]

Operating permit terms and conditions.

[Additional authority for this permit condition is also derived from 25 Pa. Code § 127.512(h) and 25 Pa. Code § 129.97(c)]

The permittee shall limit the hours of operation of each internal combustion engine identified under this Source ID to no more than 500 hours in any consecutive twelve (12) month period.

004 [40 CFR Part 63 NESHAPS for Source Categories §40 CFR 63.6625]

Subpart ZZZZ - National Emissions Standards for Hazardous Air Pollutants for Stationary Reciprocating Internal Combustion Engines

**SECTION D. Source Level Requirements****What are my monitoring, installation, operation, and maintenance requirements?**

For each RICE identified under Source ID 770, the permittee shall minimize the engine's time spent at idle during startup and minimize the engine's startup time to a period needed for appropriate and safe loading of the engine, not to exceed 30 minutes.

005 [40 CFR Part 63 NESHAPS for Source Categories §40 CFR 63.6640]**Subpart ZZZZ - National Emissions Standards for Hazardous Air Pollutants for Stationary Reciprocating Internal Combustion Engines****How do I demonstrate continuous compliance with the emission limitations, operating limitations, and other requirements?**

[Additional authority for this permit condition is also derived from 40 CFR § 63.6604]

(a) For those reciprocating internal combustion engines (RICE) identified under Source ID 770 that have a site rating of 100 brake HP or less (and a displacement of less than 30 liters per cylinder), to be considered an emergency engine for purposes of 40 CFR Part 63, Subpart ZZZZ, the permittee shall operate these (RICE) according to the requirements in the most recent version of 40 CFR § 63.6640(f).

(b) If the permittee does not operate these engines according to the requirements of 40 CFR § 63.6640(f), the engine will not be considered an emergency engine under 40 CFR Part 63, Subpart ZZZZ, and must meet all requirements for non-emergency engines.

006 [40 CFR Part 63 NESHAPS for Source Categories §40 CFR 63.6640]**Subpart ZZZZ - National Emissions Standards for Hazardous Air Pollutants for Stationary Reciprocating Internal Combustion Engines****How do I demonstrate continuous compliance with the emission limitations, operating limitations, and other requirements?**

For those reciprocating internal combustion engine (RICE) identified under Source ID 770 that have a site rating of more than 100 brake HP (and a displacement of less than 30 liters per cylinder), to be considered an emergency engine for purposes of 40 CFR Part 63, Subpart ZZZZ, the permittee shall operate these (RICE) according to the following requirements:

(a) There is no time limit on the use of these RICE in emergency situations for purposes of 40 CFR Part 63, Subpart ZZZZ compliance.

(b) These RICE may be operated for a maximum of 100 hours per calendar year for maintenance checks and readiness testing, provided that the tests are recommended by federal, state or local government, the manufacturer, the vendor, the regional transmission organization or equivalent balancing authority and transmission operator, or the insurance company associated with the engine. The permittee may petition for approval of additional hours to be used for maintenance checks and readiness testing, but a petition is not required if the permittee maintains records indicating that federal, state, or local standards require maintenance and testing of emergency RICE beyond 100 hours per calendar year.

(c) These RICE may be operated for up to 50 hours per calendar year in non-emergency situations as permitted by 40 CFR § 63.6640(f)(4). The 50 hours of operation in non-emergency situations are counted as part of the 100 hours per calendar year for maintenance checks and readiness testing provided in paragraph (b) of this condition.

II. TESTING REQUIREMENTS.

No additional testing requirements exist except as provided in other sections of this permit including Section B (Title V General Requirements).

III. MONITORING REQUIREMENTS.**# 007 [40 CFR Part 63 NESHAPS for Source Categories §40 CFR 63.6625]****Subpart ZZZZ - National Emissions Standards for Hazardous Air Pollutants for Stationary Reciprocating Internal Combustion Engines****What are my monitoring, installation, operation, and maintenance requirements?**

**SECTION D. Source Level Requirements**

[Additional authority for this permit condition is also derived from 25 Pa. Code § 129.97(c)]

The following condition is applicable to all RICE identified under Source ID 770: Each RICE shall be equipped with a functional, non-resettable hour meter to monitor the hours of operation of the RICE.

IV. RECORDKEEPING REQUIREMENTS.**# 008 [25 Pa. Code §127.441]****Operating permit terms and conditions.**

The permittee shall maintain up-to-date records of the sulfur content of the fuel used in sources covered under Source ID 770.

009 [25 Pa. Code §127.441]**Operating permit terms and conditions.**

[Additional authority for this permit condition is also derived from 25 Pa. Code § 129.97(c)]

The permittee shall record on a monthly basis the number of hours that each reciprocating internal combustion engine (RICE) identified under Source ID 770 operates in order to calculate the emissions of air pollutants and to demonstrate compliance with the operating hour restrictions.

010 [40 CFR Part 63 NESHAPS for Source Categories §40 CFR 63.6655]**Subpart ZZZZ - National Emissions Standards for Hazardous Air Pollutants for Stationary Reciprocating Internal Combustion Engines****What records must I keep?**

[Additional authority for this permit condition is also derived from 40 CFR § 63.6640]

(a) The permittee shall maintain the following records for each RICE:

- (1) Records of the occurrence and duration of each malfunction of operation (i.e., process equipment) and/or monitoring equipment.
- (2) Records of all required maintenance performed on each unit and on the monitoring equipment, including oil analysis and results.
- (3) Records of actions taken during periods of malfunction to minimize emissions in accordance with 40 CFR § 63.6605(b), including corrective actions to restore malfunctioning process and monitoring equipment to its normal or usual manner of operation.

(b) The permittee shall maintain records to demonstrate compliance with either of the following, for each RICE:

- (1) Operating and maintaining the stationary RICE according to the manufacturer's emission-related operation and maintenance instructions;
- (2) Operating and maintaining the stationary RICE according to a maintenance plan developed by the permittee such that it provides to the extent practicable for the maintenance and operation of the engine in a manner consistent with good air pollution control practice for minimizing emissions.

(c) The permittee must keep records of the hours of operation of each RICE identified under Source ID 770 that is recorded through a non-resettable hour meter, on an annual basis. The permittee must document how many hours are spent for emergency operation, including what classified the operation as an emergency, and how many hours are spent for non-emergency operation. If a RICE is rated at 100 bhp or less, and is used for the purposes specified under 40 CFR § 63.6640(f)(2)(ii) or (iii) or § 63.6640(f)(4)(ii), the permittee must keep records of the notification of the emergency situation, and the date, start time, and end time of engine operation for these purposes.

(d) If the permittee participates in an oil analysis program pursuant to 40 CFR § 63.6625(i), the permittee must keep records of the parameters that are analyzed as part of the program, the results of the analysis, and the oil changes for the

**SECTION D. Source Level Requirements**

engine. Otherwise, the permittee shall maintain the necessary documentation to demonstrate compliance with the oil change requirements identified under Work Practice Requirements, pursuant to 40 CFR § 63.6640.

011 [40 CFR Part 63 NESHAPS for Source Categories §40 CFR 63.6660]**Subpart ZZZZ - National Emissions Standards for Hazardous Air Pollutants for Stationary Reciprocating Internal Combustion Engines****In what form and how long must I keep my records?**

[Additional authority for this permit condition is also derived from 40 CFR § 63.10(b)(1)]

- (a) Records required for Source ID 770 shall be in a form suitable and readily available for expeditious review.
- (b) The permittee shall maintain each record for 5 years following the date of each occurrence, measurement, maintenance, corrective action, report, or record.
- (c) The permittee shall keep each record readily accessible in hard copy or electronic form for at least 5 years after the date of each occurrence, measurement, maintenance, corrective action, report, or record.

V. REPORTING REQUIREMENTS.**# 012 [40 CFR Part 63 NESHAPS for Source Categories §40 CFR 63.6640]****Subpart ZZZZ - National Emissions Standards for Hazardous Air Pollutants for Stationary Reciprocating Internal Combustion Engines****How do I demonstrate continuous compliance with the emission limitations, operating limitations, and other requirements?**

All deviations from applicable emission limitations or operating limitations in 40 CFR Part 63, Subpart ZZZZ, as set forth in this operating permit, shall be reported in the permittee's semiannual monitoring report required by Sections B and C of this operating permit.

VI. WORK PRACTICE REQUIREMENTS.**# 013 [40 CFR Part 63 NESHAPS for Source Categories §40 CFR 63.6625]****Subpart ZZZZ - National Emissions Standards for Hazardous Air Pollutants for Stationary Reciprocating Internal Combustion Engines****What are my monitoring, installation, operation, and maintenance requirements?**

[Additional authority for this permit condition is also derived from 40 CFR § 63.6605]

- (a) The permittee shall operate and maintain each RICE identified under Source ID 770 according to the manufacturer's emission-related written instructions or develop a source specific maintenance plan which must provide to the extent practicable for the maintenance and operation of the engine in a manner consistent with good air pollution control practice for minimizing emissions.
- (b) If the permittee participates in an oil analysis program pursuant to 40 CFR 63.6625(i), the analysis program must be part of the maintenance plan for each engine.

[Compliance with this streamlined condition also ensures compliance with 25 Pa. Code § 129.97(c)]

014 [40 CFR Part 63 NESHAPS for Source Categories §40 CFR 63.6640]**Subpart ZZZZ - National Emissions Standards for Hazardous Air Pollutants for Stationary Reciprocating Internal Combustion Engines****How do I demonstrate continuous compliance with the emission limitations, operating limitations, and other requirements?**

[Additional authority for this permit condition is also derived from 40 CFR § 63.6625]

- (a) The following requirements apply to all CI RICE identified under Source ID 770:

- (1) The permittee shall change the oil and filter in each unit every 500 hours of operation or annually, whichever

**SECTION D. Source Level Requirements**

comes first;

(2) The permittee shall inspect the air cleaner in each unit every 1,000 hours of operation or annually, whichever comes first, and replace as necessary; and,

(3) The permittee shall inspect all hoses and belts in each unit every 500 hours of operation or annually, whichever comes first, and replace as necessary.

(b) The following requirements apply to all spark ignited (SI) RICE identified under Source ID 770:

(1) The permittee shall change the oil and filter in each unit every 500 hours of operation or annually, whichever comes first;

(2) The permittee shall inspect the spark plugs in each unit every 1,000 hours of operation or annually, whichever comes first, and replace as necessary; and,

(3) The permittee shall inspect all hoses and belts in each unit every 500 hours of operation or annually, whichever comes first, and replace as necessary.

(c) The permittee has the option of utilizing an oil analysis program in order to extend the specified oil change requirements in paragraphs (a) and (b) above. The oil analysis must be performed at the same frequency specified for changing the oil. The analysis program must at a minimum analyze the following, such that the oil meets all applicable conditions:

(1) For CI RICE, the following three parameters:

(i) Total Base Number, such that it is greater than or equal to 30% of the Total Base Number of the oil when new;

(ii) Viscosity, such that it has not changed more than 20% from the viscosity of the oil when new; and,

(iii) Percent water content (by volume), such that it is not greater than 0.5.

(2) For SI RICE, the following three parameters:

(i) Total Acid Number, such that it is has not increased by more than 3.0 milligrams of potassium hydroxide (KOH) per gram from the Total Acid Number of the oil when new;

(ii) Viscosity, such that it has not changed more than 20% from the viscosity of the oil when new; and,

(iii) Percent water content (by volume), such that it is not greater than 0.5.

(d) If the permittee complies with all applicable parameters in paragraph (c) above, the permittee is not required to change the oil. If any of the parameters are exceeded, the permittee must change the oil within 2 business days of receiving the results of the analysis; if the engine is not in operation when the results of the analysis are received, the permittee must change the oil within 2 business days or before commencing operation, whichever is later.

VII. ADDITIONAL REQUIREMENTS.

015 [25 Pa. Code §127.441]

Operating permit terms and conditions.

Source ID 770 consists of the following sources:

DEP Unit Designation	Engine ID/ Location	Manufacturer/ Model	Construction Date	HP	Engine Type
RICE01	NAB Drever FCE - A3H2A	Cummins/4BT3.9	6/15/1990	102	CI

**SECTION D. Source Level Requirements**

RICE02	BUDA - A3N7	Allis Chalmers/6MO-893	<6/12/2006	250*	4SLB
RICE04	Cen. Maint. Gen. #1 - A4N99A	Briggs and Stratton/303442	<6/12/2006	16	4SLB
RICE05	Cen. Maint. Gen. #2 - A4N99B	Fairbank	<6/12/2006	11*	4SLB
RICE06	Cen. Maint. Gen. #3 - A4N99C	Tecumseh Eng/175023D	<6/12/2006	11*	4SLB
RICE09	Raw Water Substation Gen	Hercules Eng/CE4931431	<6/12/2006	46*	4SLB
RICE12	Brandywine Elect. Substation	O'Brian/OB8T-GA61	<6/12/2006	18*	4SLB

*HP rating is estimated based on most accurate data available.

016 [40 CFR Part 63 NESHAPS for Source Categories §40 CFR 63.6595]

Subpart ZZZZ - National Emissions Standards for Hazardous Air Pollutants for Stationary Reciprocating Internal Combustion Engines

When do I have to comply with this subpart?

- (a) All CI RICE identified under Source ID 770 shall comply with all applicable requirements no later than May 3, 2013.
- (b) All SI RICE identified under Source ID 770 shall comply with all applicable requirements no later than October 19, 2013.

***** Permit Shield in Effect. *****

**SECTION D. Source Level Requirements**

Source ID: C003

Source Name: A, B & D BAGHOUSES

Source Capacity/Throughput:

72.000 Lbs/HR

PARTICULATES

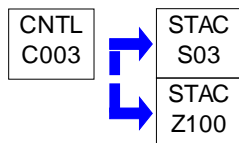
**I. RESTRICTIONS.****Emission Restriction(s).****# 001 [25 Pa. Code §127.441]****Operating permit terms and conditions.**

[Additional authority for this permit condition is also derived from 40 CFR § 63.10686]

No person may permit the emission into the outdoor atmosphere of filterable particulate matter, as measured by Method 5 or 5D of 40 CFR 60, Appendix A (or an equivalent method approved by the Department), from this source at any time, in excess of 0.0052 grains per dry standard cubic foot.

[Compliance with this streamlined condition also assures compliance with 25 Pa. Code § 123.13]

II. TESTING REQUIREMENTS.**# 002 [25 Pa. Code §127.441]****Operating permit terms and conditions.**

[Additional authority for this permit condition is derived from 25 Pa. Code § 129.100]

(a) The permittee shall perform a source test, in accordance with 25 Pa. Code Chapter 139 and the Department's Source Testing Manual (274-0300-002), no earlier than twenty-four (24) months prior to the expiration of this permit and the source test report must be submitted to the Department no later than six (6) months prior to the expiration of this permit. The source test shall, at a minimum, test for Total Particulate Matter, Nitrogen Oxides, Volatile Organic Compounds, Sulfur Dioxide, Carbon Monoxide, Cadmium, Chromium, Lead, Manganese, Nickel, and Arsenic.

(b) The test(s) shall be conducted while the source(s) is operating at maximum routine operating conditions or under such other conditions, within the capacity of the equipment, as may be requested by the Department.

(c) At least ninety (90) days prior to the test, the permittee shall submit to the Department for approval one paper copy plus one electronic copy to both the AQ Program Manager for the Southeast Regional Office and the PSIMS Administrator in Central Office the procedures for the test and a sketch with dimensions indicating the location of sampling ports and other data to ensure the collection of representative samples.

(d) At least thirty (30) days prior to the test, the AQ Program Manager for the Southeast Regional Office and the PSIMS Administrator in Central Office shall be informed of the date and time of the test.

(e) Within sixty (60) days after the source test(s) and no later than six (6) months prior to the expiration of this permit, the permittee shall submit one paper copy plus one electronic copy of the source test report, including all operating conditions, to both the AQ Program Manager for the Southeast Regional Office and the PSIMS Administrator in Central Office.

(f) The Department reserves the right to establish and impose more stringent pollution emission limits than those stated in this section, based on the test results from each source test performed as specified.

(g) In the event that any of the above deadlines cannot be met, the permittee may request an extension for the due date(s) in writing and include a justification for the extension. The Department may grant an extension for a reasonable cause.

**SECTION D. Source Level Requirements**

(h) Any questions or concerns about source testing submissions can be sent to RA-EPstacktesting@pa.gov and the PSIMS Administrator will address them. The following are the mail and email addresses for the AQ Program Manager for the Southeast Regional Office and the PSIMS Administrator in Central Office:

Central Office
 Pennsylvania Department of Environmental Protection
 Attn: PSIMS Administrator
 P.O. Box 8468
 Harrisburg, PA 17105-8468
 RA-EPstacktesting@pa.gov

Southeast Region
 Pennsylvania Department of Environmental Protection
 Attn: Air Quality Program Manager
 2 East Main Street
 Norristown, PA 19401
 RA-EPSEstacktesting@pa.gov

III. MONITORING REQUIREMENTS.**# 003 [25 Pa. Code §127.441]****Operating permit terms and conditions.**

[Additional authority for this permit condition is also derived from 40 CFR § 64.3 and § 64.6]

The permittee shall use the approved means or devices listed below to measure the applicable process parameters or indicators:

- (a) Differential pressure gauge, manometer or other device approved by the Department;
- (b) A device approved by the Department and maintained to provide accurate visible emissions measurements, or observers, trained and qualified to measure visible emissions with the naked eye or with the aid of any devices approved by the Department.

004 [25 Pa. Code §127.441]**Operating permit terms and conditions.**

[Additional authority for this permit condition is also derived from 40 CFR § 64.3 and § 64.6]

The permittee shall conduct monitoring of the following process parameters or indicators, when operating:

- (a) Static pressure differential on a daily basis, when operating;
- (b) Effective April 21, 2008, visible emissions observations on a daily basis, when operating.

005 [25 Pa. Code §127.441]**Operating permit terms and conditions.**

[Additional authority for this permit condition is also derived from 40 CFR § 64.3 and § 64.6]

The permittee shall use the following approved period over which discrete data points for approved process parameters of indicators will be collected and averaged for the purpose of determining an excursion:

- (a) The pressure differential shall be monitored daily;
- (b) Effective April 21, 2008, an EPA Reference Method (RM) 22 visible emissions observation shall be performed daily.

006 [25 Pa. Code §127.441]**Operating permit terms and conditions.**

[Additional authority for this permit condition is also derived from 40 CFR § 64.3 and § 64.6]

**SECTION D. Source Level Requirements**

The permittee shall use the following approved process parameters or indicators to obtain data and monitor the emission control equipment performance:

- (a) Static pressure differential;
- (b) Effective April 21, 2008, visible emissions observation.

IV. RECORDKEEPING REQUIREMENTS.**# 007 [25 Pa. Code §127.441]****Operating permit terms and conditions.**

[Additional authority for this permit condition is also derived from 40 CFR § 64.9]

The permittee shall record all excursions and corrective actions taken in response to an excursion and the time elapsed until the corrective actions have been taken.

008 [25 Pa. Code §127.441]**Operating permit terms and conditions.**

[Additional authority for this permit condition is also derived from 40 CFR § 64.9]

The permittee shall record all inspections, repairs and maintenance performed on the monitoring equipment.

009 [25 Pa. Code §127.441]**Operating permit terms and conditions.**

[Additional authority for this permit condition is also derived from 40 CFR § 70.6(a)(3)(ii)(B)]

The permittee shall keep records for a period of five (5) years and make the records available to the Department upon request.

010 [25 Pa. Code §127.441]**Operating permit terms and conditions.**

[Additional authority for this permit condition is also derived from 40 CFR § 64.3 and § 64.6]

The permittee shall maintain records of all monitoring downtime incidents (other than downtime associated with zero and span or other daily calibration checks, if applicable). The permittee shall also record the dates, times and durations, possible causes and corrective actions taken for the incidents.

011 [25 Pa. Code §127.441]**Operating permit terms and conditions.**

[Additional authority for this permit condition is also derived from 40 CFR § 64.9]

The permittee shall record the following approved process parameters or indicators using approved data collection devices:

- (a) Static pressure differential on a daily basis, when operating;
- (b) Effective April 21, 2008, visible emissions observation on a daily basis, when operating per RM-22 visible emission observations.
- (c) Effective April 21, 2008, observed visible emissions shall be noted and proper corrective actions shall be initiated within the next working day.

V. REPORTING REQUIREMENTS.**# 012 [25 Pa. Code §127.441]****Operating permit terms and conditions.**

[Additional authority for this permit condition is also derived from 40 CFR § 64.9 and § 70.6(a)(3)(iii)(A)]

- (a) Failure to take corrective actions within the next working day shall constitute as an excursion.

**SECTION D. Source Level Requirements**

(b) The permittee shall report all excursions and corrective actions taken, the dates, times, durations and possible causes for the excursion, every six (6) months in the semi-annual and annual compliance certifications, as per Section C, Condition #015.

013 [25 Pa. Code §127.441]**Operating permit terms and conditions.**

[Additional authority for this permit condition is also derived from 40 CFR § 64.9]

The permittee shall report monitoring downtime incidents (other than downtime associated with zero and span or other daily calibration checks, if applicable), their dates, times and durations, possible causes and corrective actions taken, every six (6) months in the semi-annual and annual compliance certifications, as per Section C, Condition #015.

VI. WORK PRACTICE REQUIREMENTS.**# 014 [25 Pa. Code §127.441]****Operating permit terms and conditions.**

[Additional authority for this permit condition is also derived from 40 CFR § 64.3]

The permittee shall utilize approved QA/QC practices that are adequate to ensure validity of data and proper performance of the devices.

(a) For future monitoring devices requested by the Department, the permittee shall, for the approved devices, install sensors at locations approved by the Department for obtaining data that are representative of the monitored indicator.

(b) The permittee shall develop verification procedures to confirm the operational status of new or modified monitoring equipment prior to commencement of the monitoring process.

(c) The permittee shall periodically check the monitoring equipment (i.e. magnehelic gauges) for accuracy, taking into account good maintenance practices and the manufacturer's specifications.

015 [25 Pa. Code §127.441]**Operating permit terms and conditions.**

On a monthly basis, the permittee shall conduct an operational status inspection of all equipment that is important to the performance of the capture system (i.e., pressure sensors, dampers and damper switches). The inspection shall include observations of the physical appearance of the equipment (e.g., presence of holes in duct work or hoods, flow constrictions caused by dents or accumulated dust in duct work, fan erosion, etc.). All deficiencies shall be noted and proper maintenance shall be initiated within the next working day.

016 [25 Pa. Code §127.441]**Operating permit terms and conditions.**

The permittee shall maintain all monitoring equipment and stock parts necessary for routine repairs on site.

017 [25 Pa. Code §127.441]**Operating permit terms and conditions.**

The permittee shall ensure that at least 90% of the monitoring data has been properly and accurately collected.

018 [25 Pa. Code §127.441]**Operating permit terms and conditions.**

(a) The permittee shall ensure that the maximum pressure drop across each of these baghouses shall not exceed 10.0 inches water gauge (w.g.).

(b) A pressure drop excursion will require the permittee to conduct an inspection, make corrective actions, and submit a report in the semi-annual and annual compliance certifications, as per Section C, Condition #015.

**SECTION D. Source Level Requirements****VII. ADDITIONAL REQUIREMENTS.****# 019 [25 Pa. Code §127.441]****Operating permit terms and conditions.**

[Additional authority for this permit condition is also derived from 40 CFR § 64.8]

The permittee shall develop and implement a Quality Improvement Plan (QIP) as expeditiously as practicable if any of the following occurs:

- (a) For properly and accurately collected data, accumulated excursions exceed five percent (5%) of the data for static pressure and visible emissions.
- (b) Six (6) excursions for each parameter occurring in a six-month reporting period.
- (c) The Department determines after review of all reported information that the permittee has not responded acceptably to an excursion.

020 [25 Pa. Code §127.441]**Operating permit terms and conditions.**

[Additional authority for this permit condition is also derived from 40 CFR § 64.8]

In general, the QIP should be developed within sixty (60) calendar days and the permittee shall provide a copy of the QIP to the Department. Furthermore, the permittee shall notify the Department if the period for completing the improvements contained in the QIP exceeds one hundred-eighty (180) calendar days from the date on which the need to implement the QIP was determined.

021 [25 Pa. Code §127.441]**Operating permit terms and conditions.**

[Additional authority for this permit condition is also derived from 40 CFR § 64.9]

The permittee shall record actions taken to implement a QIP during a reporting period and all related actions including, but not limited to inspections, repairs and maintenance performed on the monitoring equipment.

022 [25 Pa. Code §127.441]**Operating permit terms and conditions.**

[Additional authority for this permit condition is also derived from 40 CFR § 64.8]

In accordance with 40 CFR § 64.8, the QIP shall include procedures for evaluating the control performance problems. Based on the results of the evaluation procedures, the permittee shall modify the QIP, and provide a copy to the Department, to include procedures for conducting more frequent or improved monitoring in conjunction with one or more of the following:

- (a) Improved preventive maintenance practices;
- (b) Process operation changes;
- (c) Appropriate improvements to control methods;
- (d) Other steps appropriate to correct performance.

023 [25 Pa. Code §127.441]**Operating permit terms and conditions.**

[Additional authority for this permit condition is also derived from 40 CFR § 64.8]

Following implementation of a QIP, the Department will require reasonable revisions to the QIP if the plan has failed to either:

- (a) Address the cause of the control device performance problem;
- (b) Provide adequate procedures for correcting control device performance problems as expeditiously as practicable in accordance with good air pollution control practices for minimizing emissions.

**SECTION D. Source Level Requirements**

024 [25 Pa. Code §127.441]

Operating permit terms and conditions.

[Additional authority for this permit condition is also derived from 40 CFR § 64.8]

Implementation of a QIP, shall not excuse the owner or operator of a source from compliance with any existing emission limitation or standard or any existing monitoring, testing, reporting or recordkeeping requirement that may apply under any federal, state, or local laws or any other applicable requirements under the Clean Air Act.

***** Permit Shield in Effect. *****

**SECTION D. Source Level Requirements**

Source ID: C012

Source Name: VERT BLASTER BAGHOUSE

Source Capacity/Throughput:

N/A

PARTICULATES

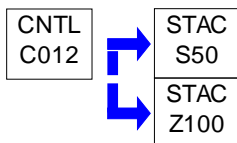
**I. RESTRICTIONS.****Emission Restriction(s).****# 001 [25 Pa. Code §127.441]****Operating permit terms and conditions.**

No person may permit the emission into the outdoor atmosphere of filterable particulate matter, as measured by Method 5 of 40 CFR 60, Appendix A (or an equivalent method approved by the Department), from this source at any time, in excess of 0.02 grains per dry standard cubic foot.

[Compliance with this streamlined condition also assures compliance with 25 Pa. Code § 123.13]

II. TESTING REQUIREMENTS.

No additional testing requirements exist except as provided in other sections of this permit including Section B (Title V General Requirements).

III. MONITORING REQUIREMENTS.**# 002 [25 Pa. Code §127.441]****Operating permit terms and conditions.**

The permittee shall monitor the static pressure differential across this baghouse, on a weekly basis, when operating.

IV. RECORDKEEPING REQUIREMENTS.**# 003 [25 Pa. Code §127.441]****Operating permit terms and conditions.**

The permittee shall maintain records of the static pressure differential across this baghouse on a weekly basis.

V. REPORTING REQUIREMENTS.

No additional reporting requirements exist except as provided in other sections of this permit including Section B (Title V General Requirements).

VI. WORK PRACTICE REQUIREMENTS.**# 004 [25 Pa. Code §127.441]****Operating permit terms and conditions.**

(a) The permittee shall ensure that the pressure drop this baghouse (Source ID: C012) shall not exceed 6.0 inches water gauge (w.g.).

(b) A pressure drop excursion will require the permittee to conduct an inspection, make corrective actions, and submit a report in the semiannual and annual compliance certifications as per Section C, Condition #015.

005 [25 Pa. Code §127.441]**Operating permit terms and conditions.**

The permittee shall keep on hand a sufficient quantity of spare fabric filter collector bags for this baghouse in order to be able to immediately replace any bags requiring replacement due to deterioration resulting from routine operation of the

**SECTION D. Source Level Requirements**

source and the control device.

VII. ADDITIONAL REQUIREMENTS.

No additional requirements exist except as provided in other sections of this permit including Section B (Title V General Requirements).

***** Permit Shield in Effect. *****

**SECTION D. Source Level Requirements**

Source ID: C017

Source Name: SOUTH STEEL YARD BAGHOUSE

Source Capacity/Throughput:

N/A

PARTICULATES

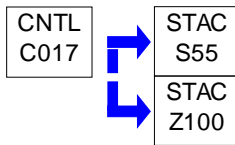
**I. RESTRICTIONS.****Emission Restriction(s).**

001 [25 Pa. Code §123.13]

Processes

The permittee may not permit the emission into the outdoor atmosphere of filterable particulate matter, as measured by Method 5 of 40 CFR 60, Appendix A (or an equivalent method approved by the Department), in a manner that the concentration of particulate matter in the effluent gas exceeds 0.04 grains per dry standard cubic foot.

II. TESTING REQUIREMENTS.

No additional testing requirements exist except as provided in other sections of this permit including Section B (Title V General Requirements).

III. MONITORING REQUIREMENTS.

002 [25 Pa. Code §127.441]

Operating permit terms and conditions.

The permittee shall monitor the static pressure differential across this baghouse on a weekly basis, when operating.

IV. RECORDKEEPING REQUIREMENTS.

003 [25 Pa. Code §127.441]

Operating permit terms and conditions.

The permittee shall maintain records of the static pressure differential across this baghouse on a weekly basis.

V. REPORTING REQUIREMENTS.

No additional reporting requirements exist except as provided in other sections of this permit including Section B (Title V General Requirements).

VI. WORK PRACTICE REQUIREMENTS.

004 [25 Pa. Code §127.441]

Operating permit terms and conditions.

(a) The permittee shall ensure that the maximum pressure drop across this baghouse shall not exceed 8.0 inches water gauge (w.g.).

(b) A pressure drop excursion will require the permittee to conduct an inspection, make corrective actions, and submit a report in the semiannual and annual compliance certifications as per Section C, Condition #015.

VII. ADDITIONAL REQUIREMENTS.

005 [25 Pa. Code §127.441]

Operating permit terms and conditions.

The permittee shall keep on hand a sufficient quantity of spare fabric filter collector bags for this baghouse in order to be able to immediately replace any bags requiring replacement due to deterioration resulting from routine operation of the

**SECTION D. Source Level Requirements**

source and the control device.

***** Permit Shield in Effect. *****

**SECTION D. Source Level Requirements**

Source ID: C090

Source Name: CANOPY SYS. BAGHOUSE "E"

Source Capacity/Throughput:

71.300 Lbs/HR

PARTICULATES

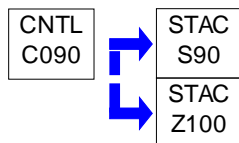
**I. RESTRICTIONS.****Emission Restriction(s).****# 001 [25 Pa. Code §127.441]****Operating permit terms and conditions.**

[Additional authority for this permit condition is also derived from 25 Pa. Code § 127.512(h) and 40 CFR § 63.10686]

The permittee shall not permit the emission into the outdoor atmosphere of filterable particulate matter, as measured by Method 5 or 5D of 40 CFR 60, Appendix A (or an equivalent method approved by the Department), from the main Baghouse "E" (Source ID: C090) in a manner that the concentration of particulate matter in the effluent gas exceeds 0.0052 grain per dry standard cubic foot.

[Compliance with this streamlined condition also assures compliance with 25 Pa. Code § 123.13]

II. TESTING REQUIREMENTS.**# 002 [25 Pa. Code §127.441]****Operating permit terms and conditions.**

[Additional authority for this permit condition is derived from 25 Pa. Code § 129.100]

(a) The permittee shall perform a source test, in accordance with 25 Pa. Code Chapter 139 and the Department's Source Testing Manual (274-0300-002), no earlier than twenty-four (24) months prior to the expiration of this permit and the source test report must be submitted to the Department no later than six (6) months prior to the expiration of this permit. The source test shall, at a minimum, test for Total Particulate Matter, Nitrogen Oxides, Volatile Organic Compounds, Sulfur Dioxide, Carbon Monoxide, Cadmium, Chromium, Lead, Manganese, Nickel, and Arsenic.

(b) The test(s) shall be conducted while the source(s) is operating at maximum routine operating conditions or under such other conditions, within the capacity of the equipment, as may be requested by the Department.

(c) At least ninety (90) days prior to the test, the permittee shall submit to the Department for approval one paper copy plus one electronic copy to both the AQ Program Manager for the Southeast Regional Office and the PSIMS Administrator in Central Office the procedures for the test and a sketch with dimensions indicating the location of sampling ports and other data to ensure the collection of representative samples.

(d) At least thirty (30) days prior to the test, the AQ Program Manager for the Southeast Regional Office and the PSIMS Administrator in Central Office shall be informed of the date and time of the test.

(e) Within sixty (60) days after the source test(s) and no later than six (6) months prior to the expiration of this permit, the permittee shall submit one paper copy plus one electronic copy of the source test report, including all operating conditions, to both the AQ Program Manager for the Southeast Regional Office and the PSIMS Administrator in Central Office.

(f) The Department reserves the right to establish and impose more stringent pollution emission limits than those stated in this section, based on the test results from each source test performed as specified.

(g) In the event that any of the above deadlines cannot be met, the permittee may request an extension for the due date(s) in writing and include a justification for the extension. The Department may grant an extension for a reasonable cause.

**SECTION D. Source Level Requirements**

(h) Any questions or concerns about source testing submissions can be sent to RA-EPstacktesting@pa.gov and the PSIMS Administrator will address them. The following are the mail and email addresses for the AQ Program Manager for the Southeast Regional Office and the PSIMS Administrator in Central Office:

Central Office
 Pennsylvania Department of Environmental Protection
 Attn: PSIMS Administrator
 P.O. Box 8468
 Harrisburg, PA 17105-8468
 RA-EPstacktesting@pa.gov

Southeast Region
 Pennsylvania Department of Environmental Protection
 Attn: Air Quality Program Manager
 2 East Main Street
 Norristown, PA 19401
 RA-EPSEstacktesting@pa.gov

III. MONITORING REQUIREMENTS.**# 003 [25 Pa. Code §127.441]****Operating permit terms and conditions.**

[Additional authority for this permit condition is also derived from 40 CFR § 64.3 and § 64.6]

The permittee shall use the approved means or devices listed below to measure the applicable process parameters or indicators:

- (a) Differential pressure gauge, manometer or other device approved by the Department;
- (b) A device approved by the Department and maintained to provide accurate visible emissions measurements, or observers, trained and qualified to measure visible emissions with the naked eye or with the aid of any devices approved by the Department.

004 [25 Pa. Code §127.441]**Operating permit terms and conditions.**

[Additional authority for this permit condition is also derived from 40 CFR § 64.3 and § 64.6]

The permittee shall conduct monitoring of the following process parameters or indicators, when operating:

- (a) Static pressure differential on a daily basis, when operating;
- (b) Effective April 21, 2008, visible emissions observations on a daily basis, when operating.

005 [25 Pa. Code §127.441]**Operating permit terms and conditions.**

[Additional authority for this permit condition is also derived from 40 CFR § 64.3 and § 64.6]

The permittee shall use the following approved period over which discrete data points for approved process parameters of indicators will be collected and averaged for the purpose of determining an excursion:

- (a) The pressure differential shall be monitored daily;
- (b) Effective April 21, 2008, an EPA Reference Method (RM) 22 visible emissions observation shall be performed daily.

006 [25 Pa. Code §127.441]**Operating permit terms and conditions.**

[Additional authority for this permit condition is also derived from 40 CFR § 64.3 and § 64.6]

**SECTION D. Source Level Requirements**

The permittee shall use the following approved process parameters or indicators to obtain data and monitor the emission control equipment performance:

- (a) Static pressure differential;
- (b) Effective April 21, 2008, visible emissions observation.

IV. RECORDKEEPING REQUIREMENTS.**# 007 [25 Pa. Code §127.441]****Operating permit terms and conditions.**

[Additional authority for this permit condition is also derived from 40 CFR § 64.9]

The permittee shall record all excursions and corrective actions taken in response to an excursion and the time elapsed until the corrective actions have been taken.

008 [25 Pa. Code §127.441]**Operating permit terms and conditions.**

[Additional authority for this permit condition is also derived from 40 CFR § 64.9]

The permittee shall record all inspections, repairs and maintenance performed on the monitoring equipment.

009 [25 Pa. Code §127.441]**Operating permit terms and conditions.**

[Additional authority for this permit condition is also derived from 40 CFR § 70.6(a)(3)(ii)(B)]

The permittee shall keep records for a period of five (5) years and make the records available to the Department upon request.

010 [25 Pa. Code §127.441]**Operating permit terms and conditions.**

[Additional authority for this permit condition is also derived from 40 CFR § 64.3 and § 64.6]

The permittee shall maintain records of all monitoring downtime incidents (other than downtime associated with zero and span or other daily calibration checks, if applicable). The permittee shall also record the dates, times and durations, possible causes and corrective actions taken for the incidents.

011 [25 Pa. Code §127.441]**Operating permit terms and conditions.**

[Additional authority for this permit condition is also derived from 40 CFR § 64.9]

The permittee shall record the following approved process parameters or indicators using approved data collection devices:

- (a) Static pressure differential on a daily basis, when operating;
- (b) Effective April 21, 2008, visible emissions observation on a daily basis, when operating per RM-22 visible emission observations.
- (c) Effective April 21, 2008, observed visible emissions shall be noted and proper corrective actions shall be initiated within the next working day.

V. REPORTING REQUIREMENTS.**# 012 [25 Pa. Code §127.441]****Operating permit terms and conditions.**

[Additional authority for this permit condition is also derived from 40 CFR § 64.9 and § 70.6(a)(3)(iii)(A)]

- (a) Failure to take corrective actions within the next working day shall constitute as an excursion.

**SECTION D. Source Level Requirements**

(b) The permittee shall report all excursions and corrective actions taken, the dates, times, durations and possible causes for the excursion, every six (6) months in the semi-annual and annual compliance certifications, as per Section C, Condition #015.

013 [25 Pa. Code §127.441]**Operating permit terms and conditions.**

[Additional authority for this permit condition is also derived from 40 CFR § 64.9]

The permittee shall report monitoring downtime incidents (other than downtime associated with zero and span or other daily calibration checks, if applicable), their dates, times and durations, possible causes and corrective actions taken, every six (6) months in the semi-annual and annual compliance certifications, as per Section C, Condition #015.

VI. WORK PRACTICE REQUIREMENTS.**# 014 [25 Pa. Code §127.441]****Operating permit terms and conditions.**

[Additional authority for this permit condition is also derived from 40 CFR § 64.3]

The permittee shall utilize approved QA/QC practices that are adequate to ensure validity of data and proper performance of the devices.

(a) For future monitoring devices requested by the Department, the permittee shall, for the approved devices, install sensors at locations approved by the Department for obtaining data that are representative of the monitored indicator.

(b) The permittee shall develop verification procedures to confirm the operational status of new or modified monitoring equipment prior to commencement of the monitoring process.

(c) The permittee shall periodically check the monitoring equipment (i.e. magnehelic gauges) for accuracy, taking into account good maintenance practices and the manufacturer's specifications.

015 [25 Pa. Code §127.441]**Operating permit terms and conditions.**

On a monthly basis, the permittee shall conduct an operational status inspection of all equipment that is important to the performance of the capture system (i.e., pressure sensors, dampers and damper switches). The inspection shall include observations of the physical appearance of the equipment (e.g., presence of holes in duct work or hoods, flow constrictions caused by dents or accumulated dust in duct work, fan erosion, etc.). All deficiencies shall be noted and proper maintenance shall be initiated within the next working day.

016 [25 Pa. Code §127.441]**Operating permit terms and conditions.**

The permittee shall maintain all monitoring equipment and stock parts necessary for routine repairs on site.

017 [25 Pa. Code §127.441]**Operating permit terms and conditions.**

The permittee shall ensure that at least 90% of the monitoring data has been properly and accurately collected.

018 [25 Pa. Code §127.441]**Operating permit terms and conditions.**

(a) The permittee shall ensure that that maximum pressure drop across this baghouse shall not exceed 10.0 inches water gauge (w.g.).

(b) A pressure differential excursion will require the permittee to conduct an inspection, make corrective actions, and submit a report in the semiannual and annual compliance certifications as per Section C, Condition #015.

**SECTION D. Source Level Requirements****VII. ADDITIONAL REQUIREMENTS.****# 019 [25 Pa. Code §127.441]****Operating permit terms and conditions.**

[Additional authority for this permit condition is also derived from 40 CFR § 64.8]

The permittee shall develop and implement a Quality Improvement Plan (QIP) as expeditiously as practicable if any of the following occurs:

- (a) For properly and accurately collected data, accumulated excursions exceed five percent (5%) of the data for static pressure and visible emissions.
- (b) Six (6) excursions for each parameter occurring in a six-month reporting period.
- (c) The Department determines after review of all reported information that the permittee has not responded acceptably to an excursion.

020 [25 Pa. Code §127.441]**Operating permit terms and conditions.**

[Additional authority for this permit condition is also derived from 40 CFR § 64.8]

In general, the QIP should be developed within sixty (60) calendar days and the permittee shall provide a copy of the QIP to the Department. Furthermore, the permittee shall notify the Department if the period for completing the improvements contained in the QIP exceeds one hundred-eighty (180) calendar days from the date on which the need to implement the QIP was determined.

021 [25 Pa. Code §127.441]**Operating permit terms and conditions.**

[Additional authority for this permit condition is also derived from 40 CFR § 64.9]

The permittee shall record actions taken to implement a QIP during a reporting period and all related actions including, but not limited to inspections, repairs and maintenance performed on the monitoring equipment.

022 [25 Pa. Code §127.441]**Operating permit terms and conditions.**

[Additional authority for this permit condition is also derived from 40 CFR § 64.8]

In accordance with 40 CFR § 64.8, the QIP shall include procedures for evaluating the control performance problems. Based on the results of the evaluation procedures, the permittee shall modify the QIP, and provide a copy to the Department, to include procedures for conducting more frequent or improved monitoring in conjunction with one or more of the following:

- (a) Improved preventive maintenance practices;
- (b) Process operation changes;
- (c) Appropriate improvements to control methods;
- (d) Other steps appropriate to correct performance.

023 [25 Pa. Code §127.441]**Operating permit terms and conditions.**

[Additional authority for this permit condition is also derived from 40 CFR § 64.8]

Following implementation of a QIP, the Department will require reasonable revisions to the QIP if the plan has failed to either:

- (a) Address the cause of the control device performance problem;
- (b) Provide adequate procedures for correcting control device performance problems as expeditiously as practicable in accordance with good air pollution control practices for minimizing emissions.

**SECTION D. Source Level Requirements****# 024 [25 Pa. Code §127.441]****Operating permit terms and conditions.**

[Additional authority for this permit condition is also derived from 40 CFR § 64.8]

Implementation of a QIP, shall not excuse the owner or operator of a source from compliance with any existing emission limitation or standard or any existing monitoring, testing, reporting or recordkeeping requirement that may apply under any federal, state, or local laws or any other applicable requirements under the Clean Air Act.

***** Permit Shield in Effect. *****

**SECTION D. Source Level Requirements**

Source ID: C101

Source Name: ICA HOT TOP CUT STATION BAGHOUSE

Source Capacity/Throughput:

N/A

PARTICULATES

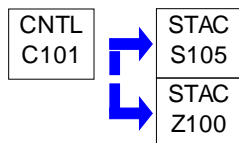
**I. RESTRICTIONS.****Emission Restriction(s).**

001 [25 Pa. Code §123.13]

Processes

No person may permit the emission into the outdoor atmosphere of filterable particulate matter, as measured by Method 5 of 40 CFR 60, Appendix A (or an equivalent method approved by the Department), from this source at any time, in excess of 0.04 grains per dry standard cubic foot.

II. TESTING REQUIREMENTS.

No additional testing requirements exist except as provided in other sections of this permit including Section B (Title V General Requirements).

III. MONITORING REQUIREMENTS.

002 [25 Pa. Code §127.441]

Operating permit terms and conditions.

The permittee shall monitor the static pressure differential across this baghouse on a weekly basis, when operating.

IV. RECORDKEEPING REQUIREMENTS.

003 [25 Pa. Code §127.441]

Operating permit terms and conditions.

The permittee shall maintain records of the static pressure differential across this baghouse, on a weekly basis.

V. REPORTING REQUIREMENTS.

No additional reporting requirements exist except as provided in other sections of this permit including Section B (Title V General Requirements).

VI. WORK PRACTICE REQUIREMENTS.

004 [25 Pa. Code §127.441]

Operating permit terms and conditions.

(a) The permittee shall ensure that the maximum pressure drop averaged across the compartments of this baghouse shall not exceed 10.0 inches water gauge (w.g.).

(b) A pressure drop excursion will require the permittee to conduct an inspection, make corrective actions, and submit a report in the semi-annual and annual compliance certifications, as per Section C, Condition #015.

005 [25 Pa. Code §127.441]

Operating permit terms and conditions.

The permittee shall keep on hand a sufficient quantity of spare fabric filter collector bags for this baghouse in order to be able to immediately replace any bags requiring replacement due to deterioration resulting from routine operation of the source(s) and the control device(s).



SECTION D. Source Level Requirements

VII. ADDITIONAL REQUIREMENTS.

No additional requirements exist except as provided in other sections of this permit including Section B (Title V General Requirements).

***** Permit Shield in Effect. *****

**SECTION D. Source Level Requirements**

Source ID: C105

Source Name: CASTER BAGHOUSE

Source Capacity/Throughput:

N/A

PARTICULATES

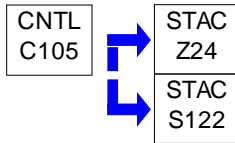
**I. RESTRICTIONS.****Emission Restriction(s).**

001 [25 Pa. Code §123.13]

Processes

The permittee may not permit the emission into the outdoor atmosphere of filterable particulate matter, as measured by Method 5 of 40 CFR 60, Appendix A (or an equivalent method approved by the Department), from this source at any time, in excess of 0.04 grains per dry standard cubic foot.

II. TESTING REQUIREMENTS.

No additional testing requirements exist except as provided in other sections of this permit including Section B (Title V General Requirements).

III. MONITORING REQUIREMENTS.

002 [25 Pa. Code §127.441]

Operating permit terms and conditions.

The permittee shall monitor the static pressure differential across this baghouse, on a weekly basis, when operating.

IV. RECORDKEEPING REQUIREMENTS.

003 [25 Pa. Code §127.441]

Operating permit terms and conditions.

The permittee shall maintain records of the static pressure differential across this baghouse, on a weekly basis.

V. REPORTING REQUIREMENTS.

No additional reporting requirements exist except as provided in other sections of this permit including Section B (Title V General Requirements).

VI. WORK PRACTICE REQUIREMENTS.

004 [25 Pa. Code §127.441]

Operating permit terms and conditions.

(a) The permittee shall ensure that the maximum pressure drop across this baghouse shall not exceed 10.0 inches water gauge (w.g.).

(b) A pressure drop excursion will require the permittee to conduct an inspection, make corrective actions, and submit a report in the semiannual and annual compliance certifications as per Section C, Condition #015.

005 [25 Pa. Code §127.441]

Operating permit terms and conditions.

The permittee shall keep on hand a sufficient quantity of spare fabric filter collector bags for this baghouse in order to be able to immediately replace any bags requiring replacement due to deterioration resulting from routine operation of the source and the control device.



SECTION D. Source Level Requirements

VII. ADDITIONAL REQUIREMENTS.

No additional requirements exist except as provided in other sections of this permit including Section B (Title V General Requirements).

***** Permit Shield in Effect. *****

**SECTION D. Source Level Requirements**

Source ID: C106

Source Name: MOLD GRINDING BAGHOUSE

Source Capacity/Throughput:

N/A

PARTICULATES

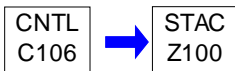
**I. RESTRICTIONS.****Emission Restriction(s).****# 001 [25 Pa. Code §123.13]****Processes**

No person may permit the emission into the outdoor atmosphere of filterable particulate matter, as measured by Method 5 of 40 CFR 60, Appendix A (or an equivalent method approved by the Department), from this source at any time, in excess of 0.04 grains per dry standard cubic foot.

II. TESTING REQUIREMENTS.

No additional testing requirements exist except as provided in other sections of this permit including Section B (Title V General Requirements).

III. MONITORING REQUIREMENTS.**# 002 [25 Pa. Code §127.441]****Operating permit terms and conditions.**

The permittee shall monitor the static pressure differential across this baghouse on a weekly basis, when operating.

IV. RECORDKEEPING REQUIREMENTS.**# 003 [25 Pa. Code §127.441]****Operating permit terms and conditions.**

The permittee shall maintain records of the static pressure differential across this baghouse, on a weekly basis.

V. REPORTING REQUIREMENTS.

No additional reporting requirements exist except as provided in other sections of this permit including Section B (Title V General Requirements).

VI. WORK PRACTICE REQUIREMENTS.**# 004 [25 Pa. Code §127.441]****Operating permit terms and conditions.**

(a) The permittee shall ensure that the maximum pressure drop across this baghouse shall not exceed 7.0 inches water gauge (w.g.).

(b) A pressure drop excursion will require the permittee to conduct an inspection, make corrective actions, and submit a report, in the semiannual and annual compliance certifications, as per Section C, Condition #015.

005 [25 Pa. Code §127.441]**Operating permit terms and conditions.**

The permittee shall keep on hand a sufficient quantity of spare fabric filter collector bags for this baghouse in order to be able to immediately replace any bags requiring replacement due to deterioration resulting from routine operation of the source and the control device.



SECTION D. Source Level Requirements

VII. ADDITIONAL REQUIREMENTS.

No additional requirements exist except as provided in other sections of this permit including Section B (Title V General Requirements).

***** Permit Shield in Effect. *****

**SECTION D. Source Level Requirements**

Source ID: C113

Source Name: HORIZ GRIT BLSTR BAGHOUSE

Source Capacity/Throughput:

N/A

PARTICULATES

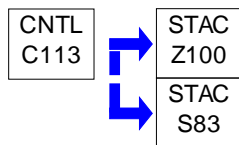
**I. RESTRICTIONS.****Emission Restriction(s).****# 001 [25 Pa. Code §127.441]****Operating permit terms and conditions.**

No person may permit the emission into the outdoor atmosphere of filterable particulate matter, as measured by Method 5 of 40 CFR 60, Appendix A (or an equivalent method approved by the Department), from this source at any time, in excess of 0.02 grains per dry standard cubic foot.

[Compliance with this streamlined condition also assures compliance with 25 Pa. Code § 123.13]

II. TESTING REQUIREMENTS.

No additional testing requirements exist except as provided in other sections of this permit including Section B (Title V General Requirements).

III. MONITORING REQUIREMENTS.**# 002 [25 Pa. Code §127.441]****Operating permit terms and conditions.**

The permittee shall monitor the static pressure differential across this baghouse, on a weekly basis, when operating.

IV. RECORDKEEPING REQUIREMENTS.**# 003 [25 Pa. Code §127.441]****Operating permit terms and conditions.**

The permittee shall maintain records of the static pressure differential across this baghouse on a weekly basis.

V. REPORTING REQUIREMENTS.

No additional reporting requirements exist except as provided in other sections of this permit including Section B (Title V General Requirements).

VI. WORK PRACTICE REQUIREMENTS.**# 004 [25 Pa. Code §127.441]****Operating permit terms and conditions.**

(a) The permittee shall ensure that the pressure drop across this baghouse (Source ID: C113) shall not exceed 6.0 inches water gauge (w.g.).

(b) A pressure drop excursion will require the permittee to conduct an inspection, make corrective actions, and submit a report in the semiannual and annual compliance certifications, as per Section C, Condition #015.

005 [25 Pa. Code §127.441]**Operating permit terms and conditions.**

The permittee shall keep on hand a sufficient quantity of spare fabric filter collector bags for this baghouse in order to be able to immediately replace any bags requiring replacement due to deterioration resulting from routine operation of the

**SECTION D. Source Level Requirements**

source and the control device.

VII. ADDITIONAL REQUIREMENTS.

No additional requirements exist except as provided in other sections of this permit including Section B (Title V General Requirements).

***** Permit Shield in Effect. *****

**SECTION D. Source Level Requirements**

Source ID: C141

Source Name: CAMFIL-FARR DUST COLLECTOR

Source Capacity/Throughput:

N/A

PARTICULATES

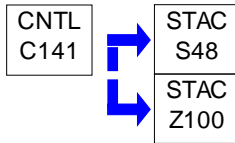
**I. RESTRICTIONS.****Emission Restriction(s).****# 001 [25 Pa. Code §127.441]****Operating permit terms and conditions.**

[Additional authority for this permit condition is also derived from 25 Pa. Code § 127.512(h)]

The permittee may not permit the emission into the outdoor atmosphere of filterable particulate matter, from this baghouse, as measured by Method 5 of 40 CFR 60, Appendix A (or an equivalent method approved by the Department), in a manner that the concentration of particulate matter in the effluent gas exceeds 0.01 grain per dry standard cubic foot.

[Compliance with this streamlined condition also assures compliance with 25 Pa. Code § 123.13]

II. TESTING REQUIREMENTS.

No additional testing requirements exist except as provided in other sections of this permit including Section B (Title V General Requirements).

III. MONITORING REQUIREMENTS.**# 002 [25 Pa. Code §127.441]****Operating permit terms and conditions.**

The permittee shall monitor the static pressure differential across this baghouse on a weekly basis, when operating.

IV. RECORDKEEPING REQUIREMENTS.**# 003 [25 Pa. Code §127.441]****Operating permit terms and conditions.**

The permittee shall maintain records of the static pressure differential across this baghouse on a weekly basis.

V. REPORTING REQUIREMENTS.

No additional reporting requirements exist except as provided in other sections of this permit including Section B (Title V General Requirements).

VI. WORK PRACTICE REQUIREMENTS.**# 004 [25 Pa. Code §127.441]****Operating permit terms and conditions.**

The permittee shall ensure that Camfil-Farr dust collector (Source ID: C141) shall be equipped with a pressure gauge to measure the pressure differential across the dust collector filter, in inches, water gauge (w.g.).

005 [25 Pa. Code §127.441]**Operating permit terms and conditions.**

(a) The permittee shall ensure that that maximum pressure drop across this baghouse shall not exceed 8.0 inches water gauge (w.g.).

**SECTION D. Source Level Requirements**

(b) A pressure drop excursion will require the permittee to conduct an inspection, make corrective actions, and submit a report in the semiannual and annual compliance certifications as per Section C, Condition #015.

006 [25 Pa. Code §127.441]**Operating permit terms and conditions.**

The permittee shall keep on hand a sufficient quantity of spare filter cartridges for this baghouse in order to be able to immediately replace any cartridges requiring replacement due to deterioration resulting from routine operation of the source and the control device.

VII. ADDITIONAL REQUIREMENTS.

No additional requirements exist except as provided in other sections of this permit including Section B (Title V General Requirements).

***** Permit Shield in Effect. *****



SECTION E. Alternative Operation Requirements.

No Alternative Operations exist for this Title V facility.

**SECTION F. Emission Restriction Summary.**

Source Id	Source Descriptor		
035	2-ARC BUILD. BOILERS-6.28MMBTU EACH		
Emission Limit			
1.200	Lbs/MMBTU		SOX
0.400	Lbs/MMBTU	particulate matter	TSP
055	ELECTRIC MELT SHOP BOILER		
Emission Limit			
19.620	Tons/Yr	Determined on a 12-month rolling period	NOX
1.200	Lbs/MMBTU		SOX
0.356	Lbs/MMBTU	Particulate Matter	TSP
104	\D\ ELECTRIC FURNACE		
Emission Limit			
34.100	Tons/Mth		NOX
340.600	Tons/Yr	Determined on a 12-month rolling period	NOX
500.000	PPMV	Determined on a dry volume basis	SOX
0.005	gr/DRY FT3		TSP
49.300	Tons/Mth		VOC
492.900	Tons/Yr	Determined on a 12-month rolling period	VOC
136	BATCH HT. TRT. FURNACES 2-8 & 10		
Emission Limit			
173.600	Tons/Yr	Determined on a 12-month rolling period	NOX
500.000	PPMV	Determined on a dry volume basis	SOX
0.040	gr/DRY FT3	Applies to filterable PM only	TSP
146A	145' NAB FURNACE (CHT)		
Emission Limit			
33.700	Tons/Yr	12 month rolling sum	NOX
500.000	PPMV	Determined on a dry volume basis	SOX
0.040	gr/DRY FT3	Applies to filterable PM only	TSP
146B	200' NAB FURNACE (CHT)		
Emission Limit			
30.600	Tons/Yr	12 month rolling sum	NOX
120.000	Lbs/MMCF		NOX
500.000	PPMV	Determined on a dry volume basis	SOX
0.040	gr/DRY FT3	Applies to filterable PM only	TSP
151	15 SOAKING PITS		
Emission Limit			
502.800	Tons/Yr	Determined on a 12-month rolling period	NOX
500.000	PPMV/PPMV	Determined on a dry volume basis	SOX
0.040	gr/DRY FT3	particulate matter	TSP

**SECTION F. Emission Restriction Summary.**

Source Id	Source Descriptor		
174	GREEN ANNEAL GRIT BLASTER & BAGHOUSE		
Emission Limit		Pollutant	
3.690	Lbs/Hr		TSP
16.160	Tons/Yr		TSP
176	VERT.BLAST CONT.FIN.& BAGHOUSE		
Emission Limit		Pollutant	
1.090	Lbs/Hr	particulate matter	TSP
4.090	Tons/Yr	particulate matter	TSP
182	ACA POWDER CUTTING & BAGHOUSE		
Emission Limit		Pollutant	
0.233	Tons/Yr		Hazardous Air Pollutants
0.010	gr/DRY FT3	Applies to filterable PM only	TSP
0.720	Lbs/Hr		TSP
3.130	Tons/Yr		TSP
183	MISC PROCS & GAS USE (10)		
Emission Limit		Pollutant	
1.200	Lbs/MMBTU	Applies to combustion units only	SOX
500.000	PPMV	Determined on a dry volume basis; applies to processes only	SOX
0.040	gr/DRY FT3	Applies to filterable PM only from processes only	TSP
190	BICKLEY FURNACE		
Emission Limit		Pollutant	
500.000	PPMV	Determined on a dry volume basis	SOX
0.040	gr/DRY FT3	Applies to filterable PM only	TSP
192	140M SAUDER FURNACE		
Emission Limit		Pollutant	
500.000	PPMV	Determined on a dry volume basis	SOX
0.040	gr/DRY FT3	Applies to filterable PM only	TSP
228	LADLE REFINER - FCE		
Emission Limit		Pollutant	
500.000	PPMV	Determined on a dry volume basis	SOX
229	LADLE PRE-HEATER		
Emission Limit		Pollutant	
500.000	PPMV	Determined on a dry volume basis	SOX
229A	LADLE PRE-HEATER (4575-10-B)		
Emission Limit		Pollutant	
4.290	Tons/Yr	Determined on a 12-month rolling period	CO
84.000	Lbs/MMCF	Lbs/MMcf of Natural Gas	CO

**SECTION F. Emission Restriction Summary.**

Source Id	Source Descriptor		
5.780	Tons/Yr	Determined on a 12-month rolling period	NOX
113.300	Lbs/MMCF	Lbs/MMcf of Natural Gas	NOX
500.000	PPMV	Determined on a dry volume basis	SOX
229B	LADLE PRE-HEATERS "B" AND "D"		
Emission Limit		Pollutant	
4.290	Tons/Yr	Determined on a 12-month rolling period; Per each ladle pre-heater	CO
84.000	Lbs/MMCF	Lbs/MMcf of Natural Gas; Per each ladle pre-heater	CO
5.780	Tons/Yr	Determined on a 12-month rolling period; Per each ladle pre-heater	NOX
113.300	Lbs/MMCF	Lbs/MMcf of Natural Gas; Per each ladle pre-heater	NOX
500.000	PPMV	Determined on a dry volume basis	SOX
230	VACUUM OXYGEN DECARBURIZATION (VOD)		
Emission Limit		Pollutant	
500.000	PPMV	Determined on a dry volume basis	SOX
231	EMS LADLE DRYER/PREHEATER		
Emission Limit		Pollutant	
500.000	PPMV	Determined on a dry volume basis	SOX
232	SLAG SKIMMING-VOD & BAGHOUSE		
Emission Limit		Pollutant	
500.000	PPMV	Determined on a dry volume basis	SOX
234	TEEMING PROCESS & BAGHOUSE		
Emission Limit		Pollutant	
500.000	PPMV	Determined on a dry volume basis	SOX
235	SLAB CUT-OFF TORCH & BAGHOUSE		
Emission Limit		Pollutant	
0.375	Lbs/Hr		Chromium Compounds
0.216	Lbs/Hr		Nickel Compounds
500.000	PPMV	Determined on a dry volume basis	SOX
237	CASTER DECK		
Emission Limit		Pollutant	
0.040	gr/DRY FT3	Applies to filterable PM only	TSP

**SECTION F. Emission Restriction Summary.**

Source Id	Source Description		
250	IDENTIFICATION MARKING		
Emission Limit		Pollutant	
9.400	Tons/Yr	Determined on a 12-month rolling basis	VOC
254	NICKEL PLATING LINE AND 2 SCRUBBERS		
Emission Limit		Pollutant	
0.040	gr/DRY FT3	particulate matter	TSP
258	HORIZONTAL GRIT BLASTER AND BAGHOUSE		
Emission Limit		Pollutant	
1.150	Lbs/Hr	particulate matter	TSP
4.310	Tons/Yr	12-month rolling sum	TSP
270	CONTINUOUS CASTING SPRAY CHAMBER		
Emission Limit		Pollutant	
0.040	gr/DRY FT3	particulate matter	TSP
9.020	Tons/Yr	Determined on a 12-month rolling period	VOC
768	EMER PUMP/GENERATOR (20 MM GAL RESERVIOR)		
Emission Limit		Pollutant	
500.000	PPMV	dry basis	SOX
769	NG EMERG ICU'S		
Emission Limit		Pollutant	
500.000	PPMV		SOX
0.040	gr/DRY FT3	Applies to filterable PM only	TSP
770	SMALL EMERGENCY GENERATORS/PUMPS		
Emission Limit		Pollutant	
500.000	PPMV		SOX
C003	A, B & D BAGHOUSES		
Emission Limit		Pollutant	
0.005	gr/DRY FT3	particulate matter	TSP
C012	VERT BLASTER BAGHOUSE		
Emission Limit		Pollutant	
0.020	gr/DRY FT3	particulate matter	TSP
C017	SOUTH STEEL YARD BAGHOUSE		
Emission Limit		Pollutant	
0.040	gr/DRY FT3	particulate matter	TSP

**SECTION F. Emission Restriction Summary.**

Source Id	Source Description		
C090	CANOPY SYS. BAGHOUSE "E"		
Emission Limit		Pollutant	
0.005	gr/DRY FT3	particulate matter	TSP
C101	ICA HOT TOP CUT STATION BAGHOUSE		
Emission Limit		Pollutant	
0.040	gr/DRY FT3	particulate matter	TSP
C105	CASTER BAGHOUSE		
Emission Limit		Pollutant	
0.040	gr/DRY FT3	particulate matter	TSP
C106	MOLD GRINDING BAGHOUSE		
Emission Limit		Pollutant	
0.040	gr/DRY FT3	particulate matter	TSP
C113	HORIZ GRIT BLSTR BAGHOUSE		
Emission Limit		Pollutant	
0.020	gr/DRY FT3	particulate matter	TSP
C141	CAMFIL-FARR DUST COLLECTOR		
Emission Limit		Pollutant	
0.010	gr/DRY FT3	123.13	TSP

Site Emission Restriction Summary

Emission Limit	Pollutant
----------------	-----------

**SECTION G. Miscellaneous.**

(a) The following sources have been determined to be of minor significance with respect to emissions of air pollutants. They are still subject to 25 Pa. Code Sections 123.2, 123.31, and 123.41, relating to fugitive particulate matter, malodors, and visible emission restrictions, respectively. If the permittee or the SERO determines that particulate matter emissions need to be controlled to comply with Section 123.2, the permittee shall take appropriate measures after approval by the Department pursuant to Section 123.1(c).

- (1) One (1) 2000 gal. Diesel Fuel tank for 20 MMGal. Reservoir.
- (2) One (1) 4000 gal. Diesel Fuel tank for Welded Product #2.
- (3) One (1) 6000 gal. Diesel Fuel tank for Welded Product #2.
- (4) One (1) 275 gal. Fuel Oil tank for Stock Loading Bank.
- (5) One (1) 275 gal. Kerosene tank for Welded Product #2 (N).
- (6) Electric Ovens - Test Lab Research.
- (7) 3-Hydraulic Presses (500, 750 & 5000 ton).
- (8) Three Cold Levelers (NAB, 120" and 160").
- (9) Ethylene Glycol tank.
- (10) 5-Propane Tanks.
- (11) Various Cooling Towers.
- (12) Mechanical Shear.
- (13) Scrap Piles and Handling.
- (14) Hand Grinding throughout Plant.
- (15) Pori and EMS Lime Bin Filters; and "E" Baghouse Dust Bin Filter
- (16) Cooling Sprays - 5 MM Gal. Reservoir.
- (17) Maintenance Portable Blasters.
- (18) Vacuum Degassing.
- (19) Mill Scale Removal and Storage.
- (20) Abrasive Saw.
- (21) NAB, Green Anneal Quench Dip, and Stainless Buildings.
- (22) Machine Cooling Towers (2 Units).
- (23) Grit Blaster (hand held portable).
- (24) Ryman Grinder (2- wet belt grinders).
- (25) Plate Surface Washing.
- (26) Plasma ARC Cutter.
- (27) Welding Machines throughout Plant.
- (28) B&P Grinder (Stainless Finishing Bldg.).
- (29) Flame Cut Products - Grit Blast Baghouse.
- (30) Identification Marking with Paintstik (No VOCs in material).
- (31) ACA Grinders.
- (32) Mold Prep Building.
- (33) Two (2) Hot Levelers (104" and 206").
- (34) Maintenance and Machine Shop.
- (35) Nickel Clad Blasting Room.
- (36) VOD, EAFs, and Ladle Refiner Additive Systems.
- (37) Water-Based Power Washing System.
- (38) Toilet/Incinerator.
- (39) PORI-I - Water Treatment Facility.
- (40) PORI-II - Water Treatment Facility.
- (41) Water Treatment Plant & Associated Waste Handling (Scale, Water, Oil Separation).
- (42) NAB Reservoir (5 MM Gal.) Water Treatment Facility.
- (43) Misc. Plant-Wide Evaporative Water Cooling Towers.
- (44) Fuel Tanks for Mobil Equipment (excluding Source ID: 226).
- (45) South Steel Yard - Misc. Fugitive Emissions Generated from Stockpiling of Materials, Metallurgical Testing Processes, and Removal of Misc. Scrap Protrusions.
- (46) Space Heaters < 1 MMBtu/hr each.
- (47) One (1) 500 gal. Diesel Tank for West End of EMS.
- (48) Nickel Package Boiler
- (49) Plate Blaster #2 Ni Clad and Baghouse
- (50) Cummins Generator (emergency use only), 25 kW (manufactured 10/10/08)
- (51) 140" Reversing Rolling Mill
- (52) 206" 4 High Reversing Rolling Mill

**SECTION G. Miscellaneous.**

(b) The report required in Section C, VIII. Compliance Certification shall be for the period from January 1st through December 31st for the previous year.

(c) The data listed in Sections A, Site Inventory List, for capacity and fuel/material and the source capacity descriptions and permit maps in Section D are for descriptive purposes and are not considered as maximum source capacities or design limitations or enforceable conditions. Source limits are indicated in the text conditions in Section D and E and are listed in Section G of this Title V Operating Permit.

(d) The following previously issued plan approvals and operating permits serve as the basis for certain terms and conditions in this Title V Operating Permit:

- (1) 15-302-082
- (2) 15-302-081A
- (3) 15-307-020B
- (4) 15-307-014
- (5) 15-323-001A&B
- (6) 15-307-022
- (7) 15-307-015
- (8) 15-307-024
- (9) 15-310-040
- (10) 15-323-007
- (11) OP-15-0010
- (12) 15-0010
- (13) 15-0010A
- (14) 15-0010B
- (15) 15-0010C

(e) For purposes of simplification, some sources in this operating permit have been grouped under one source identification number.

(f) The capacities listed in Sections A and D of this operating permit are for information purposes only; they do not represent permit limits or restrictions unless explicitly stated under item I - Restrictions - of Section D - Source Level Requirements.

(g) The emission limits listed in Section F are for summary purposes only; actual enforceable limits are included in Section D.

(h) This Title V Operating Permit (APS No.: 556503, Auth ID: 597016) has been administratively amended to process a Change of Ownership and Responsible Official.

(i) This Title V Operating Permit (APS No.: 560025, AUTH ID: 608453) has been amended to incorporate Plan Approvals 15-0010 and 15-0010A.

(j) This Title V Operating Permit (APS No. : 556503, AUTH ID: 627288) has been renewed and amended to incorporate Plan Approval 15-0010B. In addition, on October 31, 2007, the company submitted a documented notification of a facility name change to 'ArcelorMittal Plate LLC' without a change in ownership or without a change to the federal employee identification number (FEIN).

(k) The following conditions have been revised in the renewed TVOP-15-00010:

- (1) Title/Cover Page: Changed names and titles of the Responsible Official and the Permit Contact.
- (2) Section A, Table of Contents: Removed Emission Trading Groups section (Section F). [Note: Section F is designated as Emission Restriction Summary]
- (3) Sections A, D, and F, Source ID: 037 (2-Small Boilers): Removed this source from operating permit.
- (4) Sections A, D, and F, Source ID: 058 (Nickel Clad Package Boiler): Removed this source and listed it as an insignificant activity in Section G (Miscellaneous).
- (5) Sections A, D, and F, Source ID: 068 (Various Emergency Generators): Changed source name to Emer. Pump 20 MM Gal Reservoir. Changed Source ID No. to 768. The Source Capacity/Throughput data (e.g., 3.40 MMBTU/hr) has been omitted.

**SECTION G. Miscellaneous.**

- (6) Sections A, D, and F, Source ID: 103 (N\ Electric Furnace): Removed this deactivated source from operating permit.
- (7) Sections A, D, and F, Source ID: 151(23 Soaking Pits): Changed the Source Name to 15 Soaking Pits.
- (8) Sections A, D, and F, Source ID: 177 (Vert. Blaster WP#2 Bldg. & Baghouse): Removed this deactivated source from Sections A, D and F.
- (9) Sections A, D, and F, Source ID: 180 (Plate Blaster #2 Ni Clad): Removed this source and listed it as an insignificant activity in Section G (Miscellaneous).
- (10) Sections A and D, Source IDs: C012, C017, C018, C100, C101, C104, C105, C106, C110, C111, C112, and C113: Added these existing control devices as sources with applicable conditions to the operating permit.
- (11) Sections A and D, Source ID: S108 (Corp. Build. Stack): Removed this emission point from the permit maps for Source ID: 037 in Sections A and D.
- (12) Sections A and D, Source ID: S129 (Ni-Clad Boiler Stack): Removed this emission point from the permit maps for Source ID: 058 in Sections A and D.
- (13) Section A and D, Source ID: S141 (2-Arc Bldg. Boilers Stack): Added this emission point to the permit maps for Source ID: 035 in Sections A and D.
- (14) Sections A and D, Source ID: S145 (Soak Pit 37 Stack): Added this emission point to the permit map for Source ID: 151 in Sections A and D.
- (15) Sections A and D, Source ID: S146 (Soak Pit 38/39/40 Stack): Added this emission point to the permit map for Source ID: 151 in Sections A and D.
- (16) Sections A and D, Source ID: S147 (Soak Pit 41/42/43 Stack): Added this emission point to the permit map for Source ID: 151 in Sections A and D.
- (17) Sections A and D, Source ID: S148 (Soak Pit 44/45/46 Stack): Added this emission point to the permit map for Source ID: 151 in Sections A and D.
- (18) Sections A and D, Source ID: S149 (Soak Pit 47/48/49 Stack): Added this emission point to the permit map for Source ID: 151 in Sections A and D.
- (19) Sections A and D, Source ID: S33 (Soak Pit 25/26 Stack): Removed this emission point from the permit map for Source ID: 151 in Sections A and D.
- (20) Sections A and D, Source ID: S34 (Soak Pit 26/27 Stack): Removed this emission point from the permit map for Source ID: 151 in Sections A and D.
- (21) Sections A and D, Source ID: S35 (Soak Pit 29/30 Stack): Removed this emission point from the permit map for Source ID: 151 in Sections A and D.
- (22) Sections A and D, Source ID: S36 (Soak Pit 31/32 Stack): Removed this emission point from the permit map for Source ID: 151 in Sections A and D.
- (23) Sections A and D, Source ID: S51 (Vert. Blast WP #2 Stack): Removed this emission point from the permit map for Source ID: 177 in Sections A and D.
- (24) Sections A and D, Source ID: S54 (#2 NI Clad Blaster Stack): Removed this emission point from the permit map for Source ID: 180 in Sections A and D.
- (25) Sections A and D, Source IDs: C003, C010, C012, , C017, C018, C090, C100, C101, C105, C106, and C113: Added the permit maps for these control devices in Sections A and D.
- (26) Section B, Condition #003: The location of the permit expiration date is now cited to be on Page 1 instead of Page 2.

**SECTION G. Miscellaneous.**

- (27) Section B, Condition #020(b): The address for submission of reports, notifications and other information to the EPA Administrator or EPA Region III has been changed.
- (28) Section C, Condition #007(d) - (g): Added these provisions of the regulatory language for 25 Pa. Code § 129.14.
- (29) Section C, Condition #011(b): The condition has been revised as follows:
- 'The permittee shall annually obtain a certified test from the vendor of each No. 2 fuel oil used in the facility stating the sulfur content, ash content, and BTU rating. The records shall be obtained at the facility for at least five years.'
- (30) Section C, Condition #012(b): Omitted this provision pertaining to CFC containing appliances or MVAC.
- (31) Section C, Condition #013: Added new recordkeeping requirement for asbestos removal.
- (32) Section C, Condition #015: Added this new condition containing the new deviation and compliance certification reporting requirements.
- (33) Section C, Condition #016 (now Condition #018): Revised this condition to incorporate the update version of this regulation (25 Pa. Code § 135.3).
- (34) Section C, Condition #021: Added the new Additional Requirement condition pertaining to the use of propane as a backup fuel.
- (35) Section C, VIII. Compliance Certification: Omitted this provision to submit a certificate of compliance on October 15th of each year.
- (36) Section D, Source IDs: 033, 035, 044, 055, and 056, Condition #002: Added the applicable sulfur oxide emission limit of 25 Pa. Code § 123.22 for these sources.
- (37) Section D, Source ID: 055, Condition #001: Revised this condition to include the regulatory restriction for particulate matter emissions per 25 Pa. Code § 123.11, used for permits issued from this Regional office.
- (38) Section D, Source ID: 055, Conditions #004 and #005: Revised the frequency for monitoring and recordkeeping of fuel usage to monthly.
- (39) Section D, Source ID: 104, Conditions #001 - #007: Added new emission restrictions, throughput restrictions, monitoring, recordkeeping, and Work Practice Standard conditions for this source.
- (40) Section D, Source ID: 136, Condition #001 - #004: Added new emission restrictions, monitoring, recordkeeping, and Additional Requirement conditions for this source.
- (41) Section D, Source ID: 145, Condition #001 - #003: Added new throughput restrictions, monitoring, and recordkeeping conditions for this source.
- (42) Section D, Source ID: 146A, Condition #001: Added a new nitrogen oxides emission limit (33.7 tons per year) for this source.
- (43) Section D, Source ID: 146A, Condition #002: Revised the fuel throughput restriction condition for this source (481.8 million cubic feet per year - natural gas).
- (44) Section D, Source ID: 146A, Conditions #003 and #004: Revised these conditions to require monitoring and recordkeeping of NOx emissions, fuel usage and/or hours of operation on a monthly and 12-month rolling basis, respectively.
- (45) Section D, Source ID: 146A, Conditions #005: Added new requirement for the source to be equipped with a gauge for monitoring the fuel usage.
- (46) Section D, Source ID: 146B, Conditions #001 - #005: Added new NOx emission restrictions, monitoring, recordkeeping and Work Practice Standard conditions for this source.

**SECTION G. Miscellaneous.**

- (47) Section D, Source ID: 151, Condition #003: Added new fuel throughput restriction condition for this source (3,942 million cubic feet of natural gas).
- (48) Section D, Source ID: 151, Condition #005(a) (now Condition #006): Omitted this condition pertaining to the eight 15-MMBTU/hr Soaking Pits.
- (49) Section D, Source ID: 174, Conditions #002 and #003: Revised these conditions to require monthly monitoring and recordkeeping of the hours of operation.
- (50) Section D, Source ID: 176, Condition #001: Revised particulate matter emission limit for this source to 1.09 lbs/hr and 4.09 tons/yr, as a 12-month rolling sum.
- (51) Section D, Source ID: 176, Condition #002: Added new operating hours restriction limit (7,500 hr/yr) for this source. [Note: This condition replaces the existing production throughput restriction condition.]
- (52) Section D, Source ID: 176, Conditions #003 and #004: Added new requirements to monitor and record the hours of operation, on a monthly basis for this source.
- (53) Section D, Source ID: 176, Condition #006: Added new Work Practice Standard condition, replacing existing two (2) Work Practice Standard conditions.
- (54) Section D, Source ID: 176, Condition #007: Added new Additional Requirement condition, replacing existing Additional Requirement condition. [Note: Conditions pertaining to the baghouse (i.e., pressure drop, etc.) have been placed under Source IDs: C012 and C113.]
- (55) Section D, Source ID: 181, Conditions #002 and #003: Revised these conditions to require monthly monitoring and recordkeeping of the fuel usage and production throughput for this source. [Note: Conditions pertaining to the baghouse (i.e. pressure drop, etc.) have been placed under Source ID: C017.]
- (56) Section D, Source ID: 182, Conditions #002 - #004: Conditions pertaining to the baghouse (i.e. pressure drop, etc.) have been placed under Source ID: C018.
- (57) Section D, Source ID: 207, Conditions #001 through #005: All applicable conditions pertaining to the baghouse have been placed under Source ID: C101. [Note: Omitted requirements for monthly monitoring and recordkeeping of the fuel usage or hours of operation.]
- (58) Section D, Source ID: 230, Conditions #004(b) and #005(b): Added as an alternate compliance option the requirement to monitor and record the hours of operation of the VOD Flare (Source ID: C104) on a monthly basis.
- (59) Section D, Source ID: 235, Conditions #004(2), (now Condition #006): Revised this condition to ensure that the pressure differential across the baghouse (Source ID: C105) shall not exceed 10.0 inches water gauge (w.g.).
- (60) Section D, Source ID: 238, Condition #004(b) (now Condition #002): Revised this condition to ensure that the pressure differential across the baghouse (Source ID: C106) shall not exceed 7.0 inches water gauge (w.g.).
- (61) Section D, Source ID: 249, Condition #002(b): Revised this condition to permit certification of the VOC content of the coatings by either manufacturer provided certified product data sheets, material data safety sheets, or by appropriate EPA methods.
- (62) Section D, Source ID: 250, Condition #002(b): Revised this condition to permit certification of the VOC content of the coatings by either manufacturer provided certified product data sheets, material data safety sheets, or by appropriate EPA methods.
- (63) Section D, Source ID: 254, Conditions #002 and #003: Revised this condition to only require monitoring and recordkeeping of the pressure drop across scrubbers associated with this source on a weekly basis.
- (64) Section D, Source ID: 254, Condition #004: Revised this condition to emphasize that the listed operating requirements apply only to the Steel Cladding Process scrubbers.

**SECTION G. Miscellaneous.**

- (65) Section D, Source ID: 254, Condition #004(5) (now Condition #005): Revised this condition to ensure that the pressure differential across each of the Nickel Plating Scrubbers (Source IDs: C110 and C111) shall not exceed 1.5 inches water gauge (w.g.).
- (66) Section D, Source ID: 258, Condition #001: Revised this condition to include a new particulate matter emission limit (1.15 lbs/hr and 4.31 tons/year) for this source.
- (67) Section D, Source ID: 258, Condition #002: Added new applicable particulate matter emission limit (e.g. 25 Pa. Code § 123.11) for this source.
- (68) Section D, Source ID: 258, Condition #003: Added new operation hours restriction limit (7,500 hrs/yr) for this source. [Note: This condition replaces the existing production throughput restriction condition.]
- (69) Section D, Source ID: 263, Conditions #002 and #003: Revised these conditions to require monthly monitoring and recordkeeping of the fuel usage or operating hours for this source.
- (70) Section D, Source ID: 768, Conditions #006 and #007: Added the applicable NOx emission restriction condition of 25 Pa. Code § 129.203, and the NOx emission accountability condition of 25 Pa. Code § 129.204, for stationary internal combustion engines rated at greater than 1,000 horsepower (2.55 MMBTU/hr) located in Bucks, Chester, Delaware, Montgomery or Philadelphia Counties.
- (71) Section D, Source ID: 768, Conditions #006(a) (now Condition #008): Removed the deactivated 250-kW Emergency Generator as a source in this source group.
- (72) Section D, Source ID: C003, Condition #002: Removed the sulfur oxide emission limit provision of 25 Pa. Code § 123.21.
- (73) Section D, Source ID: C003, Condition #003 (now Condition #002): Revised testing requirement to incorporate updated permit language and to allow sixty (60) days instead of thirty (30) for submission of reports to the Department.
- (74) Section D, Source ID: C003, Conditions #003 - #024: Incorporated revised monitoring and recordkeeping conditions to demonstrate compliance with the approved process parameters (e.g., static pressure differential, visible emissions). Incorporated revised monitoring and recordkeeping, reporting, Work Practice Standard and Additional Requirement conditions to demonstrate enhanced control device monitoring has required by the federal Compliance Assurance Monitoring (CAM) Rule of 40 C.F.R 64.
- (75) Section D, Source IDs: C010, C017, C018, C100, C101, C105, C106, Conditions #001 - #005: Included new monitoring, recordkeeping, and Work Practice Standard requirements for the approved process parameters (e.g., static pressure differential, visible emissions).
- (76) Section D, Source IDs: C012, C113, Conditions #001 - #006: Included new particulate emission limit, monitoring, recordkeeping, and Work Practice Standard requirements for the approved process parameters (e.g., static pressure differential, visible emissions).
- (77) Section D, Source ID: C141, Conditions #001 - #008: Incorporated conditions from Plan Approval No. 15-0010B.
- (l) This Title V Operating Permit (APS No. : 560025, AUTH ID: 779975) has been amended to incorporate Plan Approval 15-0010C. This amendment includes the following changes:
- (1) Removal of references to open burning under Section C of the Title V Operating Permit renewal, AUTH ID: 627288, issued on 1/7/08 (Conditions #002, #003, and #007).
 - (2) Removal of the second paragraph of Condition #018 of Section C of the Title V Operating Permit renewal, AUTH ID: 627288, issued on 1/7/08, referring to requesting an extension for the submittal of a source report (now Condition #017 under this authorization).
 - (3) The replacement of control device Source ID: C18 with control device Source ID: C182.
- (m) This Title V Operating Permit (APS No.: 560025, AUTH ID: 797294) has been amended to: 1) adjust the allowable pressure drop range for Source ID: C182; 2) correct administrative errors made under AUTH ID: 779975; and 3) re-incorporate a 250-kW

**SECTION G. Miscellaneous.**

emergency generator into Source ID: 768.

(n) This Title V Operating Permit (APS No.: 560025, AUTH ID: 915692) has been renewed for another 5-year term.

(1) This Title V Operating Permit incorporates the requirements of 40 CFR Part 60, Subpart JJJJ.

(2) This Title V Operating Permit also incorporates the requirements of 40 CFR Part 63, Subparts ZZZZ, YYYYY, CCCCCC, and WWWWWW.

(3) Per this permit renewal, the facility has been approved at this time to do monitoring of odors, visible emissions, and fugitive particulate matter (Section C, Condition #009) on a monthly basis. The Department reserves the right to increase this frequency pursuant to Section C, Condition #009(e).

(o) This Title V Operating Permit (APS No.: 560025, AUTH ID: 1025723) has been amended for the following:

(1) Section C, Permit Condition #011 requires ArcelorMittal to maintain records of all monitoring of "odors." This condition has been revised to be consistent with Condition #009 (under Section C), which requires monitoring only for "odors which may be objectionable."

(2) Section D, Source ID 104: Requirements pertaining to 40 CFR Part 63, Subpart YYYYY, have been revised for clarity sake.

(3) Section D, Source ID 254: The reference to 40 CFR Part 63, Subpart WWWWWW (6W) has been revised to fully include the exemption requirements of Subpart 6W.

(4) Section D, Source IDs 768 and 770: Requirements pertaining to 40 CFR Part 63, Subpart ZZZZ, have been revised for clarity sake.

(5) Section D, Source ID 769: Requirements pertaining to 40 CFR Part 60, Subpart JJJJ, have been revised for clarity sake.

(p) This Title V Operating Permit (APS No.: 560025, AUTH ID: 1163670) has been amended to incorporate Plan Approval No. 15-0010D, which was issued for the replacement of an 8.0-MMBtu ladle pre-heat burner, associated with Ladle Pre-heater (4575-10-B) (Source ID 229A), with a 12.0 MMBtu ladle pre-heat burner.

(q) This Title V Operating Permit (APS No.: 560025, AUTH ID: 1200521) has been renewed for another 5-year term.

(1) This Title V Operating Permit incorporates RACT II (25 Pa. Code §§ 129.96 - 129.100).

(2) This Title V Operating Permit incorporates Plan Approval No. 15-0010E, for the replacement of two ladle preheater burners, for Ladle Preheaters "B" and "D".

(3) Source ID 768 has been renamed to accommodate future exempt emergency generators that would be subject to 40 CFR Part 60, Subpart JJJJ.

(r) APS No. 560025; Authorization No. 1307496: This action is for revisions made to the Title V Operating Permit for the settlement of an appeal. The following items were revised:

(1) Instantaneous NOx and/or VOC emission limits for Source ID Nos. 055 and 104 were removed.

(2) Monthly NOx and VOC emission limits were added to Source ID No. 104.

(3) The condition to operate sources in accordance with manufacturer's specifications and good operating practices was added to Section C (as it appears in previously issued versions of the TVOP for ArcelorMittal Plate, LLC).

(4) Conditions for operating and maintaining sources in accordance with manufacturer's specifications and good operating practices was removed from Source ID Nos. 055, 104, 136, 146A, 146B, 151, 250, and 270.

(5) The annual VOC limit was changed to 9.4 tons per year on a 12-month rolling basis for Source ID No. 250 (Identification Marking) to better represent emissions at the full capacity of the plant.

(6) The language for notification of new sources falling under Source ID No. 183 was changed as follows:

"The permittee shall provide any updates or changes to this list of sources with its renewal application."



***** End of Report *****
